

YKSIRIVISET URAKUULALAAKERIT

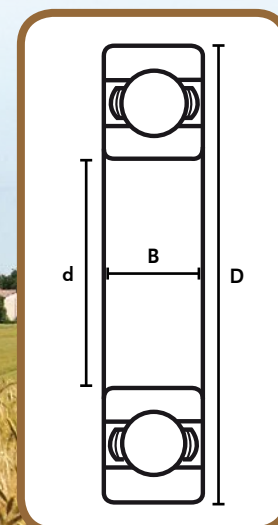

Tuote-numero	Tuotenro FK	d mm	D mm	B mm
L624-2Z	L624-2ZK	4	13	5
L625-2RS	L625-2RSK	5	16	5
L686-2RS		6	13	5
L606-2Z		6	17	6
L626-2RS	L626-2RSK	6	19	6
L607-2RS	L607-2RSK	7	19	6
L627-2RS		7	22	7
L688-2Z		8	16	5
L608-2RS	L608-2RSK	8	22	7
L628-2Z		8	24	8
L609-2RS	L609-2RSK	9	24	7
L629-2RS	L629-2RSK	9	26	8
	L6000-2ZK	10	26	8
L6000-2RS	L6000-2RSK	10	26	8
L6000-2RSC3		10	26	8
L6200-2RS	L6200-2RSK	10	30	9
L6300-2RS	L6300-2RSK	10	35	11
	L6001-2ZK	12	28	8
L6001-2RS	L6001-2RSK	12	28	8
L6001-2RSC3		12	28	8
L6201-2RS	L6201-2RSK	12	32	10
L62201-2RS		12	32	14
L6301-2RS	L6301-2RSK	12	37	12
L6002-2RS	L6002-2RSK	15	32	9
L6202-2RS	L6202-2RSK	15	35	11
L6202-2RSC3		15	35	11
L6302-2RS	L6302-2RSK	15	42	13
L6003-2RS	L6003-2RSK	17	35	10
L6203-2RS	L6203-2RSK	17	40	12
	L6203-2ZK	17	40	12
L6203-2RSC3		17	40	12
L6303-2RS	L6303-2RSK	17	47	14

Tuote-numero	Tuotenro FK	d mm	D mm	B mm
L6004-2RS	L6004-2RSK	20	42	12
L6204-2RS	L6204-2RSK	20	47	14
L6204-2RSC3		20	47	14
L6304-2RS	L6304-2RSK	20	52	15
L6304-2RSC3		20	52	15
L6005-2RS	L6005-2RSK	25	47	12
L6205-2RS	L6205-2RSK	25	52	15
L6205-2RSC3		25	52	15
L6305-2RS	L6305-2RSK	25	62	17
L6305-2RSC3		25	62	17
L6006-2RS	L6006-2RSK	30	55	13
L6006-2RSC3		30	55	13
L6206-2RS	L6206-2RSK	30	62	16
L6206-2RSC3		30	62	16
L6306-2RS	L6306-2RSK	30	72	19
L6306-2RSC3		30	72	19
L6007-2RS	L6007-2RSK	35	62	14
L6007-2RSC3		35	62	14
L6207-2RS	L6207-2RSK	35	72	17
L6207-2RSC3		35	72	17
L6307-2RS	L6307-2RSK	35	80	21
L6307-2RSC3		35	80	21
L6407		35	100	25
L6008-2RS	L6008-2RSK	40	68	15
L6008-2RSC3		40	68	15
L6208-2RS	L6208-2RSK	40	80	18
L6208-2RSC3		40	80	18
L6308-2RS	L6308-2RSK	40	90	23
L6308-2RSC3		40	90	23
L6009-2RS	L6009-2RSK	45	75	16
L6209-2RS	L6209-2RSK	45	85	19
L6209-2RSC3		45	85	19
L6309-2RS		45	100	25
L6309-2RSC3		45	100	25
L6010-2RS	L6010-2RSK	50	80	16
L6210-2RS	L6210-2RSK	50	90	20
L6210-2RSC3		50	90	20
L6310-2RS		50	110	27

2RS - molemmin puolin tiivistelevyt
 2Z - molemmin puolin suojalevyt
 C3 - laakerivälitys suurempi

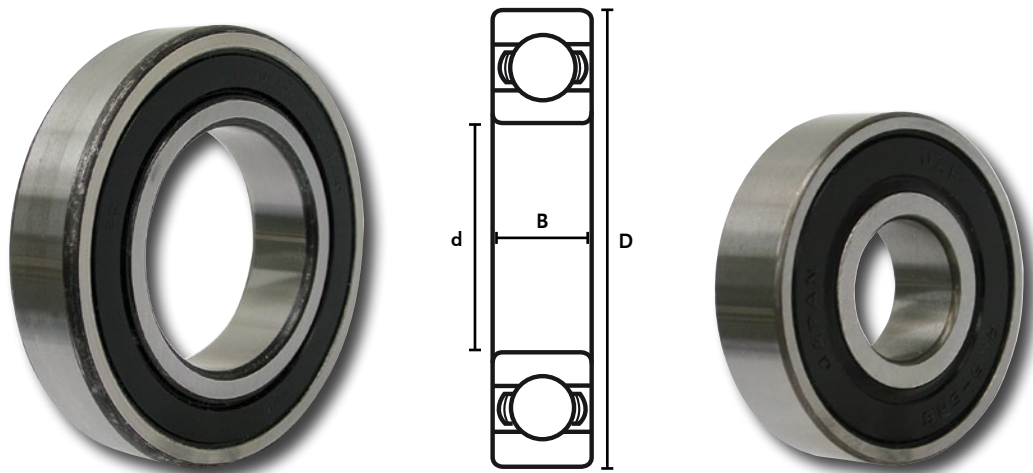

YKSIRIVISET

Tuote-numero	Tuotenro FK	d mm	D mm	B mm
L6011-2RS		55	90	18
L6211-2RS	L6211-2RSK	55	100	21
L6311-2RS		55	120	29
L6012-2RS		60	95	18
L6212-2RS		60	110	22
L6312-2RS		60	130	31
L6013-2RS		65	100	18
L6213-2RS		65	120	23
L6014-2RS		70	110	20
L6214-2RS		70	125	24
L6015-2RS		75	115	20
L6215-2RS		75	130	25
L6016-2RS		80	125	22
L6216-2RS		80	140	26
L6217-2RS		85	150	28
L6020-2RS		100	150	24

KUULALAAKERIT tuumamitoitus

Tuote-numero	d mm	D mm	B mm
LEE4-2RS	12,7	28,575	7,144
LEE5-2RS	15,875	34,925	8,711
LRLS5-2RS	15,875	39,688	11,112
LEE7-2RS	19,05	44,4	12,7

- 2RS - molemmin puolin tiivistelevyt
- 2Z - molemmin puolin suojalevyt
- C3 - laakerivälys suurempi



NIVELLAAKERIT, NIVELVARRET



2RS - molemmin puolin tiivistelevyt

Tuote-numero	Tuotenro FK	FK suojattu	Reikä d mm	Ulko Ø D mm	Leveys sisäkehä B mm	Leveys ulkokehä C mm
	LGE8K		8	16	8	5
LGE10			10	19	9	6
LGE12	LGE12K		12	22	10	7
LGE15	LGE15K		15	26	12	9
LGE17	LGE17K		17	30	14	10
LGE20	LGE20K	LGE20-2RSK	20	35	16	12
LGE25	LGE25K	LGE25-2RSK	25	42	20	16
LGE30	LGE30K	LGE30-2RSK	30	47	22	18
LGE35	LGE35K	LGE35-2RSK	35	55	25	20
	LGEG35K		35	62	35	22
LGE40	LGE40K	LGE40-2RSK	40	62	28	22
LGE45	LGE45K		45	68	32	25
LGE50	LGE50K	LGE50-2RSK	50	75	35	28
LGE60	LGE60K	LGE60-2RSK	60	90	44	36
LGE70	LGE70K		70	105	49	40
	LGE80K		80	120	55	45

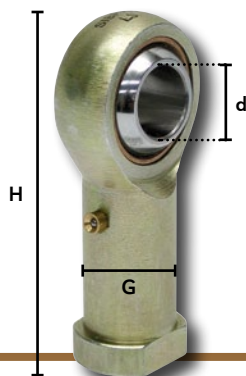

NIVELVARRET

Tuote-numero	d mm	G mm	H mm
LJAF06	6	M6	39
LJAF08	8	M8	47
LJAF10	10	M10	56
LJAF12	12	M12	65
LJAF14	14	M14	74
LJAF16	16	M16	83
LJAF20	20	M20 x 1,5	100
LJAF22	22	M22 x 1,5	109

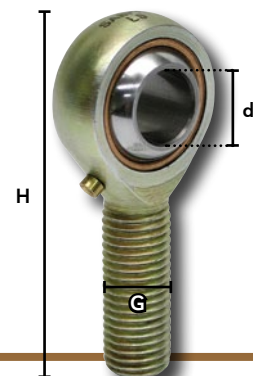

NIVELVARRET

Tuote-numero	d mm	G mm	H mm
LJAM06	6	M6	39
LJAM08	8	M8	47
LJAM10	10	M10	56
LJAM12	12	M12	65
LJAM14	14	M14	74
LJAM16	16	M16	83
LJAM18	18	M18 x 1,5	92
LJAM20	20	M20 x 1,5	100
LJAM25	25	M24 x 2	124

LAAKERIYKSIKÖ PYSTY



Tuote-numero	Tuotenumero FK	Varalaakeri	Varalaakeri FK	d mm	D mm	C mm
LUCP202				15	35	11
LUCP203		LUC203		17	47	17
LUCP204	LUCP204K	LUC204	LUC204K	20	47	17
LUCP205	LUCP205K	LUC205	LUC205K	25	52	17
LUCP206	LUCP206K	LUC206	LUC206K	30	62	19
LUCP207	LUCP207K	LUC207	LUC207K	35	72	20
LUCP208	LUCP208K	LUC208	LUC208K	40	80	21
LUCP209	LUCP209K	LUC209	LUC209K	45	85	22
LUCP210	LUCP210K	LUC210	LUC210K	50	90	23
LUCP211	LUCP211K		LUC211K	55	100	25
LUCP212	LUCP212K	LUC212	LUC212K	60	110	27
	LUCP213K			65	120	29

LAAKERIYKSIKÖ LAIPPA SOIKEA



Tuote-numero	Tuotenumero FK	Varalaakeri	Varalaakeri FK	d mm	D mm	C mm
LUCFL202				15	35	11
		LUC203		17	47	17
LUCFL204	LUCFL204K	LUC204	LUC204K	20	47	17
LUCFL205	LUCFL205K	LUC205	LUC205K	25	52	17
LUCFL206	LUCFL206K	LUC206	LUC206K	30	62	19
LUCFL207	LUCFL207K	LUC207	LUC207K	35	72	20
LUCFL208	LUCFL208K	LUC208	LUC208K	40	80	21
LUCFL209	LUCFL209K	LUC209	LUC209K	45	85	22
LUCFL210	LUCFL210K	LUC210	LUC210K	50	90	23
	LUCFL211K		LUC211K	55	100	25
	LUCFL212K	LUC212	LUC212K	60	110	27

LAAKERIYKSIKÖ LAIPPA NELIÖ

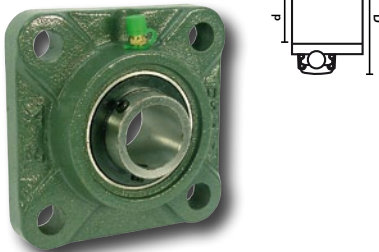

Tuote-numero	Tuotenumero FK	Varalaakeri	Varalaakeri FK	d mm	D mm	C mm
		LUC203		17	47	17
LUCF204	LUCF204K	LUC204	LUC204K	20	47	17
LUCF205	LUCF205K	LUC205	LUC205K	25	52	17
LUCF206	LUCF206K	LUC206	LUC206K	30	62	19
LUCF207	LUCF207K	LUC207	LUC207K	35	72	20
LUCF208	LUCF208K	LUC208	LUC208K	40	80	21
LUCF209	LUCF209K	LUC209	LUC209K	45	85	22
LUCF210	LUCF210K	LUC210	LUC210K	50	90	23
LUCF211	LUCF211K		LUC211K	55	100	25
LUCF212	LUCF212K	LUC212	LUC212K	60	110	27
	LUCF213K			65	120	29

LAAKERIYKSIKÖ LAIPPA PYÖREÄ

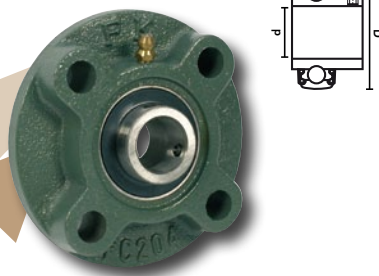

Tuote-numero	Tuotenumero FK	Varalaakeri	Varalaakeri FK	d mm	D mm	C mm
		LUC204	LUC204K	20	47	17
		LUC205	LUC205K	25	52	17
		LUC206	LUC206K	30	62	19
		LUCFC207K	LUC207	35	72	20
		LUCFC208K	LUC208	40	80	21
LUCFC209	LUCFC209K	LUC209	LUC209K	45	85	22
	LUCFC210K	LUC210	LUC210K	50	90	23
			LUC211K	55	100	25
		LUC212	LUC212K	60	110	27

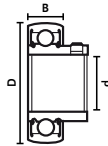

LAAKERIYKSIKKÖ PELTI PYÖREÄ

Tuote-numero	Tuotenumero FK	Varalaakeri	Varalaakeri FK	d mm	D mm	B mm
LUBPF204	LUBPF204K	LUB204	LUB204K	20	47	14
LUBPF205	LUBPF205K	LUB205	LUB205K	25	52	15
LUBPF206	LUBPF206K	LUB206	LUB206K	30	62	16
LUBPF207	LUBPF207K	LUB207	LUB207K	35	72	17



LAAKERIYKSIKKÖ PELTI SOIKEA

Tuote-numero	Tuotenumero FK	Varalaakeri	Varalaakeri FK	d mm	D mm	B mm
LUBPFL202				15	40	12
LUBPFL203		LUB203		17	40	12
LUBPFL204	LUBPFL204K	LUB204	LUB204K	20	47	14
LUBPFL205	LUBPFL205K	LUB205	LUB205K	25	52	15
LUBPFL206	LUBPFL206K	LUB206	LUB206K	30	62	16
LUBPFL207	LUBPFL207K	LUB207	LUB207K	35	72	17
		LUB208		40	80	18

LAAKERIYKSIKÖIDEN VARALAAKERIT

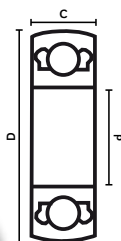

Tuote-numero	d mm	D mm	C mm
L76204-2RS	20	47	14
L76205-2RS	25	52	15
L76206-2RS	30	62	16
L76207-2RS	35	72	17
L76208-2RS	40	80	18
L76209-2RS	45	85	19
L76210-2RS	50	90	20

LAAKERIYKSIKÖIDEN VARALAAKERIT

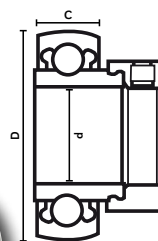

Tuote-numero	d mm	D mm	C mm
L16204	20	47	14
L16205	25	52	15
L16206	30	62	18
L16207	35	72	19
L16208	40	80	21
L16209	45	85	22

LAAKERIYKSIKÖIDEN VARALAAKERIT

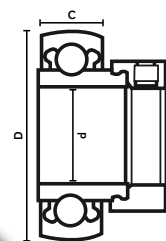

Tuote-numero	d mm	D mm	C mm
LEW205	25	52	15
LEW206	30	62	18
LEW207	35	72	19
LEW208	40	80	21

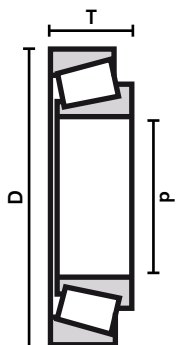

Tuote-numero	d mm	D mm	T mm
L30302	15	42	14,25
L30203	17	40	13,25
L32004	20	42	15,00
L30204	20	47	15,25
L30304	20	52	16,25
L32005	25	47	15,00
L30205	25	52	16,25
L32205	25	52	19,25
L33205	25	52	22,00
L30305	25	62	18,25
L32305	25	62	25,25
L32006	30	55	17,00
L30206	30	62	17,25
L32206	30	62	21,25
L30306	30	72	20,75
L32306	30	72	28,75
L32007	35	62	18,00
L30207	35	72	18,25
L32207	35	72	24,25
L30307	35	80	22,75
L32307	35	80	32,75
L32008	40	68	19,00
L30208	40	80	19,75
L32208	40	80	24,75
L30308	40	90	25,25
L32308	40	90	35,25
L32009	45	75	20,00
L30209	45	85	20,75
L32209	45	85	24,75
L30309	45	100	27,25

Tuote-numero	d mm	D mm	T mm
L30210	50	90	21,75
L32210	50	90	24,75
L30310	50	110	29,25
L32310	50	110	42,25
L32011	55	90	23,00
L30211	55	100	22,75
L32211	55	100	26,75
L32012	60	95	23,00
L30212	60	110	23,75
L32212	60	110	29,75
L32013	65	100	23,00
L33013	65	100	27,00
L30213	65	120	24,75
L32213	65	120	32,75
L32014	70	110	25,00
L32214	70	125	33,25
L32015	75	115	25,00
L30215	75	130	27,25
L32215	75	130	33,25
L32016	80	125	29,00
L30216	80	140	28,75
L32216	80	140	35,25
L32217	85	150	38,50
L32018	90	140	32,00
LJL819349-310	95	135	20,00
VPJ2448	100	145	24,00





KARTIORULLALAAKERIT

Tuote-numero	d mm	D mm	T mm
LM11749-710	17,46	39,88	14,61
LM11949-910	19,05	45,24	16,64
LM72849-810	22,61	47,00	15,50
LL44643-610	25,40	50,29	14,73
LM84548-510	25,40	57,15	19,43
LM44649-610	26,99	50,29	14,73
LM86649-610	30,16	64,29	21,43
LM48548-510	34,93	65,09	18,29
LM501349-310	41,28	73,43	19,59
LK24780-720	41,28	76,20	22,23
LM603049-011	45,24	77,79	19,84
LM806649-610	53,975	88,90	19,05

AKSELIMUTTERIT JA LAATAT

Tuotenumero mutteri	Koko mm	Tuotenumero laatta
KM01	12 x 1,0	MB01
KM03	17 x 1,0	MB03
KM04	20 x 1,0	MB04
KM05	25 x 1,5	MB05
KM06	30 x 1,5	MB06
KM07	35 x 1,5	MB07
KM08	40 x 1,5	MB08
KM09	45 x 1,5	MB09
KM10	50 x 1,5	MB10
KM11	55 x 2,0	MB11
KM12	60 x 2,0	MB12
KM13	65 x 2,0	
KM14	70 x 2,0	

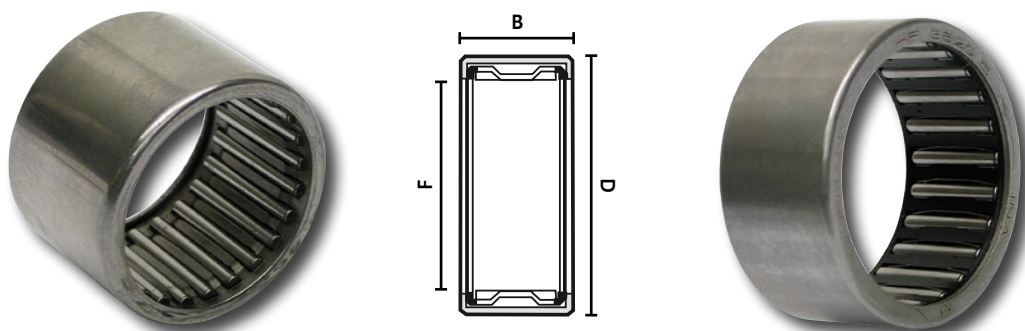

NEULALAAKERIT AUROIHIN

Tuote-numero	F mm	D mm	B mm
LHK3026	30	37	26
LHK3520	35	42	20

LAAKERI STOKERIIN pyörii vain toiseen suuntaan

Tuote-numero	F mm	D mm	B mm
LHF3520B	35	42	20

PALLOMAISET KUULALAAKERIT

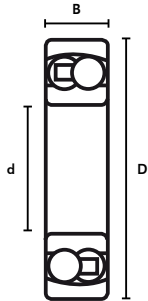

Tuotenro	d mm	D mm	B mm
L1205	25	52	15
L2205	25	52	18
L1206	30	62	16
L1207	35	72	17
L2207	35	72	23
L1208	40	80	18
L1308	40	90	23
L1209	45	85	19
L1309	45	100	25
L1211	55	100	21

KAKSIRIVISET VIISTOKUULALAAKERIT

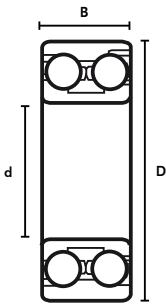

Tuotenro	d mm	D mm	B mm
L3204	20	47	20,6
L3205	25	52	20,7
L3206	30	62	23,9
L3207	35	72	28,0
L3209	45	85	30,3

KAKSIRIVINEN URAKUULALAAKERI

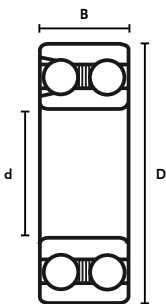

Tuotenro	d mm	D mm	B mm
L4204	20	47	18

LIERIÖ-RULLALAAKERI

LNU206

- d 30 mm
- D 62 mm
- B 16 mm

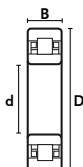

PALLOMAINEN RULLALAAKERI

L22210

- d 50 mm
- D 90 mm
- B 23 mm

