



TRAKTORI-MALLI	MOOTTORI TYYPPI	SYLINTERI-LUKU	SYLINTERIN HALK.
SOM35, SOM45, SOM50	OM CO1D	4	105
SOM40, SOM55	OM CO2D	4	108
SOM511, SOM512	OM CO1D/45	4	105
SOM612, SOM615	OM CO2S	4	108
SOM650	OM CN 3	3	110
SOM670	OM CO 3/60	4	110
SOM715	OM CO 3D/130	4	110
SOM750	OM CO 3/70	4	110
SOM800, SOM805C, SOM880/4	OM CO 3/75	4	110
SOM850	OM CO 3/80	4	110
SOM1300	OM CP3/100	6	110
250, 255, 300	8025.01	2	95
311, 311R, 312, 312R, 315	605D	4	82
350	8025.02	2	100
400, 420, 450, 460, 470	8035.01	3	95
411, 411R, 412, 412R, 415, 421, 431	615D	4	85
440, 446, 450, 455C, 466, 474, 480, 500, 505C	8035.02	3	100
505C SUPER, 565C, 566, 570, 580	8035.04	3	103
540	8035.02D	3	100
550	8045.01	4	95
600, 605C, 640, 665C, 666, 670, 680	8045.02	4	100
766, 780, 855C	8045.04	4	103
880/5, 955C	8055.04	5	103
900	8065.01	6	95
980, 1000	8065.02	6	100
1000S, 1000SUP, 1180	8065.04	6	103
1280, 138	8065.24 TURBO	6	103
1355C	8365.05	6	115
SERIE 46			
1580, 1880	8365.25 TURBO	6	115
55-46	8035.06	3	100
60-46	8035.05	3	104
65-46	8045.06	4	100
SERIE 55			
85-55C	8045.05	4	104
95-55	8055.05	5	104
100-55	8065.06	6	100
160-55C, 180-55C	8365.25 TURBO	6	115
SERIE 56			
55-56	8035.06	3	100
60-56L	8035.05	3	104
65-56L, 70-56L	8045.06	4	100
SERIE 76			
45-76V, 55-76V, 55-76F	8035.06	3	100
60-76F	8035.05	3	104
70-76LP, 70-76F, 70-76V	8045.06	4	100
80-76F	8045.05	4	104
SERIE 85			
55-85CF, 55-85V, 55-85M	8035.06	3	100
60-85CF, 60-85CV, 62-85C, 62-85CM	8035.05	3	104
72-85C, 72-85CM	8045.06	4	100
82-85C, 88-85C	8045.05	4	104
88-85M	8045.25 TURBO	4	104
SERIE 86			
50-86V	8035.06	3	100
60-86V, 60-86F, 62-86F	8035.05	3	104
70-86V, 72-86F, 72-86LP	8045.06	4	100
82-86F, 82-86LP	8045.05	4	104

TRAKTORI-MALLI	MOOTTORI TYYPPI	SYLINTERI-LUKU	SYLINTERIN HALK.
SERIE 88			
55-88	8035.06	3	100
60-88	8035.05	3	104
65-88, 70-88	8045.06	4	100
80-88	8045.05	4	104
SERIE 90			
55-90	8035.06	3	100
60-90	8035.05	3	104
65-90, 70-90	8045.06	4	100
80-90	8045.05	4	104
85-90	8045.25 TURBO	4	104
90-90	8055.05	5	104
100-90	8065.06	6	100
110-90, 115-90	8065.05	6	104
130-90, 140-90	8065.25 TURBO	6	104
160-90, 180-90	8365.25 TURBO	6	115
SERIE 93			
60-93	8035.05	3	104
65-93, 72-93	8045.06	4	100
82-93	8045.05	4	104
88-93	8045.25 TURBO	4	104
SERIE 94			
60-94	8035.05	3	104
65-94, 72-94	8045.06	4	100
82-94	8045.05	4	104
88-94	8045.25 TURBO	4	104
SERIE 65			
55-65F, 55-65V, 55-65M	8035.06	3	100
60-65CM, 60-65CV	8035.05	3	104
70-65C	8045.06	4	100
SERIE 66			
35-66	CHD 1503	3	88
45-66, 45-66V, 50-66S, 55-66	8035.06	3	100
60-66	8035.05	3	104
65-66, 70-66, 70-66LP, 70-66F	8045.06	4	100
80-66, 80-66F	8045.05	4	104
SERIE 75			
55-75CF, 55-75M	8035.06	3	100
60-75CV, 60-75CM	8035.05	3	104
70-75C, 70-75CM	8045.06	4	100
80-75C	8045.05	4	104
SERIE WINNER			
F100 FINO	8065.06	6	100
F100DAL, F110, F120	8065.05	6	104
F115	8065.05R	6	104
F130	8065.25 TURBO	6	104
F140	8065.25 S TURBO	6	104
SERIE L			
L60	8035.05	3	104
L65	8045.06	4	100
L75	8045.05	4	104
L85	8045.25 TURBO	4	104
L95	8045.05K TURBO	4	104
SERIE G			
G170=8670			
G190=8770			
G210=8870			
G240=8970			
SERIE M			
M100=8160			
M115=8260			
M135=8360			
M160=8560			

08.05.2009

Fiat moottorin korjaussarjat STD sisältää:

- männät
- männänrenkaat
- sylinteriputket (puolivalmiit)
- täydellisen tiivistesarjan
- kampiakselin etu- ja takatiivisteet (jos ei kuulu jo tiivistesarjaan)
- kk-laakerit STD
- rk-laakerit STD



K1000



T3131



T3257



T3138

TRAKTORI-MALLI	MOOTTORIN KORJAUS-SARJA STD (a)	TÄYDELLINEN MÄNTÄ	MÄNNÄN-RENGAS-SARJA	SYLINTERI-PUTKI
411, 415		T3167 (d) 1909866	T3170 1909861	T3168 561212
450, 550			T3169 1901496	
500			T3140 1908737	
600, 640	K0200 (c)	T3129 (c, d) 1908744	T3140 1908737	T3136 4653280
650, 750, 850			T3141 1909236	
1000		T3129 (c, d) 1908744	T3140 1908737	T3136 4653280
1000 Super, 580		T3131 1908748	T3142 1909234	T3138 4679201
1300, 1300 Super			T3141 (b) 1909236	
680	K0200	T3129 (d) 1908744	T3140 1908737	T3136 4653280
780	K0201	T3131 1908748	T3142 1909234	T3138 4679201
880-4 syl.			T3141 1909236	
880-5 syl.	K0203	T3131 1908748	T3142 1909234	T3138 4679201
980		T3129 (d) 1908744	T3140 1908737	T3136 4653280
1180		T3131 1908748	T3142 1909234	T3138 4679201
1380				T3138 4679201
1580		T3134 (d) 1901492	T3144 1901487	T3139 2991786
1880, 1580T			T3257 1930753	T3139 2991786

a - sarja sis. putket, männät, renkaat kk. ja rk. laakerit, tiivisteet

b - nelirenkainen

c - palotila keskellä 1978 uudemmissa, männän tapin halk. 32 mm

d - sisältää männänrenkaat

08.05.2009

Fiat moottorin korjaussarjat STD sisältää:

- männät
- männänrenkaat
- sylinteriputket (puolivalmiit)
- täydellisen tiivistesarjan
- kampaakselin etu- ja takatiivisteen (jos ei kuulu jo tiivistesarjaan)
- kk-laakerit STD
- rk-laakerit STD



TRAKTORI-MALLI	MOOTTORIN KORJAUS-SARJA STD	TÄYDELLINEN MÄNTÄ	MÄNNÄN-RENGAS-SARJA	SYLINTERI-PUTKI
55-90, 65-90, 70-90		T3251 (c) 1930241	T3255 1908738	T3319 4770654
60-90, 90-90, 115-90, 110-90		T3252 (c) 1930186	T3256 1930191	T3320 4770623
80-90	K0205	T3252 (c) 1930186	T3256 1930191	T3320 4770623
100-90		T3251 (c) 4770654	T3255 1908738	T3319 4770654
130-90, 140-90		T3253 (b, c) 2991530	T3258 1902687	T3320 4770623
160-90 →26250			T3257 1930753	T3139 2991786
180-90 →26250			T3257 1930753	T3139 2991786
160-90 26251→		T3723 (a) 1930742	T3257 1930753	T3139 2991786
180-90 26251→		T3723 (a) 1930742	T3257 1930753	T3139 2991786
L60, L75		T3252 (c) 1930186	T3256 1930191	T3320 4770623
L65		T3251 (c) 1930241	T3255 1908738	T3319 4770654

a - palotila viistetty venttiilien puolelta

b - uusi mäntä vahvistettu yläpäästään siten, että kiertokangen yläpäättä on kavennettava

c - sisältää männänrenkaat

26.09.2011

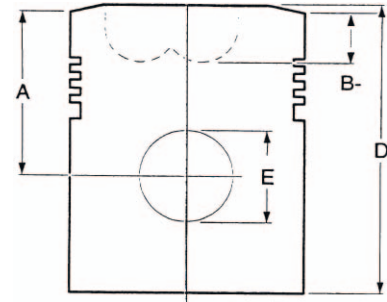
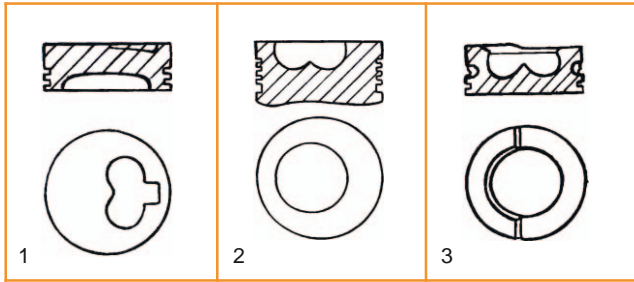



























- A Männän keskiökorkeus mm
- B - Palotilan syvyys mm
- D Kokonaispituus mm
- E Männän tapin Ø mm
- F Männän tapin pituus mm

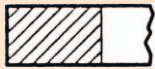

TUOTE- NUMERO	MOOTTORI- TYYPPI	Ø	MALLI	KPL	TERÄS- VAHVIST.	A	B-	D	E	F
T3167 1909866	615D	85	1	4		50,3	4,5	90	28	74,4
	8025.01 8035.01 8045.01	95	2	3		59,6	23,5	101,5	32	84
	8025.02 8035.02 8045.02 8065.02	100	2	3		59,6	23,7	101,15	32	84
T3251 1930241	8035.06 8045.06 8065.06	100	2	3		65,15	22,7	108,5	38	85
T3131 1908748	8035.04 8045.04 8055.04 8065.04	103	2	3		59,6	22,7	101,15	34	90
T3252 1930186	8035.05 8045.05 8055.05 8065.05	104	2	3		65,15	22,5	108,5	38	85
T3253 1930206	8045.25 8065.25	104	2	3	kyllä	65,15	22,5	108,5	38	89
T3723 1930742	8361.45	115	3	3	kyllä	76,5	27,7	140,5	42	97

26.09.2011

TUOTE- NUMERO	MOOTTORI- TYYPPI	Ø mm				
T3169 1901496	8025.01 8035.01 8045.01	95	 2,5	 2,5	 5,5	
T3140 1909172	8025.02 8035.02 8045.02 8065.02	100	 2,5	 2,5	 5,5	
T3142 1909234	8035.04 8045.04 8055.04 8065.04	103	 2,5	 2,5	 4,0	
T3256 1930191	8035.05 8045.05 8055.05 8065.05	104	 2,5	 2,5	 4,0	
T3255 1930169	8035.06 8045.06 8065.06	100	 2,5	 2,5	 4,0	
T3170 1909861	615D	85	 3,0	 3,0	 3,0	 5,5
T3258 1930209	8045.25 8065.25	104	 3,0	 2,5	 4,0	
	8065.25	104	 3,0	 2,5	 4,0	
T3257 1930753	8365.25	115	 3,0	 2,5	 4,0	

04.02.2008

- A - nimellishalkaisija mm
- B - ulkohalkaisija mm
- C - laipan halkaisija mm
- D - laipan vahvuus mm
- E - kokonaispituus mm

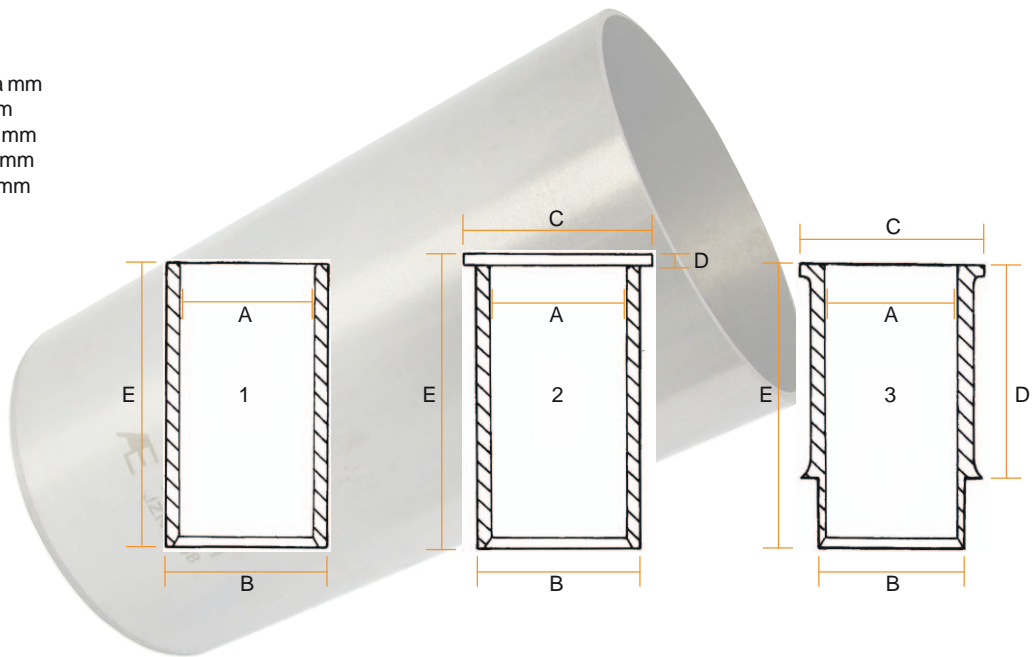

TUOTE- NUMERO	MALLI	A mm	B mm	C mm	D mm	E mm
T3168 561212	1	85	90,4			178
	1	95	99,1			187
T3136 4653280	1	100	103,06			187
T3319 4770654	1	100	103,06			196
T3138 4679201	1	103	107,1			187
T3320 4770623	1	104	107,1			198
	2	104	107,05	109,87	5	198
T3139 4850230	3	115	122	129,7	167	235

20.05.2011

600, 640

- kansitiiviste tilattava erikseen FT98472008

T3129	Mäntä	4 kpl
T3136	Sylinteriputki	4 kpl
T3232	Tiivistesarja	1 kpl
T3259	Jakopään stefa	1 kpl
T3263	Takastefa	1 kpl
T3145	KK-laakeripari STD	4 kpl
T3279	RK-laakeripari STD	5 kpl

780

- kansitiiviste tilattava erikseen FT98456215

T3131	Mäntä	4 kpl
T3138	Sylinteriputki	4 kpl
T3233	Tiivistesarja	1 kpl
T3145	KK-laakeripari STD	4 kpl
T3279	RK-laakeripari STD	5 kpl

80-90

- kansitiiviste tilattava erikseen FT98456215

T3152	Mäntä	4 kpl
T3320	Sylinteriputki	4 kpl
T3239	Tiivistesarja	1 kpl
T3259	Jakopään stefa	1 kpl
T3263	Takastefa	1 kpl
T3266	KK-laakeripari STD	4 kpl
T3283	RK-laakeripari STD	5 kpl

26.09.2011



T3145



T3279



T3276

TRAKTORI-MALLI	KIERTOKANGEN LAAKERI-PARI (a)	RUNKO-LAAKERI-PARI (a)	PÄITTÄIS-LAAKERI-SARJA
640	T3145 x 4 1901609	T3279 x 5 1901803	T3275 (e) 1909996 T3276 (b) 1901377
640	T3145 x 4 1901609	T3279 x 5 1901803	T3275 (e) 1909996 T3276 (b) 1901377
780	T3145 x 4 1901609	T3279 x 5 1901803	T3275 (e) 1909996 T3276 (b) 1901377
750, 880 - 4 syl.	T3146 x 4 1901614		T3277 1901624
1000 Super, 980, 1180 6 syl.	T3145 x 6 1901609	T3279 x 7 1901803	T3276 (b) 1901377



T3145



T3279



T3276



T3270

TRAKTORI-MALLI	KIERTOKANGEN LAAKERI-PARI (a)	RUNKO-LAAKERI-PARI (a)	TÄYD. RUNKO-LAAKERI-SARJA (a)	PÄITTÄIS-LAAKERI-SARJA	KIERTOKANGEN HELA
312, 315	T3285 1909905				
411, 415, 441			T3288 1909893	T3290 902302	
450, 550	T3145 1901609	T3279 1901803		T3275 1909996	
600, 640	T3145 1901609	T3279 1901803		T3276 (b) 1901377	
650	T3146 1901614		T3292 1909459	T3277 1901624	
750, 850	T3146 1901614			T3277 1901624	
1000	T3145 1901609	T3279 1901803		T3275 1909996	
1000 Super	T3145 1901609	T3279 1901803		T3276 1901377	T3270 (d) 4754066
1300, 1300 Super	T3146 1901614		T3281 1901244	T3277 1901624	

a - myös alikokolaakereita

b - vuosimallista 1977 eteenpäin

d - mitat: T3270 37,9 x 34 mm

e - vuosimallit 1971-1976

25.07.2008

Huom.

T3282 runkolaakerisarja:
Tarkista öljyreikien sijainti!
(ks. kuva alla)

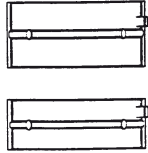

T3145



T3283



T3278



T3270

TRAKTORI- MALLI	KIERTO- KANGEN LAAKERI- PARI (e)	RUNKO- LAAKERI- PARI (e)	TÄYD. RUNKO- LAAKERI- SARJA (e)	PÄITTÄIS- LAAKERI- SARJA	KIERTO- KANGEN HELA (g)
580	T3145 1901609	T3279 1901803		T3275 (h) 1909996 T3276 (f) 1901377	T3270 4754066
680	T3145 1901609	T3279 1901803		T3275 (h) 1909996 T3276 (f) 1901377	
780	T3145 1901609	T3279 1901803		T3275 (h) 1909996 T3276 (f) 1901377	T3270 4754066
880, 4-syl.	T3146 1901614			T3277 1901624	
880, 5-syl.	T3145 1901609	T3279 1901803		T3276 1901377	T3270 4754066
980	T3145 1901609	T3279 1901803		T3276 1901377	
1180, 1380	T3145 1901609	T3279 1901803		T3276 1901377	T3270 4754066
1580, 1880 1580 turbo	T3147 (c) 1901619		T3282 1901832	T3278 1901385	T3272 (b) 4771030
55-90, 60-90, 65-90, 70-90	T3266 1930181	T3283 1930176		T3278 1901385	T3273 4766404
80-90, 90-90, 100-90	T3266 1930181	T3283 1930176		T3278 1901385	T3273 4766404
115-90, 130-90	T3266 1930181	T3283 1930176		T3278 1901385	T3273 4766404
140-90	T3267 1930201	T3283 1930176		T3278 1901385	T3274 4783226
160-90, 180-90	T3268 (d) 1901993 tai T3147 (c) 1901619		T3282 1901832	T3278 1901385	T3272 4771030

b - 1580 moottorinnumerosta 702097→, 1880 moottorinnumerosta 750749→

c - **T3147** varustettu öljyreillä moottorin numeron →702096

d - **T3268** ilman öljyreikää moottorin numerosta 702097→

e - myös alikolaakerit

f - vuosimallista 1977→

g - mitat: 37,9 x 34 mm

h - vuosimallit 1971-1976

04.03.2011

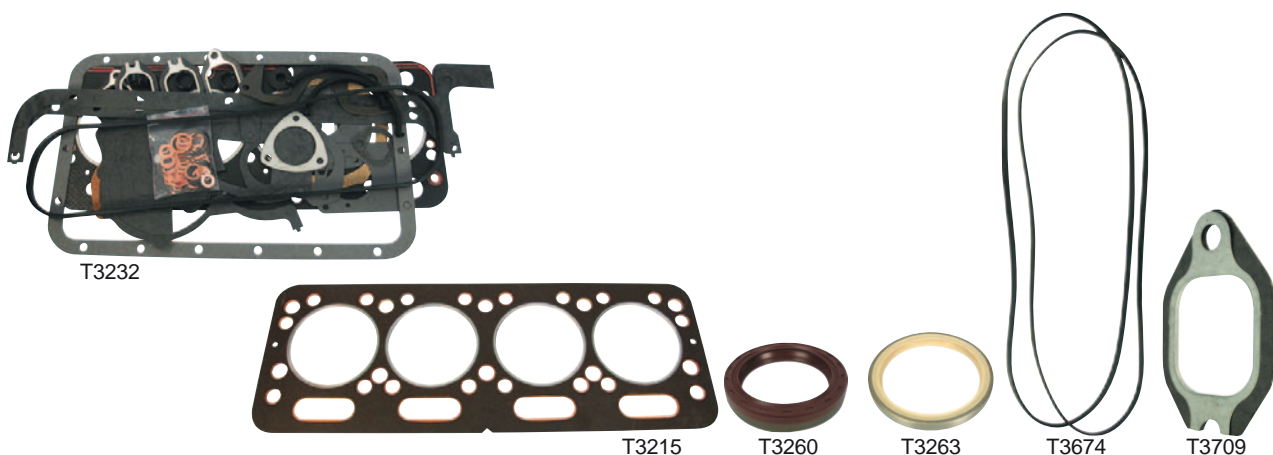

TRAKTORI-MALLI	TÄYD. TIIVISTE-SARJA (H)	KANNEN-TIIVISTE	KAMPI-AKSELIN ETU-STEFA	KAMPI-AKSELIN TAKA-STEFA	VENTTIILI-KANNEN TIIVISTE	PAKO-SARJAN TIIVISTE
411, 415, 441	T3294 (e,f)	T3297				
450			T3259 98461684	T3262 (a) 40000720		
640	T3232 (e,f) 1909567	FT98472008 98472008	T3259 98461684	T3262 (a) 40000720 T3263 (b) 40002811 T3265 (d) 98461686	T3672 4654363	T3709 4601981
650	T3318 (e,f) 1909565		T3260 40101393			
750		T3215 8818558	T3260 38819123		T3675 8816531	
850		T3215 8818558	T3260 38819123		T3675 8816531	
1000		FT98472010 98472010	T3259 98461684	T3262 (a) 40000720 T3263 (b) 40002811	T3674 4628453	T3709 4601981
1000 Super		FT98456219 (c) 98456219	T3259 98461684	T3263 (b) 40002811	T3674 4628453	T3709 4601981
1300			T3260 38819123		T3676 8829321	
1300 Super			T3260 38819123		T3676 8829321	

- a - 95 x 120 x13
- b - 110 x 135 x 13
- c - vaihtoehto alkuperäinen **FT98456219**
- d - 114 x 135 x 13
- e - sarja ei sis. kampiakselin takapään stefaa
- f - sarja ei sis kampiakselin etupään stefaa
- h - sarja ei sisällä kannentiivistettä

22.10.2010

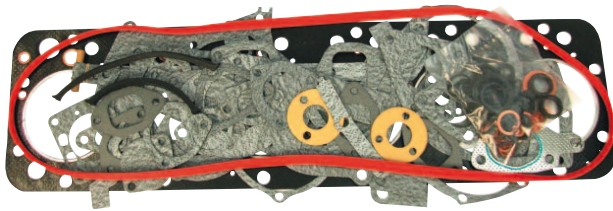

T3249

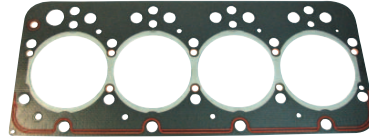

T3220



T3259



T3265



T3674



T3709

TRAKTORI-MALLI	TÄYD. TIIVISTE-SARJA (H)	KANNEN-TIIVISTE	KAMPI-AKSELIN ETU-STEFA	KAMPI-AKSELIN TAKA-STEFA	VENTTIILI-KANNEN TIIVISTE	PAKO-SARJAN TIIVISTE
580		T3216 4708955	T3259 98461684	T3263 (c) 40002811	T3671 4783243	T3709 4601981
680	T3232 (e,f) 1909567	FT98472008 98472008	T3259 98461684	T3263 (c) 40002811	T3672 4654363	T3709 4601981
780	T3233 1909983	FT98456215 98456215	T3259 98461684	T3263 (c) 40002811	T3672 4654363	T3709 4601981
880, 4-syl.		T3215 8818558	T3260 8831405		T3675 8816531	
880, 5-syl.			T3259 98461684	T3263 (c) 40002811	T3673 4783242	T3709 4601981
980		FT98472010 98472010	T3259 98461684	T3263 (c) 40002811	T3674 4628453	T3709 4601981
1180	T3245 (e,f) 1909543	FT98456219 (a) 98456219	T3259 98461684	T3263 (c) 40002811	T3674 4628453	T3709 4601981
1380		FT98456219 (a) 98456219	T3259 98461684	T3263 (c) 40002811	T3674 4628453	T3709 4601981
1580		FT4845364 4845364	T3260 8831405	T3264 40101400	T3676 8829321	
1880		FT4845364 4845364	T3260 8831405	T3264 40101400	T3676 8829321	
55-90			T3259 98461684	T3265 (d) 98461686	T3671 4783243	T3709 4601981
60-90			T3259 98461684	T3265 (d) 98461686	T3671 4783243	T3709 4601981
70-90, 65-90		FT98472008 98472008	T3259 98461684	T3265 (d) 98461686	T3672 4654363	T3709 4601981
80-90	T3239 (e,f) 1930248	FT98456215 98456215	T3259 98461684	T3265 (d) 98461686	T3672 4654363	T3709 4601981
90-90		FT1940075 1940075	T3259 98461684	T3265 (d) 98461686	T3673 4783242	T3709 4601981
100-90	T3249 (e,f) 1930859	FT98472010 98472010	T3259 98461684	T3265 (d) 98461686	T3674 4628453	T3709 4601981
115-90, 130-90, 140-90	T3250 (e,f) 1940051	FT98456219 98456219	T3259 98461684	T3265 (d) 98461686	T3674 4628453	
160-90, 1580 turbo	T3669 1930369	FT4845364 4845364	T3260 8831405	T3264 40101400	T3676 8829321	
180-90		FT4845364 4845364	T3260 8831405	T3264 40101400	T3676 8829321	
110-90	T3250 (e,f) 1940051	FT98456219 (a) 98456219	T3259 98461684	T3265 (d) 98461686	T3674 4628453	T3709 4601981
F110, 115, 120, 130	T3250 (e,f) 1940051	FT98456219 (a) 98456219	T3259 98461684	T3265 (d) 98461686	T3674 4628453	
F140		FT98456219 (a) 98456219	T3259 98461684	T3265 (d) 98461686	T3674 4628453	

a - vaihtoehto alkuperäinen **FT98456219**

c - 110 x 135 x 13

d - 114 x 135 x 13

e - sarja ei sis. kampiakselin takapään stefaa

f - sarja ei sis kampiakselin etupään stefaa

h - sarja ei sisällä kannentiivistettä

C1.10

Alkuperäisnumerot ovat ainoastaan vertailua varten, eivätkä tarkoituksena, että tuotteet ovat alkuperäisiä. Taulukoissa esiintyvät kuvat ovat viitteellisiä.

06.10.2006



T3311



T3312



T3315



T3727

TRAKTORI-MALLI	IMU-VENTTIILI	PAKO-VENTTIILI	IMU-OHJURI	PAKO-OHJURI	VENTTIILIN JOUSI
411, 412, 415, 421, 431	T3303 4579416	T3304 4579417			
450, 550, 600, 640, 1000, 1000 Super	T3299 4621511	T3300 4673608	T3315 4684422	T3315 4684422	T3726 4689554
650, 750, 850	T3301 8823545	T3302 8823544	T3316 4758794	T3317 4758798	
1300, 1300 Super		T3302 8823544	T3316 4758794	T3317 4758798	
580, 680, 780, 880 5-syl., 980, 1180	T3299 4621511	T3300 4673608	T3315 4684422	T3315 4684422	T3726 4689554
880 4-syl.	T3301 8823545	T3302 8823544	T3316 4758794	T3317 4758798	
1380	T3307 4621511	T3308 4673608	T3315 4684422	T3315 4684422	
1580, 1880, 1580T	T3309 4821709	T3310 8830045	T3316 4758794	T3317 4758798	
55-90, 60-90, 65-90, 70-90, 80-90, 85-90, 90-90, 100-90, 110-90, 115-90, 130-90, 140-90	T3311 4824417	T3312 4784889	T3315 4684422	T3315 4684422	T3727 4780108
160-90, 180-90	T3309 4821709	T3310 8830045	T3316 4758794	T3317 4758798	

08.05.2009



7 hyvää syytä
vaihtaa uudet suutinkärjet:

1. säästät polttoainetta
2. pidempi moottorin käyttöikä
3. puhtaammat päästöt
4. lisää tehoa
5. enemmän vääntöä
6. parempi käynnistyvyys
7. tasaisempi käynti



SD72061



T3115



T3063

TRAKTORI- MALLI	SUUTTIMEN KÄRKI	VERTAILU- NUMERO	MOOTTORIN ÖLJYPUMPPU	ÖLJY- KELLO
450, 640	SD72031 4760843	DLL140S64F	T3115 4705827	T3063 4151243
850	SD72024 4758260	DLL150S51F		
1000	SD72031 4760843	DLL140S64F		T3063 4151243
1300	SD72024 4758260	DLL150S51F		T3063 4151243
580, 680, 780	SD72031 4760843	DLL140S64F	T3115 4705827	T3063 4151243
880 4-syl.	SD72024 4758260	DLL150S51F		T3063 4151243
880 5-syl., 980, 1180	SD72031 4760843	DLL140S64F		T3063 4151243
1380	SD72031 4760843	DLL140S64F		T3063 4151243
1580, 1880, 1580T	SD72039 4750416	DLL145S73F		T3063 4151243
55-90, 70-90	SD72060 4791689	DLL124S500W	T3115 4705827	T3063 4151243
60-90, 80-90	SD72061 4776715	DLL136S501W	T3115 4705827	T3063 4151243
90-90, 100-90, 115-90, 130-90, 140-90	SD72061 4776715	DLL136S501W DLL136S1000	T3353 4770250	T3063 4151243
160-90, 180-90	SD72039 4750416	DLL145S73F		T3063 4151243
F100, F110, F120, F130, F140		DLLA137S1208	T3353 4770250	T3063 4151243
446, 450, 45-66, 460, 466, 470, 480, 480-8F, 500, 50-66, 540, 550, 55-66, 55-66F, 55-76F, 55-90, 566, 570, 580, 600, 60-60, 60-66, 60-66F, 60-76F, 60-90, 60-93, 60-94, 640, 65-66, 65-90, 65-93, 65-94, 666, 670, 680, 70-66, 70-66F, 70-76F, 70-90, 72-93, 72-94, 766, 780, 80-66, 80-66F, 80-76F, 80-90, 82-93, 82-94			T3115 4705827	
110-90, 55-65, 55-66, 55-90, 60-65, 60-90, 65-90, 70-65, 70-90, 80-65, 80-66, 80-90, 85-55, 90-90, 95-55				T3063 4151243

08.01.2007

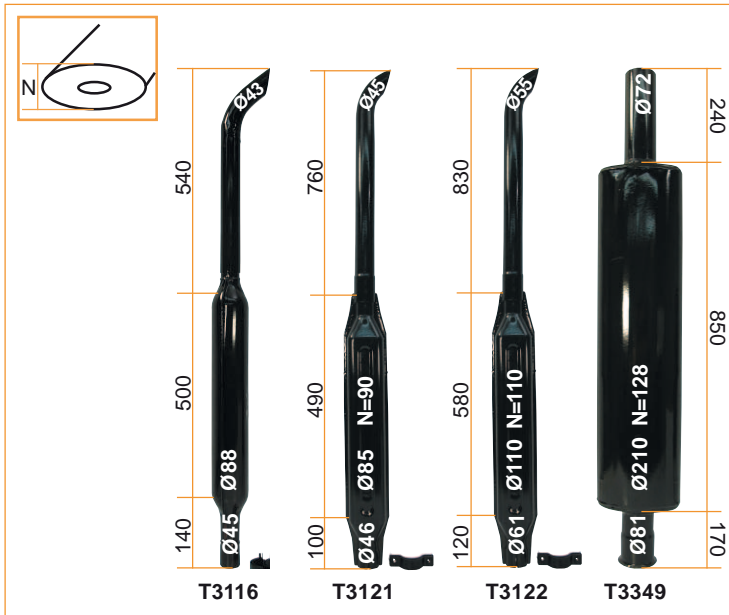

TRAKTORI-MALLI	PAKO-PUTKI	PAKO-PUTKEN SIDE	POLTTO-AINE-TANKIN KORKKI	POLTTO-AINE-TANKIN ANTURI	POLTTO-AINEEN SIIRTOPUMPPU	IMU-SARJAN HEHKUTULPPA
450, 640	T3116 5011631		T3344 5118532		T3113 4757883	T3062 5161845
750	T3122 (b) 5101811	T3614 5116798	T3344 5118532		T3183 (a) 763150	
850	T3122 (b) 5101811	T3614 5116798			T3183 (a) 763150	
1000	T3122 (b) 5101811	T3614 5116798			T3114 4709284, 4757884	T3062 5161845
1300	T3122 (b) 5101811	T3614 5116798	T3061 5105346		T3183 (a) 763150	T3062 5161845
580, 680, 780	T3121 4997328	T3613 5116798	T3061 5105346	T3024 5136771	T3113 4757883	T3062 5161845
880 4-syl., 880 5-syl., 980	T3122 (b) 5101811	T3614 5116798	T3061 5105346	T3024 5136771	T3114 4709284, 4757884	T3062 5161845
1180	T3122 (b) 5101811	T3614 5116798	T3061 5105346	T3334 5136772	T3114 4709284, 4757884	T3062 5161845
1380	T3122 (b) 5101811	T3614 5116798	T3061 5105346	T3334 5136772	T3342 4709284	T3062 5161845
1580	T3349 5109906		T3061 5105346	T3334 5136772	T3183 (a) 763150	T3062 5161845
1880 160-90, 180-90	T3349 5109906		T3061 5105346	T3334 5136772		T3062 5161845
55-90, 60-90, 70-90, 80-90, 65-90	T3121 4997328	T3613 5116798	T3061 5105346	T3024 5136771	T3113 4757883	T3062 5161845
90-90, 100-90, 110-90	T3122 (b) 5101811	T3614 5116798	T3061 5105346	T3024 5136771	T3114 4709284, 4757884	T3062 5161845
115-90	T3122 (b) 5101811	T3614 5116798	T3061 5105346	T3024 5136771		T3062 5161845
130-90, 140-90	T3122 (b) 5101811	T3614 5116798	T3061 5105346	T3334 5136772		T3062 5161845
F100, F110, F120, F130					T3728 98419724	T3062 161845
L60, L65, L75, L85, L95 TL65, TL70, TL80, TL90, TL100					T3113 4757883	

a - lasikuppi siirtopumpuun **T5113** Ø 39 mm, kork. 52 mm
b - **T3122A** pakoputken yläosa suora

LASIKUPPI

V299



SIIRTOPUMPPU

F82006984

82006984
- sähköinen
- sopii M100, M115, M135, M160



22.10.2010

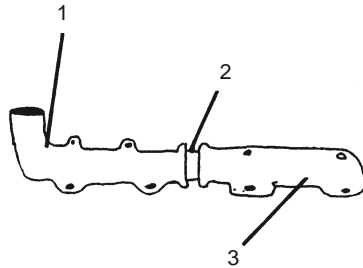

TRAKTORI-MALLI	1 ETUOSA	2 VÄLIHOLKKI	3 TAKAOSA
980, 1180, 100-90, 110-90	T3124 4717758	T3125 4602270	T3123 4817497
880-5 syl., 90-90, 115-90	T3124 4717758	T3125 4602270	

VESI-PUMPUT

T3054

566997
- 411, 415



T3055

4679242
- 450, 500, 550, 600, 640,
1000, 480, 880 5-syl.,
980, 1180, 1380



T3198

8829787
- 650, 750, 850

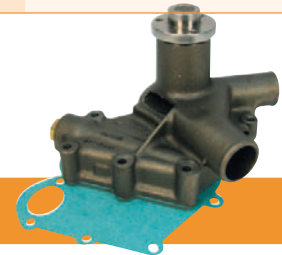

T3195

4696707
- 580, 680, 780



T3197

8829790
- 880 4 syl.



T3200

4796534
- 1580, 1880, 160-90,
180-90

Huomio!
Tarkistathan
mitat!



F0664

87802496
- TM120, TM130, TM140,
TM155, TM175, TM190
- vesipyörän Ø 126 mm



T3196

4784454, 98403016,
4813370
- →12/92:45-66, 50-66, 55-46,
55-65, 55-66, 55-90, 60-46,
60-65, 60-66, 60-90, 65-46,
65-66, 65-90, 70-65, 70-66,
70-90, 80-65, 80-66, 80-90,
85-55, 90-90, 95-55,
100-90, 115-90, 130-90,
140-90, F100, F110, F115,
F120, F130, F140



T3685

98465322, 98497117
- 01/93→12/95:
45-66, 50-66, 55-46,
55-65, 55-66, 55-90, 60-46,
60-65, 60-66, 60-90, 65-46,
65-66, 65-90, 70-65, 70-66,
70-90, 80-65, 80-66, 80-90,
85-55, 90-90, 95-55,
100-90, 115-90, 130-90,
140-90, "76", "86", "93",
"94", F100, F110, F115,
F120, F130, F140



T3756

8013363, 99454833
- 01/96→:
45-66, 50-66, 55-46,
55-65, 55-66, 55-90, 60-46,
60-65, 60-66, 60-90, 65-46,
65-66, 65-90, 70-65, 70-90,
80-65, 80-66, 80-90, 85-55,
90-90, 95-55, 100-90,
115-90, 130-90, 140-90,
TN65F, TN75F, TN90F, "76",
"86", "93", "94",
L60, 65, 75, 85, 95 (95→),
TL70, 80, 90, 100 (98→),
TN55, 65, 75, 90 (98→)

Huomio!
Tarkistathan
mitat!



F0665

87801641
- M100, M115, M135, M160,
TM115, TM125, TM135,
TM150, TM165
- vesipyörän Ø 115 mm

25.07.2008



T3754



T3692



T3692A



TRAKTORI-MALLI	VESI-PUMPUN KORJAUSSARJA	TERMOSTAATTI	LAIPPA VESIPUMPUN JA TERMOST. VÄLIIN	TIIVISTE O-RENGAS
311, 312, 315	T3212 589323	T2041 4086415		
411, 415	T3056 1909619	T2041 4086415		
450, 500, 550, 600, 640		T3754 4569187	T3691 4615794	T3691A 4673810 T3691B 024600
650, 750, 850		T3209 8826010		
1000		T3754 4569187	T3691 4615794	T3691A 4673810 T3691B 024600
480		T3754 4569187	T3691 4615794	T3691A 4673810 T3691B 024600
580, 680, 780		T3754 4569187	T3691 4615794	T3691A 4673810 T3691B 024600
880 4-syl.		T3209 8826010		
880 5-syl., 980, 1180, 1380		T3754 4569187	T3691 4615794	T3691A 4673810 T3691B 024600
1580, 1880		T3208 4808727		
160-90, 180-90		T3208 4808727		
→ 12/92: 45-66, 50-66, 55-46, 55-65, 55-66, 55-90, 60-46, 60-65, 60-66, 60-90, 65-46, 65-66, 65-90, 70-65, 70-66, 70-90, 80-65, 80-66, 80-90, 85-55, 90-90, 95-55, 110-90, 100-90, 115-90, 130-90, 140-90, F100, F110, F115, F120, F130, F140		T3754 4569187	T3692 4770247	T3692A 4848840 T3692B
01/93→12/95: 45-66, 50-66, 55-46, 55-65, 55-66, 55-90, 60-46, 60-65, 60-66, 60-90, 65-46, 65-66, 65-90, 70-65, 70-66, 70-90, 80-65, 80-66, 80-90, 85-55, 90-90, 95-55, 100-90, 110-90, 115-90, 130-90, 140-90, 76-, 86-, 93- ja 94-sarjat, F100, F110, F115, F120, F130, F140		T3754 4569187		
01/96→: 45-66, 50-66, 55-46, 55-65, 55-66, 55-90, 60-46, 60-65, 60-66, 60-90, 65-46, 65-66, 65-90, 70-65, 70-90, 80-65, 80-66, 80-90, 85-55, 90-90, 95-55, 100-90, 110-90, 15-90, 130-90, 140-90, TN65F, TN75F, TN90F, 76-, 86-, 93- ja 94-sarjat, L60, L65, L75, L85, L95 (95→), TL70, TL80, TL90, TL100 (98→), TN55, TN65, TN75, TN90 (98→)		T3754 4569187		
M100, M115, M135, M160		VPE3405 87800842		

06.10.2006



T3615

4973345, 4952981,
4952983, 4956666

- sopivuus:

480, 500, 540, 550, 600, 640

55-56, 55-66, 55-88, 60-56, 60-66, 60-75, 60-88,

90-93, 60,94, 65-56, 65-66, 65-88, 65-93, 70-56,

70-66, 70-88, 72-93

- 4-rivinen

- kokonaiskorkeus 660 mm

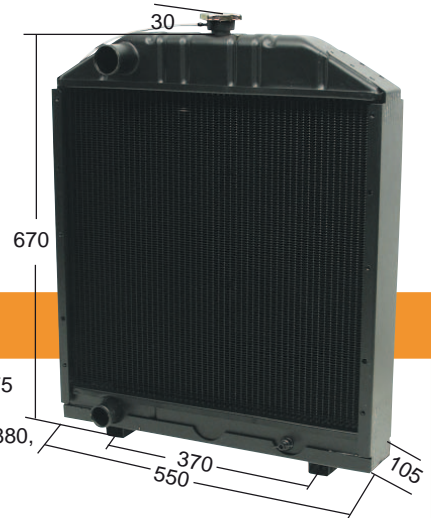

T3724

5143883, 4997175

- sopivuus:

580, 680, 780, 880,

55-90, 60-90,

65-90, 70-90,

80-90

- 3-rivinen

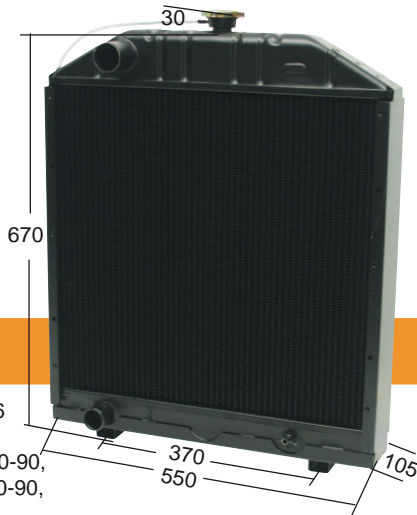

T3725

5143884, 4997926

- sopivuus:

780, 880, 980, 60-90,

70-90, 80-90, 90-90,

100-90, 110-90

- 4-rivinen

- kokonaiskorkeus 700 mm



T3757

5119698, 5123209,

5123208, 5129229

- sopivuus: 1580, 1880,

130-90, 140-90,

160-90, 180-90

- kokonaiskorkeus 865 mm

25.07.2008



AVX10-1000

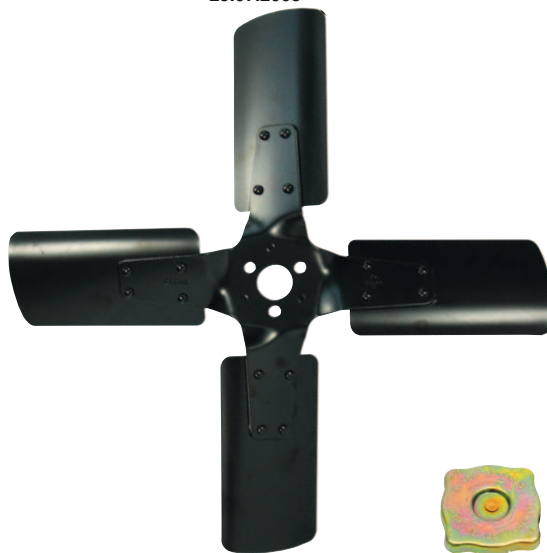

T3374



T3360



T4013

Katso tuulettimen hihnojen
vertailutaulukko
Tarvikeluettelon sivulta T6.16c.

TRAKTORI- MALLI	TUULETTIMEN HIHNA	TUULETTIMEN SIIVET	JÄÄHDYTTIMEN KORKKI	JÄÄHDYTTIMEN YLÄVESI- LETKU	JÄÄHDYTTIMEN ALAVESI- LETKU
450, 640	AVX10-1175 4796327		T3360 4999682	T3362 4950088	T4013 596152
750, 850	AVX13-1325 44010698		T3360 4999682		
1000	T3356 x 2 4796327	T3374 4705372	T3360 4999682		T3365 597054
1300	AVX13-1325 x 2 44010698		T3360 4999682		
580, 680, 780	AVX10-1175 4796327		T3360 4999682	T3367 4997263	T4013 596152
880 4-syl.	AVX10-1300 4712148		T3360 4999682	T3368 4997336	
880 5-syl., 980	T3356 x 2 4796327	T3374 4705372	T3360 4999682	T3367 4997263	T4013 596152
1180	AVX10-1175 x 2 4796327	T3374 4705372	T3360 4999682	T3370 5107001	T4013 596152
1380	T3356 x 2 4796327		T3360 4999682	T3370 5107001 T3371 5121678	T4013 596152
1580, 1880	AVX10-1350 x 2 4796442		T3361 5129231	T3372 5106829	
55-90, 60-90, 70-90, 80-90	AVX10-1175 4796327		T3360 4999682	T3367 4997263	T4013 596152
90-90	AVX10-1175 x 2 4796327	T3374 4705372	T3360 4999682	T3367 4997263	T4013 596152
100-90	AVX10-1175 x 2 4796327	T3374 4705372	T3360 4999682	T3367 4997263	T4013 596152
115-90	AVX10-1175 x 2 4796327	T3374 4705372	T3361 5129231	T3371 5121678	T4013 596152
130-90, 140-90	AVX10-1175 x 2 4796327		T3361 5129231	T3371 5121678	T4013 596152
160-90	AVX10-1350 x 2 4796442		T3361 5129231	T3372 5106829	
180-90	AVX10-1350 x 2 4796442		T3361 5129231	T3372 5106829	

26.09.2011

Traktoreihin, joissa sylinterinkannessa numero 1



T3488

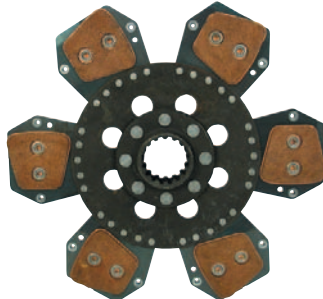

LUK331009210



LUK328009116



L6014-2RS



L6303-2RS

TRAKTORI-MALLI		KYTKIN-ASETELMA sis. ajolevyn	AJO-KYTKIN-LEVY	VOIMAN-ULOS-OTON LEVY	AJO-KYTKIMEN PAINE-LEVY	AJO-PAINE-LAAKERI	V.O.-PAINE-LAAKERI	SILMÄ-LAAKERI
312, 315, 411, 415	9"		T3737 4968740					
450, 480	10"		T3721 4968734					
550, 600, 640, 580, 680, 780	11"	(k)	T3022 (l) 5150650, 4999812 orgaani	LUK328009116 5160411		T3015 5122028	L6014-2RS 24905360	L6303-2RS 28043280
880 4-syl.	11"	(k)				T3015 5122028	L6014-2RS 24905360	L6303-2RS 28043280
55-90, 60-90 65-90, 70-90	11"	T3487(c) 805656 orgaani	T3022 (l) 5150650, 4999812 T3495 (m) 5145708	LUK328009116 (h) 5160411 LUK328018616 5154703	T3505	LUK500045900 5122028	L6014-2RS 24905360	L6303-2RS 28043280
70-90, 80-90 85-90	11"	T3488(c) 5150646 keraaminen	T3496 5150647	LUK328009116 (h) 5160411 LUK328018616 5154703	T3505	LUK500045900 5122028	L6014-2RS 24905360	L6303-2RS 28043280
850, 1000	12"		T3494 5160410					L6304-2RS(f) 410001710 L6204-2RS(g) 5120853
880 4-syl.	12"	(k)					L6014-2RS 24905360	L6304-2RS 410001710
880 5-syl., 980, 90-90, 100-90, 110-90	12"	(k)	T3492 5150922 keraaminen tai T3059A 5112856 orgaani				L6014-2RS 24905360	L6204-2RS 5120853
90-90 100-90 110-90	12"	T3665 (e) 5144020		LUK331013216 5154514		LUK500045900 5122028	L6015-2RS 5112084	L6204-2RS 5120853
1180 115-90	12"	(k)		LUK331013016 5154551		LUK500005910 5120853	LUK500005810 44016827	L6204-2RS 5120853

b - 2/80→ täydellinen

c - asennettaessa uusi **T3487** tai **T3488** asetus, käytettävä ehdottomasti **LUK328018616** (7,6 mm) V.O.-levyä
Vaihtokelpoisia seuraavalla sivulla esiintyvien LUK-kytkimien kanssa (**LUK228007714** ja **LUK228007710**)

d - ajokäpäläsarja

e - asennettaessa uusi **T3665** asetus, käytettävä ehdottomasti **LUK331013216** (7,6 mm) V.O.-levyä
Vaihtokelpoinen seuraavalla sivulla olevan **LUK231004911** kanssa

f - 850

g - 1000

h - **LUK328009116** vahvuus 8,6 mm, **LUK328018616** vahvuus 7,6 mm, **LUK331013216** vahvuus 7,6 mm

k - katso sivu C1.20

l - kiinteä

m - jousitettu

26.09.2011

Traktoreihin, joissa sylinterinkannassa nro 2 tai 3



LUK228007714



T3022



T3020



LUK500005910



LUK500039300



L6303-2RS

TRAKTORI-MALLI	TÄYD. KYTKIN-ASETELMA sis. ajo- kytkinlevy	AJO-KYTKIN-LEVY	VOIMAN-ULOSOTON KYTKIN-LEVY	AJO-KYTKIMEN KÄPÄLÄ-SARJA (c)	AJO-KYTKIMEN PAINE-LAAKERI	V.O.-KYTKIMEN PAINE-LAAKERI	SILMÄ-LAAKERI
(k): 550, 600, 640, 580, 680, 780	LUK228007714(a,d,1) 5106755 LUK228007710(b,d,1) 5145717	T3022 (a) 5150650 LUK328018510 (b) 5145718	LUK328009116 (f) 5160411 LUK328018616	T3020 9962518	LUK500045900	L6014-2RS	L6303-2RS
55-90, 60-90, 70-90, 80-90, 65-90, 85-90	LUK228007714(a,d,1) 5106755 LUK228007710(b,d,1) 5145717	T3022 (a) 5150650 LUK328018510 (b) 5145718	LUK328009116 (f) 5160411 LUK328018616	T3020 9962518	LUK500045900	L6014-2RS	L6303-2RS
650, 750 12"		T3474 (i) 9004183			LUK500045900	L6014-2RS	L6304-2RS
850, 880 4-syl.11"	LUK228003110(1) 5107183	LUK328007410 5102262	LUK328009216 5160410	T3020 9962518	LUK500045900	L6014-2RS	L6304-2RS
880 4-syl. 880 5-syl., 980, 90-90, 100-90, 110-90 90-95 12" 1000 13"	LUK231004911(e,1,p) 5154514 LUK231004919 (q) 5163936	LUK331013119 5163937 (7-lap. jousi) T3059A (a)	LUK331013216 5156514		LUK500045900	L6015-2RS 5112084	L6304-2RS (880-4) L6204-2RS
1180, 115-90 12"	LUK231005010 (1) 5144661				LUK500005910 5120853	LUK500005810 44016827	L6204-2RS
1580, 1880, 160-90, 180-90 12"	LUK631026109(1, 2) 5140361				LUK500005910 5120853		
L60	LUK628191009 (m, 1)						
L65	LUK231008910 (1) 5167933	LUK330005110 5167928			LUK500045900	LUK500039300	LUK410002500
L75, L85 TL80, TL90	LUK231008810 (1)	LUK331021910 5167936			LUK500045900	LUK500039300 5167183	LUK410002500 28043280

- a - orgaani
b - keraaminen
c - sarja yhteen kytkimeen
d - asennettaessa uusi **LUK228007714** tai **LUK228007710** asetelma, käytettävä ehdottomasti **LUK328018616** (7,6mm) V.O.-levyä. Vaihtokelpoisia edellisellä sivulla esiintyvien **LUK328009216**, **T3487** ja **T3488** kytkimien kanssa.
e - asennettaessa uusi **LUK231004911** asetelma, käytettävä ehdottomasti **LUK331013216** (7,6mm) V.O.-levyä. Vaihtokelpoinen edellisellä sivulla olevan Valeo **T3665** kanssa.
f - vahvuus **LUK328009116** = 8,6 mm, **LUK328018616** = 7,6 mm

- g - vahvuus **LUK331013216** = 7,6 mm
h - booriluku 11, halkaisija 32mm
i - booriluku 18, halkaisija 50mm
k - näissä malleissa esiintyy kahta eri kytkinakselimallia. Tarkista sopivuus ennen asennusta!
m - sis. asetelman ja ajolevyn
p - sisältää ajolevyn C-6
q - sisältää ajolevyn C-7
1 - ajolevy
2 - VO-levy

25.07.2008



TRAKTORI-MALLI		ASETELMA sis. ajo- kytkinlevyn	KYTKINLEVY AJO vaiht. puoleinen	V.O. vauhtip. puoleinen	TÄYD. KYTKIN- PAKETTI sis. asetelman, ajo- ja v.o.- kytkinlevyt ja painelaakerin (e)	PAINE- LAAKERI TÄYD.	SILMÄ- LAAKERI
550, 600, 640, 580, 680, 780	280 mm	M600 5177193 (T3480) (f) 5150650	D537C (c) 5150653 T3022 (d) 5150650	LUK328018616 5152710	K200E (g) 1930987	R242 5177194	L6303-2RS 28043280
850, 1000	310 mm	(T3485) (f) 5177203	T3494 44015757		K204E (h) 1930990	R246 5177204	L6304-2RS (a) 410001710 L6204-2RS (b) 5120853
880, 880/5, 980, 90-90, 100-90, 110-90	310 mm	M602 5177196 (T3483) (f)	T3492 5150922	LUK331013216 5152736	K202E (h) 1930988		L6204-2RS 5120853
1180, 115-90	310 mm	M603 5177199 (T3484) (f)	D538C 5151000	LUK331013016 5151001		R245 1930989	L6204-2RS 5120853

a - 850

b - 1000

c - keraaminen

d - orgaani

e - paketti sisältää asetelman, kytkinlevyt ja täydellisen painelaakerin

f - vanha tilausnumero

g - asennuksessa tarvitaan uudet pultit 6 kpl, til.no **PKH10090125**

h - asennuksessa tarvitaan uudet pultit 6 kpl, til.no **PKH10100125**

Korvattaessa vanhanmallinen kytkin samalla on vaihdettava uusi täydellinen painelaakeri sekä voimanulosoton kytkinlevy, tällöin suosittelemme täydellistä kytkinpakettia.

FERODO vanha malli 3-käpälää ja tähtijousi

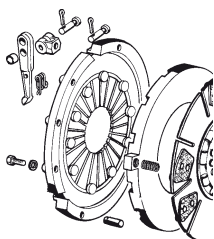

VALEO uusi malli 6-käpälää

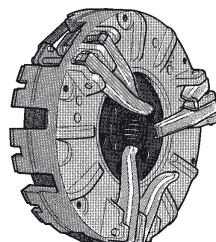

KESKIÖRASVA

LUK414001410

- erityisesti kytkinkeskiöihin
ja -akseleihin



C1.20

Alkuperäisnumerot ovat ainoastaan vertailua varten, eivät ole tärkeitä, että tuotteet ovat alkuperäisiä.
Taulukoissa esiintyvät kuvat ovat viitteellisiä.

26.09.2011

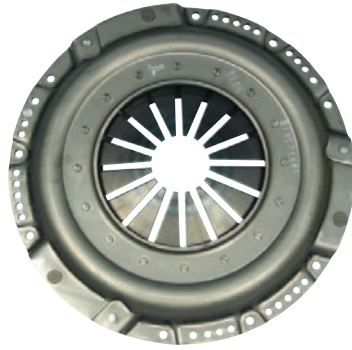

LUK135021510

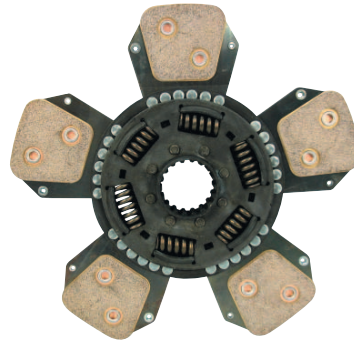

LUK333007211

TRAKTORIMALLI		KYTKINASETELMA	KYTKINLEVY	PAINELAAKERI
1180, 1380, 1580, 1880	14"	LUK135020510 (3) 5123061	LUK335012910 5150080 T3472 5118453	T3465 5121414
115-90, 130-90, 140-90	14"	LUK135020510 (3) 5123061	LUK335012910 5150080 T3472 5118453	T3465 5121414
Winner F100, F110, F115, F120 New Holland M100, M115	330 mm	LUK133021410 (3) 5154418	LUK333007211 5165650	T3684 5149611
Winner F130, F140 New Holland M135	350 mm	LUK135021510 (3) 88203039	LUK335012910 5150080	T3684 5149611
L95 New Holland M135, TL90	310 mm	LUK131024910 (3) 5167939, 5189823	LUK331021910 5167939	

3 - ei levyä

PAINEHOLKIN JOUSI

FT44011615

44011615

- 100-90, 110-90, 115-90, 130-90, 140-90, 160-90, 180-90, 55-90, 60-90, 65-90, 70-90, 80-90, 85-90, 90-90,
L60, L65, L75, L85, L95, TL60, TL65, TL70, TL80, TL90, TL100

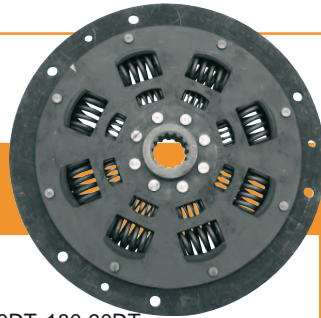

VAUHTIPYÖRÄN NAPA

LUK370001110

5153359

- 130-90DT, 140-90DT, 160-90DT, 180-90DT
- Power Shift -vaihteisto

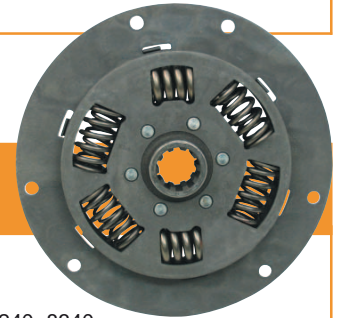

VAUHTIPYÖRÄN NAPA

LUK370000910

82008857

- 5640, 6640, 7740, 7840, 8240, 8340,
TS90, TS100, TS110 TS115
- Power Shift -vaihteisto



VAUHTIPYÖRÄN NAPA

LUK370001010

5187845

- 8160, 8260, 8360, 8560, M100, M115, M135, M160,
TM115, TM125, TM135, TM150, TM165
- Power Shift -vaihteisto



VAUHTIPYÖRÄN NAPA

LUK370001710

5187958

- TL70, TL80, TL90, TL100
- Power Shift -vaihteisto

C1.21

C1.22

Alkuperäisnumerot ovat ainoastaan vertailua varten, eivätkä tarkoita, että tuotteet ovat alkuperäisiä.
Taulukoissa esiintyvät kuvat ovat viitteellisiä.

25.07.2008

450
480
500
550
580
600
640
680
780

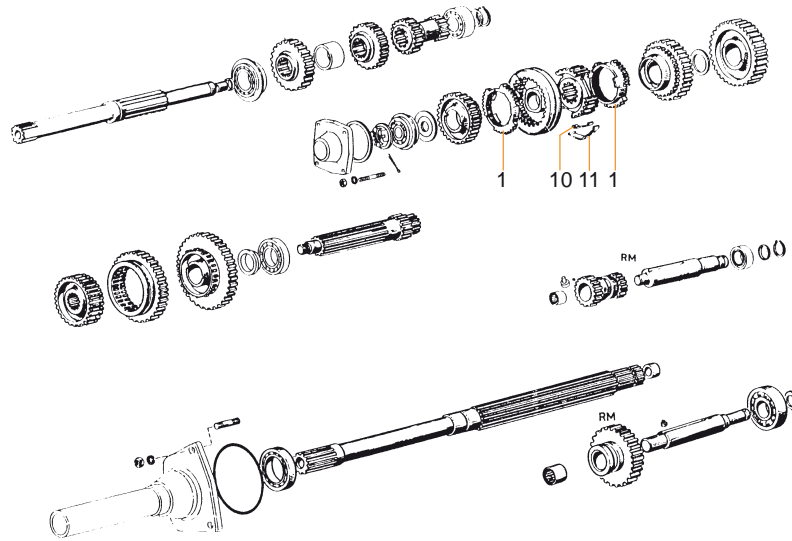

450
480
580
640
680
780
880
980
1180
1380
1580

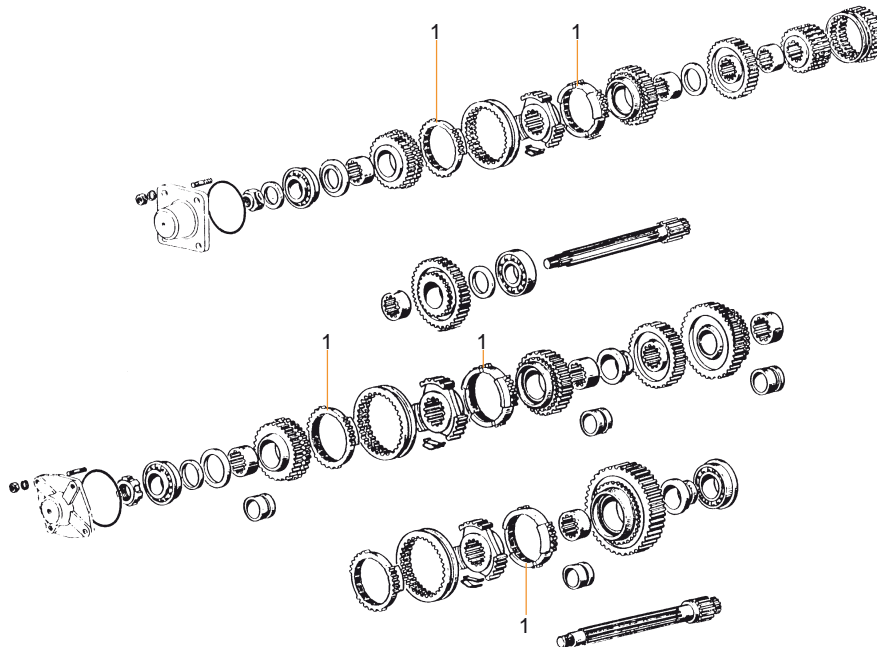

OSA	315 415	450 640	480 600	500 550	580 680	780	880	980 1580	1180 1380
1. Synkrokartio	T3007 5118187	T3007 5118187	T3007 5118187	T3007 5118187	T3007 5118187	T3007 5118187	T3007 5118187	T3007 5118187	T3007 5118187
10. Kytkin pala	T3011 4568626	T3011 4568626	T3011 4568626			T3011 4568626	T3011 4568626		
11. Kytkin jousi	T3012 4572860	T3012 4572860	T3012 4572860			T3012 4572860	T3012 4572860		

KYTKINAKSELIN JA VAIHTEISTON STEFATIIVISTEET	780 580 680	600 640	880 4-syl. 880 5-syl. 980, 90-90, 100-90	55-90 60-90 70-90 80-90	115-90 130-90	650	1180, 1380, 1580, 1880, 140-90 160-90 180-90
--	-------------------	------------	---	----------------------------------	------------------	-----	--

Kytkinakselin tiiviste	OAS456210 40000270 BIRD	OAS456510 40000370	OAS50689 5106069	OAS458510 5123299	OAS557010 5112307	OAS557510 44014376	OAS557010 5112307
Vaihdelaatikon takapään tiiviste	OAS25357 5105887		OAS28387 5106073		OAS32427 5112294		

08.05.2009

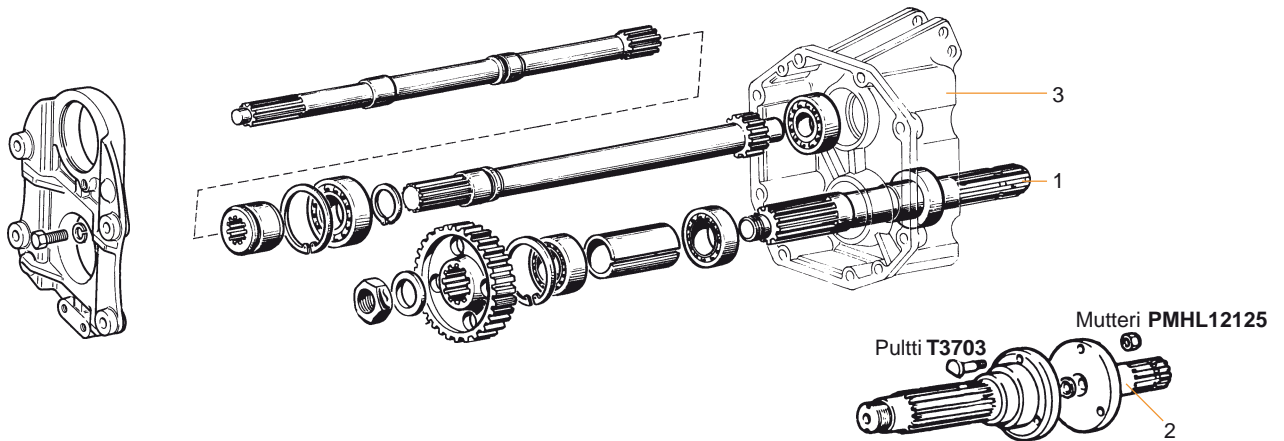

TRAKTORI-MALLI	1. ULOSOTTO-AKSELI 1-nop.	2. VOIMAN ULOSOTTOAKSELI 2-nopeuksisella laipalla		3. TAKAKANSI 2-nop.
		540 1/min 1 3/8 6Z	540 1/min 1 3/4 6Z	
750	T3074 44017106	T3074 44017106	T3075 5158578	
1000		T3074 44017106	T3075 5158578	
850, 1000 Super		T3074 44017106	T3075 5158578	
1300, 1300 Super		T3074 44017106	T3075 5158578	
580, 680, 780	T3030 4998230	T3074 44017106	T3075 5158578	T3612 5143642
880 4-syl., 880 5-syl.		T3074 44017106	T3075 5158578	T3612 5143642
980		T3074 44017106	T3075 5158578	T3612 5143642
1180, 1380, 1580, 1880		T3074 44017106	T3075 5158578	
60-90, 70-90, 80-90		T3074 44017106	T3075 5158578	
110-90, 90-90, 100-90		T3074 44017106	T3075 5158578	T3612 5143642
115-90, 130-90, 140-90, 160-90, 180-90		T3074 44017106	T3075 5158578	
F100, F110, F115, F120, L60, L65, L75, L85, L95, M100, M115, M135, M160, TL65, TL70, TL80, TL90, TM110, TM120, TM130, TM140			T3075 5158578	

SIIRTORATAS

FT4984103

4984103
- 880-110-90
- ajovoimanotto

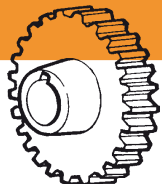

V.O.-RATAS

FT4995695

4995695
- 880-110-90
- murikalle





T3096



T3528



T3529



OAS508010

TRAKTORI-MALLI	HYDRAULINEN VOIMANOTON-KYTKIN	KYTKIMEN LEVYSARJA	KYTKIMEN HYDRAULI-PUMPPU	VOIMAN ULOSOTON TIIVISTE
1180	T3096 5107939	T3528 9968954	T3529 5135305	
1380	T3096 5107939	T3528 9968954	T3529 5135305	
1580	T3096 5107939	T3528 9968954	T3529 5135305	
1880	T3096 5107939	T3528 9968954	T3529 5135305	
115-90	T3096 5107939	T3528 9968954	T3529 5135305	
130-90	T3096 5107939	T3528 9968954	T3529 5135305	
140-90	T3096 5107939	T3528 9968954	T3529 5135305	
160-90	T3096 5107939	T3528 9968954	T3529 5135305	
180-90	T3096 5107939	T3528 9968954	T3529 5135305	
680, 780, 880 4-syl., 880 5-syl., 90-90 yksinopeuksinen				OAS558510 5105899
580, 680, 780, 880 4-syl., 880 5-syl., 980, 80-90, 100-90, 115-90, 130-90, kaksinopeuksinen				OAS689010 515891
60-90, 70-90, 80-90, 640 yksinopeuksinen				OAS508010 5111518
55-90, 60-90, 70-90 kaksinopeuksinen				OAS558010 5119203
1180, 1380, 1580, 1880, 140-90, 160-90, 180-90 kaksinopeuksinen				OAS689010 5112290

06.10.2006

**TÄYDELLISET
TASAUSPYÖRÄSTÖT**

T3591

T3591

5117236

- sopii: 580, 680 uudempi malli, 780,
70-90, 80-90, L75, L85, L95, TL80, TL90

T3335

5117247

- sopii: 880 4-syl., 880 5-syl., 980, 90-90, 100-90, 110-90

26.09.2011



FT5131916

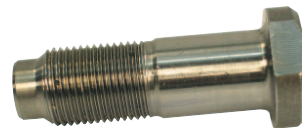

T3550



T3553

TRAKTORI-MALLI	NAPA-AKSELI	NAPA-AKSELIN TIIVISTE	TAKA-PYÖRÄN PULTTI	TAKA-PYÖRÄN MUTTERI
312, 315, 411, 415, 450, 500, 550, 600, 640, 650, 750		OAS50689 7106795	T3549	
850, 1000, 1000 Super			T3550 44011089	T3553 (e) 12164211
580		FT5123205 5123205	T3550 44011089	T3553 (e) 12164211
680	T3034 5168626	FT5123205 5123205	T3550 44011089	T3553 (e) 12164211
780	T3034 5168626	FT5123205 5123205	T3550 44011089	T3553 (e) 12164211
880-4		FT5123253 5123253	T3550 44011089	T3553 (e) 12164211
880-5		FT5123253 5123253	T3550 44011089	T3553 (e) 12164211
980	T3534 5123257	FT5123259 5123259	T3550 44011089	T3553 (e) 12164211
1180, 1380, 1580	T3535 (a) 5135352		T3552 5102745	T3553 (e) 12164211
55-90, 60-90, 65-90	T3536 5131917	FT5131916 5131916	T3550 44011089	T3553 (e) 12164211
70-90, 80-90	T3034 5168626	FT5123205 5123205	T3550 44011089	T3553 (e) 12164211
90-90		FT5123253 5123253	T3550 44011089	T3553 (e) 12164211
100-90, 110-90	T3534 5123257	FT5123259 5123259	T3550 44011089	T3553 (e) 12164211
115-90			T3552 5102745	T3553 (e) 12164211
130-90, 140-90, 160-90	T3535 (a) 5135352	FT5126465 5126465	T3552 5102745	T3553 (e) 12164211

a - osittain tarkista mitat vanhasta akselistasta

	sisemmän laakerin sisämitta	ulomman laakerin sisämitta	stefan sisämitta
	T3535	80	90
			130 mm

e - aluslevy mutterille T3554

PAINOVANTEEN MUTTERI

FT5100941

5100941

- painovannekeskiöllisiin Fiat-traktoreihin



26.09.2011

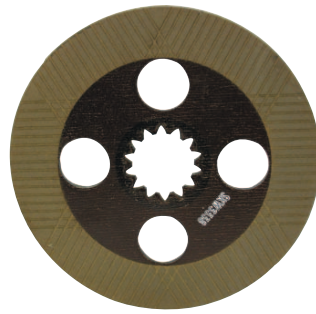

T3421



T3071



T3070



T3743

TRAKTORI-MALLI	JARRU-LEVY	KÄSIJARRUPALA 1-PUOL.	KÄSIJARRUPALA 2-PUOL.	MÄNNÄN O-RENKAAT
640	T3178 (a) 5107958			
580, 680, 780	T3423 (c) 5112630	T3071 5158120	T3070 5158123	T3745 (d) 5105536 T3744 (e) 5105534
880 4-syl., 880 5-syl., 980	T3423 (c) 5112630	T3071 5158120	T3070 5158123	T3742 (d) 5169562 T3743 (e) 5169561
1180, 1380, 1580, 1880		T3071 5158120	T3070 5158123	
55-90, 60-90, 70-90, 80-90	T3421 4997208 5184313			T3745 (d) 5105536 T3744 (e) 5105534
90-90, 100-90	T3423 5112630	T3071 5158120	T3070 5158123	T3742 (d) 5169562 T3743 (e) 5169561
115-90, 130-90, 140-90, 160-90, 180-90		T3071 5158120	T3070 5158123	
570, 580, 60-93, 60-94, 65-90, 65-93, 65-94, 670, 680, 72-93, 72-94, 780, 82-93, 82-94, 85-90, 88-93, 88-94, L60, L65, L75, L85, L95, TL60, TL 65, TL70, TL80, TL85, TL90, TL100	T3421 4997208 5184313			

a - jarrupanta

d - iso

e - pieni



JARRUNASTAVENTTIILI JA JOUSI

- 80, 90 ja 94-sarjat

T3746
4997674

T3747
4999488

26.09.2011



SÄÄTÖKAMPI

T3655

4999165
- Fiat 640
(kuvassa ylempi)

T3739

5125920
- 70-90, 80-90
- säätöalue 640-760 mm
- 24 mm vetovarrelle

RAJOITTIMEN KORVAKE

T0422

5127401
- 4-syl. 80, -90, -94-sarjat
- L = 1150 mm

T0408

5127015
- 6-syl. 80, -90-sarjat
- 110-90 saakka
- L = 1550

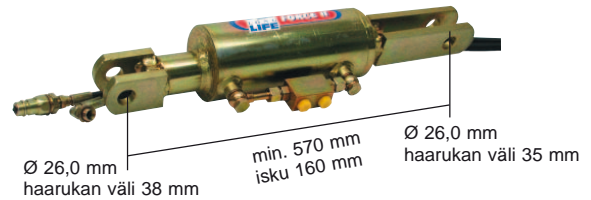
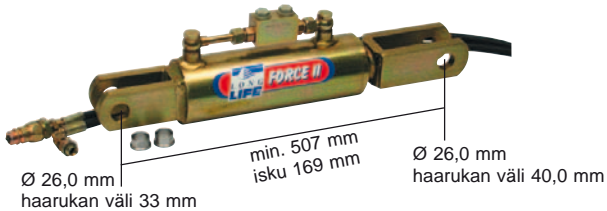

HYDRAULINEN SÄÄTÖKAMPI

T1720

- 60-90-110-90
- mäntä 80 mm
- varsi 40 mm
- sovitusholkki 25,9/22,2 mm 2 kpl

HYDRAULINEN SÄÄTÖKAMPI

T1722

- New Holland M135
- mäntä 100 mm
- varsi 50 mm



NOSTOVARSI

T3969

5119733
- 70-90 (1/84-12/92), 80-90 (1/84-12/92),
85-90 (1/89-12/92),

26.09.2011

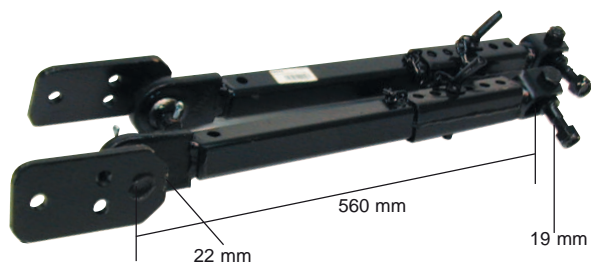

SIVURAJOITINPARI

T0171

- Fiat 415, 600, 640
- sisäosa 30x30 mm
- sokkatappi 12 mm

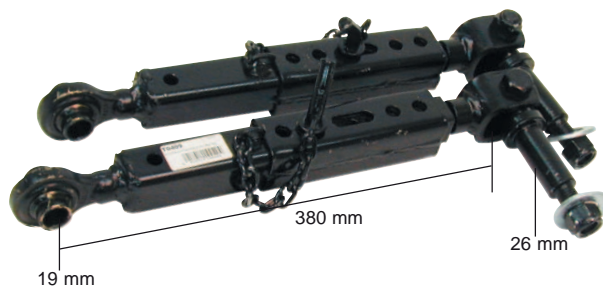

SIVURAJOITINPARI

T0409

- 5123273
- Fiat 580, 680, 780
- sisäosa 30x30 mm, sokkatappi 12 mm

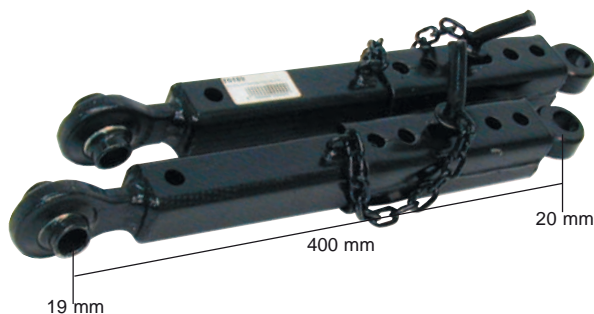

SIVURAJOITINPARI

T0189

- 5123273
- Fiat 55-90-110-90
- sisäosa 30x30 mm, sokkatappi 12 mm

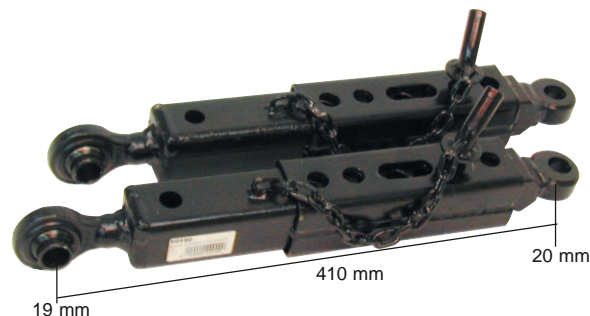

SIVURAJOITINPARI

T0190

- 5109518
- Fiat Winner-sarja
- sisäosa 40x40 mm, sokkatappi 16 mm



SIVURAJOITINPARI

F1018

- 5170360
- F115, F115DT, F140, F140DT

06.10.2006

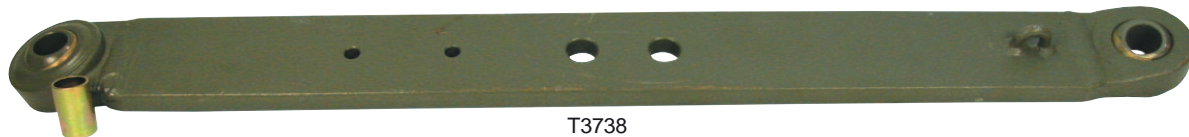

T3738



T3083



T3048



T3748



T3750



T3677

TRAKTORI-MALLI	POIKIT-TAIS-AKSELI	POIKIT-TAIS-AKSELIN PUSLA	POIKIT-TAIS-AKSELIN TIIVISTE	VETO-VARREN POIKKI-KARTTU	VETO-KARTUN TIIVISTE
312, 315, 411, 415, 450, 500, 550, 600, 640	T3048 4955425				
580, 680, 780, 880 4-syl.			T3750 5159078		
580, 680, 780, 880 4-syl., 880 5-syl., 980 uudempi			T3750 5159078	T3548 5111458	
55-90, 60-90, 70-90, 80-90, 65-90		T3748 (a) 5186406 T3749 (b) 5186405	T3750 5159078	T3083 5116243	T3677 5121123
1180, 1380, 1580, 1880, 115-90, 130-90, 140-90, 160-90, 180-90		T3748 (a) 5186406 T3749 (b) 5186405	T3750 5159078		
90-90, 100-90		T3748 (a) 5186406 T3749 (b) 5186405	T3750 5159078	T3548 5111458	

a - oikea 2 kpl/traktori

b - vasen 2 kpl/traktori

RAJOITTAJAN TAPPI

T0616

5103862
- vahvuus 16 mm
- pituus 62 mm

T0619

5105520
- vahvuus 19 mm
- pituus 73 mm



NOSTOSYLINTERIN TIIVISTEET



T3731



T3732



T3735



T3736

TRAKTORI-MALLI	TUKI-RENGAS	O-RENGAS ETU	O-RENGAS TAKA	TUKIRENGAS TAKA
640, 550, 580, 680, 780, 880, 980	T3729 4999412	T3732 14472880	T3735 14472380	T3736 5106297
55-90, 60-90, 65-90		T3733 1446568		
70-90, 80-90, 85-90, 90-90, 100-90, 110-90	T3731 5125941	T3734 14465981		

C1.31

21.09.2009



T3452



T3112



T3446, T3448, T3448XL



T3713

TRAKTORI-MALLI	HYDRAULIPUMPPU		OHJAUS-TEHOSTIMEN PUMPPU	KÄYTTÖ-RATAS	KYTKENTÄ-HOLKKI	HELA
450	T3452 8273385		T3111 50130133	T3049 4673811	T3089 5118570	T3088 5118569
600, 640	T3112 5129478	T3446 (a) 5129483	T3111 50130133	T3049 4673811	T3089 5118570	T3088 5118569
750	T3112 5129478		T3111 50130133			
850, 1000	T3446 5129483		T3111 50130133	T3443 4747597	T3089 5118570	T3088 5118569
1000, 1300			T3111 50130133	T3443 4747597	T3089 5118570	T3088 5118569
580, 680, 780	T3112 5129478	T3446 (a) 5129483	T3111 50130133	T3049 4673811	T3089 5118570	T3088 5118569
880 4-syl.	T3112 5129478	T3446 (a) 5129483	T3111 50130133		T3089 5118570	T3088 5118569
880 5-syl.	T3112 5129478	T3446 (a) 5129483	T3452 8273385 T3453 (b) 98307212	T3443 4747597	T3089 5118570	T3088 5118569
980	T3112 5129478	T3446 (a) 5129483	T3453 (b) 98307212	T3443 4747597	T3089 5118570	T3088 5118569
1180	T3446 5129483		T3453 (b) 98307212	T3443 4747597	T3089 5118570	T3088 5118569
1380	T3448 5129488		T3453 (b) 98307212	T3443 4747597	T3089 5118570	T3088 5118569
1580, 1880	T3448 5129488		T3453 (b) 98307212		T3089 5118570	T3088 5118569
55-90, 60-90, 70-90, 80-90	T3446 5129483	T3448 (a) 5129488	T3454 (b) 5180269 tai T3455 (c, b) 5180273		T3089 5118570	T3088 5118569
90-90, 100-90, 110-90	T3448 5129488	T3448XL (a) 2TK22S	T3454 5180269 tai T3455 (c, b) 5180273		T3089 5118570	T3088 5118569
115-90, 130-90, 140-90	T3448 5129488	T3448XL (a) 2TK22S	T3455 (b) 5180273		T3089 5118570	T3088 5118569
160-90, 180-90	T3448 5129488	T3448XL (a) 2TK22S	T3455 (b) 5180273		T3089 5118570	T3088 5118569
F110, F120, F130, F140	T3713 (d) 5179726		T3714 (e) 5180275			
8160, 8260, 8360, L60, 65, 75, 85, 95, M100, 115, 135, 160, TL65, 70, 80, 90, 100, TM115, 120, 125, 130, 140	T3713 (d) 5179726					

a - suurempi malli

b - pumppu on varustettu paineventtiillä

c - uudemmissa Hi-Lo-malleissa **T3455** (C30XRP)

d - **T3713** C42

e - **T3714** A31XRP2

25.07.2008

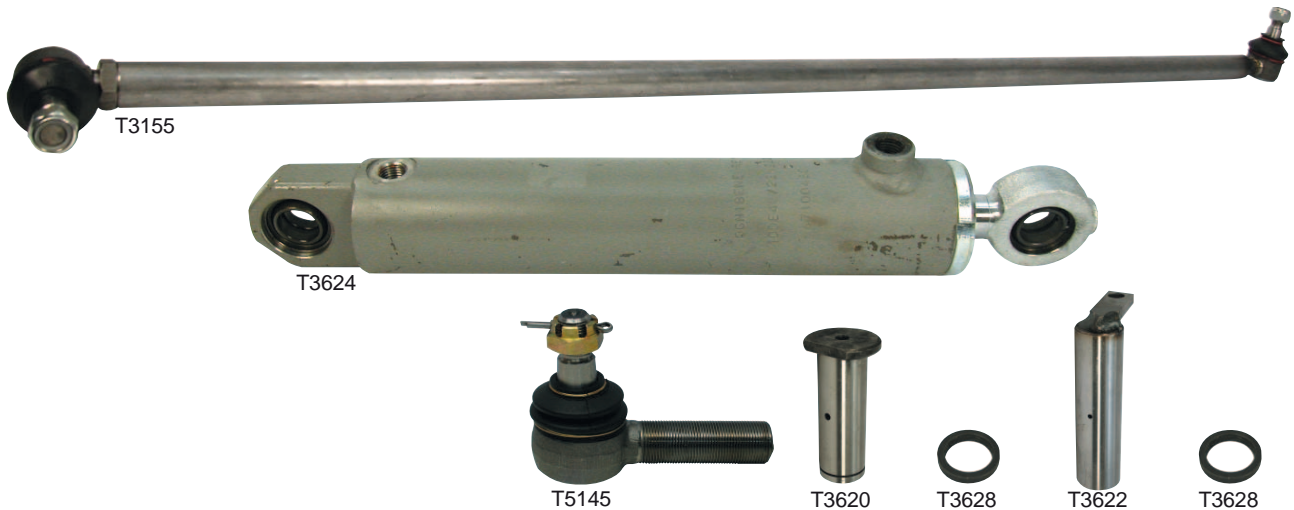

TRAKTORI-MALLI	TÄYDELLINEN RAIDE-TANKO	RAIDE-TANGON NIVEL (c)	OHJAUS-SYLINTERI	ULOMPI TAPPI	LEVY	SISEMPI TAPPI	LEVY
450, 500, 600, 640, 650, 750		T3154 802337					
850, 1000, 1300		T3559 802696					
580, 680, 780	T3561 (b) 5108800	T3154 802337	T3624 5110840	T3621 (e) 4987671	T3627 5100730	T3623 (e) 5142048	T3629 5100731
880 4-syl., 880 5-syl., 980		T3559 802696	T3624 5110840	T3621 (e) 4987671	T3627 5100730	T3623 (e) 5142048	T3629 5100731
1180, 1380, 1580, 1880		T5145 802690 T3559 (d) 802696		T3620 (f) 5111572	T3628 5111573	T3622 (f) 5111574	T3628 5111573
55-90, 60-90, 65-90	T3155 5104081	T3154 802337	T3624 5110840	T3621 (e) 4987671	T3627 5100730	T3623 (e) 5142048	T3629 5100731
70-90, 80-90		T5145 802690 T3154 (d) 802337	T3625 5137121	T3620 (f) 5111572	T3628 5111573	T3622 (f) 5111574	T3628 5111573
90-90, 100-90, 110-90		T5145 802690 T3154 (d) 802337	T3625 5137121	T3620 (f) 5111572 T3621 (d) 4987671	T3628 5111573 T3627 (d) 5100730	T3622 (f) 5111574 T3623 (d) 5142048	T3628 5111573 T3629 (d) 5100731
115-90, 130-90, 140-90, 160-90, 180-90		T5145 802690		T3620 (f) 5111572 T3621 (d) 4987671	T3628 5111573 T3627 (d) 5100730	T3622 (f) 5111574 T3623 (d) 5142048	T3628 5111573 T3629 (d) 5100731

a - pituus 1375 mm

b - pituus 1380 mm

c - **T3154** kier. 19,8 mm, kartio 18,2/19,5

T3559 kier. 24 mm, kartio 18,2/20,5

T5145 kier. 23,8 mm, kartio 20/22

d - jos etuakseli on alunperin varustettu kahdella ohjaussylinterillä

e - laakeri **GE20**, Ø 20 mm

f - laakeri **GE25**, Ø 25 mm

25.07.2008

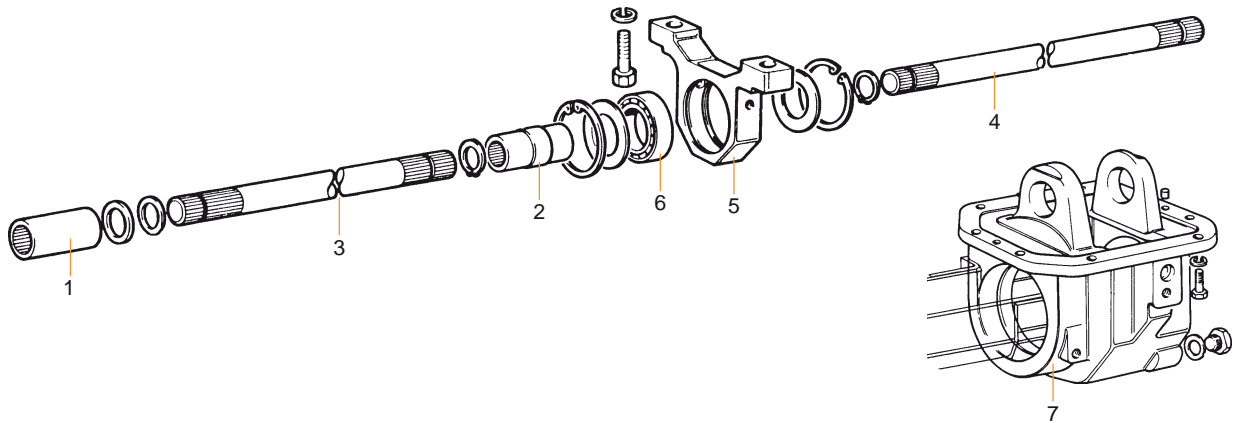

TRAKTORI-MALLI	1 KARD. HOLKKI ETU	2 KARD. HOLKKI KESKI	3 KARD.- AKSELI ETU	4 KARD.- AKSELI TAKA	5 KARD. KANNATIN	6 KARD. KANNAT- TIMEN LAAKERI	7 LÄHTÖ- KOTELO
580	T3120 5199243	T3118 4997312			T3068 4997310	L6008-2RS 24905120	
680, 780	T3120 5199243	T3118 4997312	T3119 (a) 5108753		T3068 4997310	L6008-2RS 24905120	
880 4-syl., 880 5-syl.	T3323 4994076	T3324 4994075			T3069 4994065	L6009-2RS 24905130	
980	T3323 4994076	T3324 4994075			T3069 4994065	L6009-2RS 24905130	
1180, 1380	T3323 4994076	T3324 4994075			T3069 4994065	L6009-2RS 24905130	
1580, 1880	T3323 4994076	T3324 4994075			T3069 4994065	L6009-2RS 24905130	
55-90, 60-90, 65-90	T3120 5199243	T3118 4997312		T3391 5121352	T3068 4997310	L6008-2RS 24905120	T3639 5169906
70-90, 80-90	T3120 5199243	T3118 4997312	T3392 5121364	T3391 5121352	T3068 4997310	L6008-2RS 24905120	T3639 5169906
90-90	T3323 4994076	T3324 4994075			T3069 4994065	L6009-2RS 24905130	
100-90, 110-90	T3323 4994076	T3324 4994075			T3069 4994065	L6009-2RS 24905130	
90-90, 100-90, 110-90 (nopea malli)	T3323A (14 ura) 5150124				T3069 4994065	L6009-2RS 24905130	
115-90, 130-90, 140-90	T3323 4994076	T3324 4994075			T3069 4994065	L6009-2RS 24905130	
160-90, 180-90	T3323 4994076	T3324 4994075			T3069 4994065	L6009-2RS 24905130	

a - osittain pituus 850 mm, (-79 eteenpäin)

25.07.2008



TRAKTORI- MALLI	PUSLA		OLKA- TAPPI	OLKA- TAPIN LAAKERI- STEFA	KÄÄNTÖKOTELO		NAPA- AKSELI
	ETU	TAKA	YLÄ/ALA		OIKEA	VASEN	ETU
580, 680 (a) 780 vanhempi malli	T3193 5101112	T3346 5129385	T3652 4997354	L32006 5109555 OAS50627 5122548			
580, 680, 780	T3193 5101112	T3346 5129385	T3189 5121116	LM86649-610 OA56708 5121471			T3586 5131122
880 4-syl., 880 5-syl., 980	T3193 5101112	T3346 5129385	T3189 5121116	LM86649-610 OA56708 5121471	T3439 4994186		
1180, 1380, 1580, 1880	T3193 5101112	T3346 5129385	T3188 5120531	L32208 5119660			
55-90, 60-90	T3193 5101112	T3346 5129385					
65-90	T3193 5101112	T3346 5129385					T3715 5126631
70-90, 80-90	T3193 5101112	T3346 5129385	T3189 5121116	LM86649-610 OA56708 5121471	T3597 5126939		T3586 5131122
90-90, 100- 90, 110-90	T3193 5101112	T3346 5129385	T3189 5121116	LM86649-610 OA56708 5121471	T3599 5127197	T3598 5127196	
115-90, 130-90, 140-90, 160-90	T3193 5101112	T3346 5129385	T3188 5120531	L32208 5119660			

a - vanhempi malli = olkatappi pienempi



ETUAKSELIN HYDRAULINEN TASAUSPYÖRÄSTÖN LUKKO

T3585

5142829

- 1380, 1580, 1880, 115-90, 130-90, 140-90, 160-90, 180-90

C1.35

Alkuperäisnumerot ovat ainoastaan vertailua varten, eivätkä tarkoituksena, että tuotteet ovat alkuperäisiä.
Taulukoissa esiintyvät kuvat ovat viitteellisiä.

25.07.2008



T3689



FT5133799

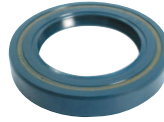

FT5136002



L32015

TRAKTORI-MALLI	ETUNAVAN ISO TIIVISTE	ULOMMAN VETO-AKSELIN TIIVISTE	SISEMMÄN VETO-AKSELIN TIIVISTE	NAVAN LAAKERI SISEMPI	NAVAN LAAKERI ULOMPI
580 vanha, 680 vanha, 780 vanha		FT5133799 5133799	FT5116701 5116701		
1300	FT5136003 5136003		FT5136002 5136002	L32015 24903480	L32016 24903490
640, 650	FT5107808 5107808		FT5105948 5105948		
580, 680, 780	FT5136004 5136004	FT5133799 5133799	FT5136002 5136002	L32014 24903470	L32014 24903470
880, 880-5, 980	FT5136003 5136003	FT5135990 5135990	FT5136002 5136002	L32015 24903480	L32016 24903490
1180, 1380, 1580, 1880	FT5107808 5107808		FT5105948 5105948	L32016 24903490	
55-90, 60-90	FT5135387 5135387	FT5116717 5116717	FT5116701 5116701		
65-90			FT5116701 5116701		
70-90, 80-90	FT5136004 5136004	FT5133799 5133799	FT5136002 5136002	L32014 24903470	L32014 24903470
90-90, 100-90	FT5136003 5136003	FT5135990 5135990	FT5136002 5136002	L32015 24903480	L32016 24903490
110-90	FT5137109 5137109	FT5133799 5133799			
115-90, 160-90, 180-90	FT5107808 5107808	FT5135990 5135990	FT5105948 5105948	L32016 24903490	
130-90, 140-90	FT5107808 5107808	FT5135990 5135990	FT5105948 5105948	L32016 5133737	L32018 5133737
F110	FT5137109 5137109				

HUOM! Tarkista aina mitat!

ETUMURIKAN TIIVISTE

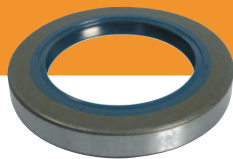

FT5111415

5111415

- 57 x 85 x 12

- sopii: 70-90, 80-90, 100-90, 110-90, 115-90, 130-90, 140-90, 160-90, 180-90, F120, F130, F140, M135, M160

ETUNAVAN TIIVISTE



FT5133736

5133736

- sisempi

- 190 x 220 x 21

- sopii: 115-90, 130-90, 140-90, 160-90, 180-90, 8360, 8430, 8560, 8630, 8830, M135, M160, TL100, TL80, TL90

05.02.2010

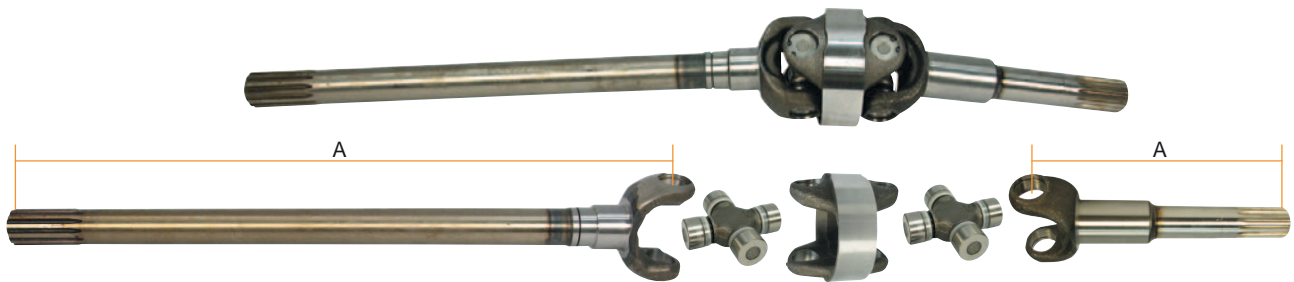

580, 680, 780 (osat sopivat, täyd. vetoakseli ei) 55-90, 60-90, 65-90			Mitta A	Poori- luku
T3031	9928667	Välipala		
CR277	4552009	Ristikko 27,00 x 74,60 mm		
CR048		Ristikko 27,00 x 74,60 mm rasvanipalla		
T3181	9956516	Etuvetoakseli sisempi	580 mm	10
T3386	9928665	Etuvetoakseli ulompi	94 mm	15

880, 980 70-90, 80-90, 90-90, 100-90, 110-90 F100, F110, F115, 84-94			Mitta A	Poori- luku
T3688	5114993	Vetoakseli täydellinen oikea		12/13
T3184	9930899	Välipala		
T3387	9962244	Ristikko 27,00 x 81,70 mm (alkup.) 9962244		
CR392(a)	9923550	Ristikko 27,00 x 81,70 mm		
T3085	9930900	Vetoakseli vasen	607 mm	12
T3086	9930902	Vetoakseli oikea	670 mm	12

580, 680, 780 70-90, 80-90, 90-90, 100-90, F100, F110, F115, 84-94			Mitta A	Poori- luku
T3689	5114991	Vetoakseli täydellinen vasen		12/14
T3690	5114989	Vetoakseli täydellinen oikea		12/14
T3184	9930899	Välipala		
T3387		Ristikko 27,00 x 81,70 mm (alkup.) 9962244		
CR392(a)	9923550	Ristikko 27,00 x 81,70 mm		
T3093	9957397	Etuvetoakseli vasen	531 mm	12
T3094	9957395	Etuvetoakseli oikea	595 mm	12
T3095	9957396	Etuvetoakseli ulompi	242 mm	14

8160, 8260, M100, M115, M160 F100, F115, 90-90, 100-90, 110-90			Mitta A	Poori- luku
T3184	9930899	Välipala		
T3387	9962244	Ristikko 27,00 x 81,70 mm (alkup.) 9962244		
CR392(a)	9923550	Ristikko 27,00 x 81,70 mm		
T3741	5164853	Vetoakseli täydellinen oikea		12/14

1180, 1380, 1580, 1880 115-90, 130-90, 140-90, 160-90, 180-90			Mitta A	Poori- luku
T3644	9959702	Välipala		
CR098	9959701	Ristikko 30,17x92,00 mm		

1180, 1380, 1580, 1880 115-90, 130-90, 140-90, 160-90, 180-90			Mitta A	Poori- luku
T3644	9959702	Välipala		
CR098	9959701	Ristikko 30,17x92,00 mm		
T3645	9959692	Etuvetoakseli oikea	696 mm	14

a - nivelessä ei rasvanippaa, kestää suuremman rasituksen

04.03.2011

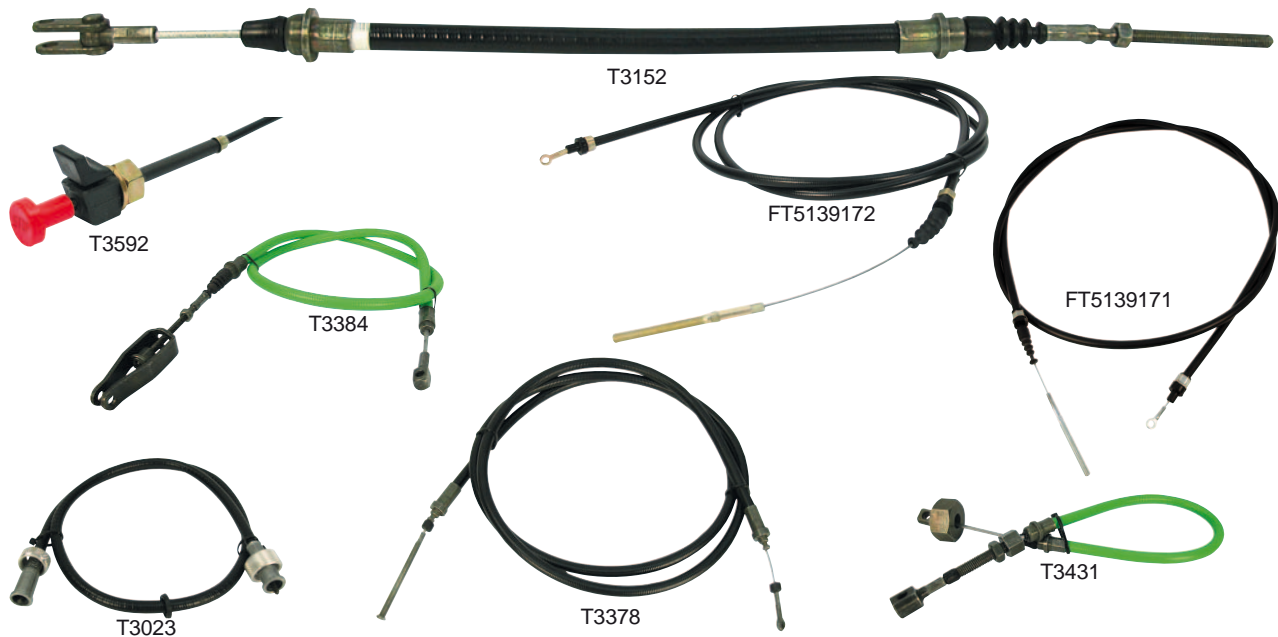

TRAKTORI-MALLI	STOP-VAIJERI	TUNTI-MITTARIN VAIJERI	KÄSI-KAASU-VAIJERI	AJO-KYTKIMEN VAIJERI	VOIMAN ULOSOTON KYTKIMEN VAIJERI	NOSTOLAITTEEN VAIJERI	KÄSI-JARRU-VAIJERI
640		T3023 4976720					
750, 850		T3325 4976739					
1000		T3331 4976770					
580		T3023 4976720	T3066 5149955	T3065 5115686	T3064 5101694	T3036 4999388	
680	T3592 5153380	T3023 4976720	T3066 5149955	T3065 5115686	T3064 5101694	T3036 4999388	
780	T3592 5153380	T3023 4976720	T3066 5149955	T3065 5115686	T3064 5101694	T3036 4999388	
880 4-syl.	T3592 5153380	T3325 4976739	T3066 5149955	T3152 5120399	T3126 5101695	T3036 4999388	
880 5-syl., 980	T3593 5153381	T3023 4976720	T3066 5149955	T3152 5120399	T3126 5101695	T3036 4999388	
1180	T3593 5153381		T3378 5149956				T343 (c) 5111687
1380	T3592 5153380		T3378 5149956				T3431 (c) 5111687
1580	T3593 5153381	T3329 5112653	T3378 5149956				T3431 (c) 5111687
1880		T3329 5112653	T3378 5149956				T3431 (c) 5111687
55-90, 60-90, 70-90, 80-90		T3023 4976720	T3378 5149956	T3152 5120399	T3384 5126567	FT5139172 (a) 5139172	T3430 (b) 5125736
90-90		T3023 4976720	T3378 5149956	T3152 5120399	T3385 5131252	FT5139172 (a) 5139172	T3431 (c) 5111687
100-90, 110-90		T3023 4976720	T3378 5149956	T3152 5120399	T3385 5131252	FT5139172 (a) 5139172	T3431 (c) 5111687
115-90, 130-90, 140-90	T3592 5153380	T3330 4976718	T3378 5149956			FT5139171 5139171	T3431 (c) 5111687
160-90	T3593 5153381	T3329 5112653	T3378 5149956			FT5139171 5139171	T3431 (c) 5111687
180-90		T3329 5112653	T3378 5149956			FT5139171 5139171	T3431 (c) 5111687
8430, 8630, 8830						FT5139171 5139171	

a - FT5139172 nostolaitteen "Clic Clac" -vaijeri

b - 680 mm pitkä

c - 650 mm pitkä

26.09.2011



TRAKTORI-MALLI	STARTTI BOSCH-TYYPPI	STARTTI MARELLI-TYYPPI	SOLENOIDI BOSCH	SOLENOIDI MARELLI	BENDIX-RATAS BOSCH	BENDIX-RATAS MARELLI
450, 500		ST0220 4682998		ST0170 9940366		
550, 600	SM2505 0001367028	ST0172 4807375	ST0171 20301070		ST1027	
640	SM2505 0001367028	ST0172 4807375	ST0171 20301070	ST0170 9940366	ST1027	ST0189 9986112
650, 750, 850, 1300		ST0214 4737758				
1000	SM2505 0001367028	ST0172 4807375	ST0171 20301070	ST0170 9940366	ST1027	ST0189 9986112
880-4-syl.		ST0214 4737758	ST0171 20301070	ST0170 9940366		ST0189 9986112
680, 780, 880-5, 980, 1180	SM2505 0001367028	ST0172 4807375	ST0171 20301070	ST0170 9940366	ST1027	ST0189 9986112
880-5, 980, 1180, 1380, 1580	SM2537 0001367029	ST0201 4807376	ST0171 20301070	ST0170 9940366		ST0189 9986112
1880	SM2537 0001367029	ST0201 4807376		ST0170 9940366		ST0189 9986112
580, 55-90, 60-90		ST0220 4682998	ST0171 20301070	ST0170 9940366		ST0189 9986112 ST0199 4808498
65-94, 70-90, 72-94, 80-90, 82-94, 65-90, 85-90, 88-94	SM2505 0001367028	ST0172 4807375		ST0170 9940366	ST1027	ST0189 9986112
90-90, 100-90, 115-90	SM2537 0001367029	ST0201 4807376		ST0170 9940366		ST0189 9986112
130-90, 140-90, 110-90 160-90, 180-90	SM2537 0001367029	ST0201 4807376		ST0170 9940366		ST0189 9986112
NEW HOLLAND M-sarja	ST0235 82005342					
L65, L75, L85, L95	SM2505 0001367028	ST0172 4807375		ST0170 9940366	ST1027	ST0189 9986112

26.09.2011

VAIHTOVIRTALATURIT

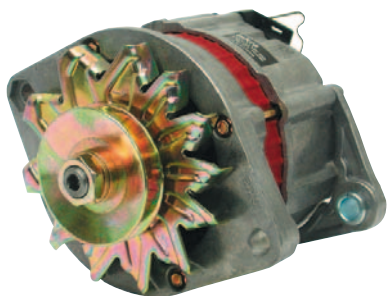

ST0169

4746400
 - 55 Ah
 - 640, 580-1580
 (55-90, 60-90 osittain)

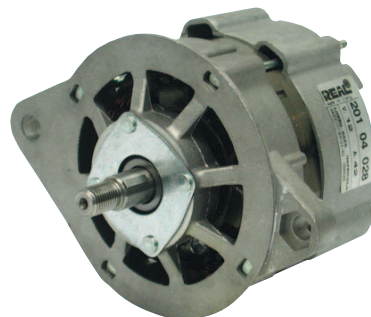

ST0198

4222697
 - 42 Ah
 - 650, 750, 850, 1000, 1300

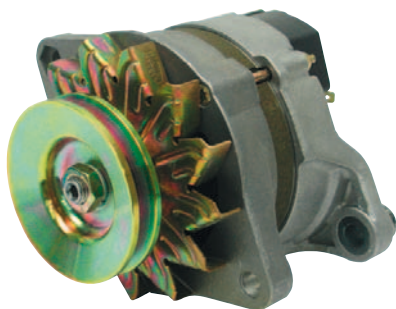

ST0199

4808498
 - 45 Ah
 - w-liittimellä
 - 65-90, 70-90, 80-90, 90-90, 82-94, 88-94
 (55-90, 60-90 osittain)

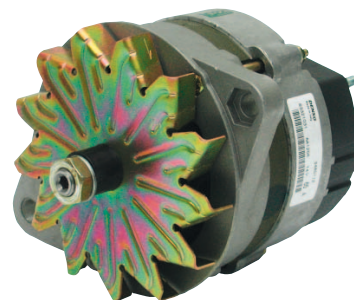

ST0200

4808517
 - 65 Ah
 - w-liittimellä
 - 90-90, 100-90, 115-90, 130-90, 140-90, 110-90,
 F100, F110, F120, F130, F140

STARTTIKEHÄ

T3968

4602203
 - 100-90, 110-90, 115-90, 130-90, 140-90, 160-90,
 180-90, 90-90



C1.40

26.09.2011



VILKKURELE

ST0260

5125586
- yleismalli



VALOKATKAISIN

T3582

4998107, 5125958
- 580, 680, 780, 880-4, 880-5, 980,
1180, 1380, 1580, 1880

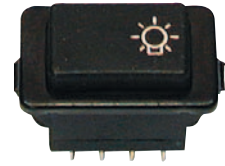

VALOKATKAISIN

T3705

5126126
- 55-90, 60-90, 65-90, 70-90, 80-90,
85-90, 90-90, 100-90, 115-90,
130-90, 140-90, 160-90, 180-90

HEHKUKATKAISIN

T3707

5176282
- 55-90, 60-90, 65-90,
70-90, 80-90, 85-90,
90-90, 100-90, 115-90,
130-90, 140-90, 160-90, 180-90



TYÖVALOKATKAISIN

T3706

9957649
- 55-90, 60-90, 65-90,
70-90, 80-90, 85-90,
90-90, 100-90, 115-90,
130-90, 140-90, 160-90, 180-90



JARRUVALON KATKAISIJA

F1011

4954118, 5086011, 5121786, 5152966
- 100-90, 110-90, 115-90, 130-90, 140-90, 160-90,
180-90, 60-90DT, 65-90DT, 65-94DT, 70-90DT,
72-94DT, 80-90DT, 82-94DT, 90-90DT, F100,
F100DT, F115DT, F120DT, F130DT, F140DT

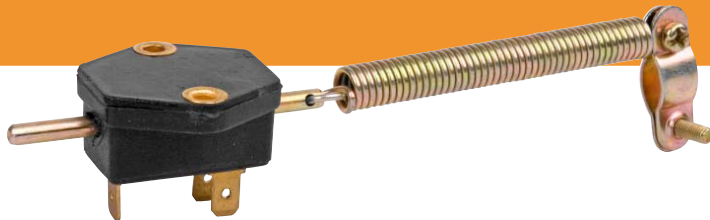

MONITOIMIKATKAISIN VASEN

T3967

5126127
- 115-90, 130-90, 140-90,
160-90, 180-90



MONITOIMIKATKAISIN OIKEA

T3698

5129345
- 55-90, 60-90, 65-90,
70-90, 80-90, 85-90,
90-90, 100-90, 110-90



26.09.2011

VIRTA- LUKKO

T3514

4158641
5118483
- 450, 500,
550, 600,
640, 650, 750, 850,
1000, 1300



VIRTA- LUKKO

T3190

4998108, 5112124,
5122727
- 580, 680, 780, 880, 980,
1180, 1380, 1580, 1880,
60-90, 65-90, 65-94,
70-56, 70-66, 70-90, 80-66, 80-90,
82-93, 82-94, 85-90, 88-94, 90-90,
100-90, 110-90, 115-90, 130-90,
140-90, 160-90, 180-90



VIRTA- LUKKO

T3755

5154401
- 23/950-30
- F100, F110, F115,
F120, F130, F140,
L60, L65, L75, L85, L95



PYSÄYTIN- SOLENOIDI

F1000

8190393
- 100-90, 110-90, 55-46, 55-56, 55-90, 60-46,
60-56, 60-90, 60-93, 60-94, 65-56, 65-90,
65-94, 70-56, 70-90, 72-93, 72-94, 80-90,
82-93, 90-90, L60, L65,
M100, M115, M135, M160



PYSÄYTIN- SOLENOIDI

T3769

9986316
- 100-90, 45-66, 50-66, 55-46, 55-56, 55-66,
55-88, 55-90, 60-46, 60-66, 60-88, 60-90,
60-93, 60-94, 65-46, 65-66, 65-88, 65-90,
65-93, 70-66, 70-88, 70-90, 80-66, 80-88,
80-90, 82-86, 85-90, F100, F110, F120



25.07.2008



ETUVALO

T3617

5137933

- pyöreä, täydellinen
- sopii 580-1880



ETUVALO

T3616

5138349

- suorakaide, täydellinen
- sopii 580-1880, 55-90 - 180-90



ETUÄÄRI-VALO OIKEA

F0658

5146291

- sopii: L60, 65, 75, 85, 95 M100, 115, 135, 160 TM115, 120, 125, 130, 135, 140, 150, 155, 165, 175, 190, TS90, 100, 110, 115

ETUÄÄRI-VALO VASEN

F0659

5146292

- sopii: L60, 65, 75, 85, 95 M100, 115, 135, 160 TM115, 120, 125, 130, 135, 140, 150, 155, 165, 175, 190, TS90, 100, 110, 115



TAKARAJAVALO VASEN

T3046

4997266

- pininfarina, cabina larga, 100-90, 110-90, 115-90, 1180, 1280, 130-90, 1380, 140-90, 1580, 160-90, 1880, 446, 45-66, 466, 50-66, 55-66, 55-90, 566, 580, 60-66, 60-90, 60-93, 60-94, 65-66, 65-90, 65-93, 65-94, 666, 680, 70-66, 70-90, 72-93, 72-94, 766, 780, 80-66, 80-90, 82-93, 82-94, 85-90, 880, 880-5, 88-93, 88-94, 90-90, 980
- varalasi T3044 (9929834)



TAKARAJAVALO OIKEA

T3047

4997267

- pininfarina, cabina larga, 100-90, 110-90, 115-90, 1180, 1280, 130-90, 1380, 140-90, 1580, 160-90, 1880, 446, 45-66, 466, 50-66, 55-66, 55-90, 566, 580, 60-66, 60-90, 60-93, 60-94, 65-66, 65-90, 65-93, 65-94, 666, 680, 70-66, 70-90, 72-93, 72-94, 766, 780, 80-66, 80-90, 82-93, 82-94, 85-90, 880, 880-5, 88-93, 88-94, 90-90, 980
- varalasi T3045 (9929835)



TAKAVALO

F0660

82008066

- sopii: L60, 65, 75, 85, 95

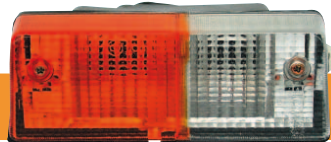

ETURAJAVALO

- pininfarina ohjaamo, 100-90, 110-90, 115-90, 1180, 1280, 130-90, 1380, 140-90, 1580, 160-90, 1880, 446, 45-66, 466, 50-66, 55-66, 55-90, 566, 580, 60-66, 60-90, 60-93, 60-94, 65-66, 65-90, 65-93, 65-94, 666, 680, 70-66, 70-90, 72-93, 72-94, 766, 780, 80-66, 80-90, 82-93, 82-94, 85-90, 880, 880-5, 88-93, 88-94, 90-90, 980

Vasen

T3041

4999858

- varalasi vasen T3042

Oikea

T3040

4999859

- varalasi oikea T3043

ETURAJAVALO

- cabina larga ohjaamo

Vasen

T3579

5116239

- varalasi oikea/vasen T3581



Oikea

T3580

5116238



UMPIO

F0657

5112013

- sopii: L60, 65, 75, 85, 95 TL70, 80, 90, 100

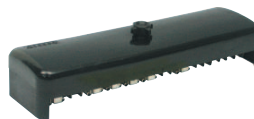

SULAKERASIA

T3753

4998859

- sopii: 90, 94 sarjat
- 12 sulakkeelle

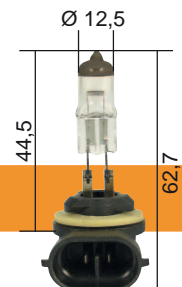

POLTTIMO

P12886

8200449

- työvaloon New Holland M-sarja
- 12,8V, 50W
- kanta PGJ13

C1.41

22.10.2010



OVEN LUKKO JA SISÄKAHVA

- 580-1880, 55-90 - 180-90
- kaikki mallit "Pininfarina" ohjaamolla

Vasen
T3080
5108380

Oikea
T3081
5108381



OVEN ULKOKAHVA

- 580-1880, 55-90 - 180-90
- kaikki mallit "Pininfarina" ohjaamolla

Vasen
T3076
5108382

Oikea
T3077
5108392



OVEN PYSÄYTTIMET

Jousi
FT5108410
5108410
- 80-sarja

Vaijeri
FT5120144
5120144
- 90-94 sarjat

Jousi
FT5120172
5120172
- 90-94 sarjat

OHJAAMON KUMITYYNY



T3090
4997423

- 100-90, 110-90, 4635, 4835, 55-88, 55-90, 5635, 60-88, 60-90, 60-93, 60-94, 65-88, 65-90, 65-93, 65-94, 6635, 70-80, 70-90, 72-93, 72-94, 7635, 80-88, 80-90, 82-93, 82-94, 85-90, 88-93, 88-94, 90-90, L60, L65, L75, L85, L95, TL100, TL70, TL80, TL90



TUNTIMITTARIN KULMAVAIHDE

T3752

598816, 5109356

- 466, 566, 580, 666, 680, 780, 880, 980, 35-66, 45-66, 50-66, 55-46, 55-66, 55-88, 55-90, 60-46, 60-66, 60-76, 60-86, 60-90, 60-93, 60-94, 65-46, 65-56, 65-66, 65-88, 65-90, 65-93, 65-94, 70-56, 70-66, 70-88, 72-86, 72-93, 72-94, 80-66, 80-76, 80-88, 80-90, 82-86, 82-93, 82-94, 85-90, 88-93, 88-94, 90-90, 100-90, 110-90, 115-90, 130-90, 140-90, F100, F110, F115, F120, F130, F140, L60, L65, L75, L85, L95



ETUMASKI

T3060

5175979

- suorakaidelyhdyille
- maalattu
- sopii 580-980, 55-90 - 110-90

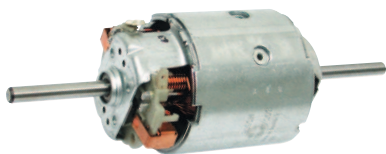

LÄMMITYSLAITTEEN MOOTTORI

T3565

- 580-1880, 55-90 - 180-90
- kaikki mallit "Pininfarina" ohjaamolla
- vastus **T3565A**

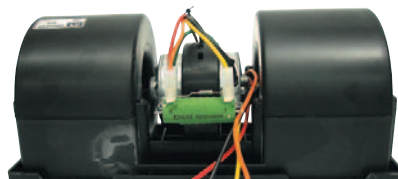

OHJAAMON TÄYDELLINEN PUHALLIN

F0654

82034854
- sopii: M100, 115, 135, 160
TM115, 120, 125, 130, 140

LÄMMITYSLAITTEEN HANA

T3751

9961515

- 55-90, 55-90DT, 140-90, 140-90DT, 180-90, 180-90DT, 70-90, 70-90DT, 100-90, 100-90DT, 580, 580DT, 980, 980DT



25.07.2008



PEILI VARRELLA

- 80 ja 90 -sarjat
- sisältää kiinnityspalan

Vasen
T3634
5108722

Oikea
T3633
5108721

Peili
T1527
5126233



KATTOLUUKUN KAHVA

T3082

5178614

- 580-1880, 55-90 - 180-90
- kaikki mallit "Pininfarina" ohjaamolla



PEILI

F0599

82014840

- NH 60- ja M-sarjat,
TM175, 190,
TS110, 115, 125A, 130A, 135A
- varapeili F0601

PEILIN VARSII

Vasen
F0595
82014839

Oikea
F0596
82014838



PEILI

F0600

82014587

- NH 60-, -70, M, TM- ja
TS-sarjat
- varapeili T2420

PEILIN TELESKOOPPI- VARSII

Vasen
F0597
82014589

Oikea
F0598
82014588

TAKALASIN KAHVA

T3708

5113656, 5178432

- 580-1880, 55-90 - 180-90
- osittain mallit "Pininfarina" ohjaamolla



TAKALASIN SARANA

T3079

5122998

- 580-1880, 55-90 - 180-90
- kaikki mallit "Pininfarina" ohjaamolla



PYYHKIMEN SULKA

VLC3228

5139806

- sopii: 580, 680, 780, 880, 880-5, 980 pininfarina
1180, 1380 pininfarina, 1580, 1880 (pininfarina)
Fiatagri 55-90, 60-90, 65-90, 70-90, 80-90 kapea ohjaamo
Fiatagri 70-, 80-, 85-, 90-, 100-, 110-, 115-, 130-, 140-,
160-, 180-90 CL-ohjaamot



PYYHKIMEN SULKA

VLC3225

5144385

- sopii: Winner F100, F110, F120, F130, F140

25.07.2008



T3078



T3619



VPM1689

TRAKTORI- MALLI	TAKALASIN SYLINTERI	KATTOLUUKUN SYLINTERI	OVEN SYLINTERI
580, 680, 780, 880, 880-5, 980 pininfarina	T3078 KS0113 5129427	T3619 KS0114 5125289	
1180, 1380 pininfarina	T3078 KS0113 5129427	T3619 KS0114 5125289	
1580, 1880 (pininfarina)	T3078 KS0113 5129427	T3619 KS0114 5125289	
Fiat-agri 55-90, 60-90, 65-90, 70-90, 80-90 kapea ohj.	T3078 KS0113 5129427	T3619 KS0114 5125289	
Fiat-agri 70-, 80-, 85-, 90-, 100-, 110-, 115-, 130-, 140-, 160-, 180-90 CL-ohjaamot	T3078 KS0113 5129427	T3619 KS0114 5125289	
Winner F100, F110, F120, F130, F140	KS0143 5153193	KS0144 5153206	VPM1689 KS0142 5147419

08.05.2009



Fiatagri CS2 & CS2/1-ohjaamot (Pininfarina)

580, 680, 780, 880, 980, 55-90 - 80-90

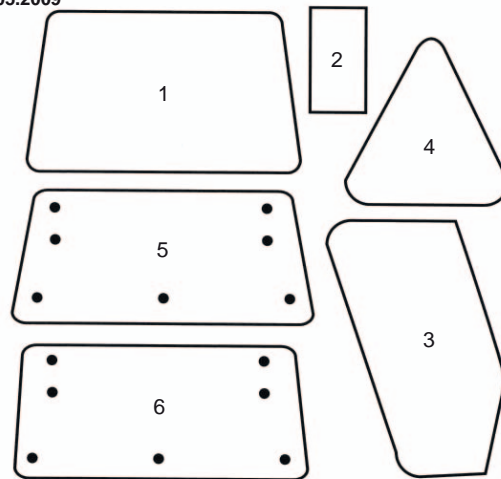

	TUOTE-NRO	LASI	KUVAUS	ALKUPERÄIS-NUMERO	KOKO mm (k ork. x lev. x vahv.)	VÄRI	KIINNITYS
1	T3760 (d)	Tuulilasi		5108663	1100 x 660 x 6	kirkas	T
2	T3761 (d)	Alempi etu	vas. & oik.	5108667	584 x 211 x 5	kirkas	T
3	T3657	Oven	vas. & oik., kaareva	5108670/5108669	1165 x 565 x 4	kirkas	T
4	T3762	Sivulasi	oik., kaareva	5108673	601 x 484 x 4	kirkas	T
4	T3763	Sivulasi	vas., kaareva	5108674	601 x 484 x 4	kirkas	T
5	T3583 (b)	Ylempi taka	7 reikää	5108627	1088 x 600 x 6	kirkas	R/PK
6	T3764 (a, c)	Ylempi taka	7 reikää	5121385	1063 x 597 x 6	kirkas	R/PK

- a - korvaa numeron 5113393
 b - sarjanumeroon →9000
 c - sarjanumerosta 9001→
 d - 55-90 - 80-90 Pininfarina-ohjaamolla

Ylläolevat mallit sopivat myös seuraaviin CS-ohjaamotyyppisiin, erotuksena sävytetty väri:

- 1 & 2 ohjaamotyyppisiin CS8, 11 & 15
- 3 ohjaamotyyppisiin CS5, 6, 8 & 9
- 4 ohjaamotyyppiin CS8
- 6 ohjaamotyyppisiin CS8 & 15

Fiatagri CS3-ohjaamot

1180, 1280, 1380, 1580, 1880

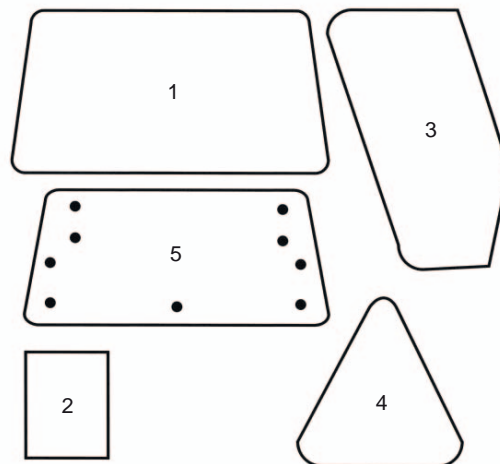

	TUOTE-NRO	LASI	KUVAUS	ALKUPERÄIS-NUMERO	KOKO mm (k ork. x lev. x vahv.)	VÄRI	KIINNITYS
1	T3765	Tuulilasi		5113401	1405 x 660 x 6	kirkas	T
2	T3766	Alempi etu	vas. & oik.	5113402	584 x 364 x 5	kirkas	T
3	T3657	Oven	vas. & oik., kaareva	5108670/5108669	1165 x 565 x 4	kirkas	T
4	T3762	Sivulasi	oik., kaareva	5108673	601 x 484 x 4	kirkas	T
4	T3763	Sivulasi	vas., kaareva	5108674	601 x 484 x 4	kirkas	T
5	T3767	Ylempi taka	9 reikää	5113403	1367 x 595 x 6	kirkas	R/PK

Ylläolevat mallit sopivat myös seuraaviin CS-ohjaamotyyppisiin, erotuksena sävytetty väri:

- 1 & 2 ohjaamotyyppisiin CS5, 6 & 9
- 3 ohjaamotyyppisiin CS5, 6, 7, 8 & 9
- 4 ohjaamotyyppiin CS8
- 5 ohjaamotyyppisiin CS5, 6 & 9

Kiinnitystavat: L = liimattu
 PK = pulttikiinnitys
 K = kehyksellä
 T = tiivisteellä
 R = reunasuojalla

C1.45

12.01.2009



Fiatagri CL-ohjaamot

70-90, 80-90, 90-90,
100-90, 115-90, 180-90

Alla olevat mallit sopivat myös seuraaviin CL-ohjaamotyyppeihin, erotuksena eri sävy:

- 1 & 2 ohjaamotyyppeihin CS5, 6 & 9
- 3 & 4 ohjaamotyyppeihin CS15

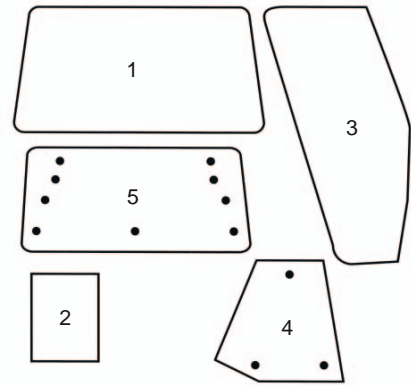

	TUOTE-NRO	LASI	KUVAUS	ALKUPERÄIS-NUMERO	KOKO mm (k ork. x lev. x vahv.)	VÄRI	KIINNITYS
1	T3765	Tuulilasi		5113401	1405 x 660 x 6	kirkas	T
2	T3766	Alempi etu	vas. & oik.	5113402	584 x 364 x 5	kirkas	T
3	T3658	Oven	vas. & oik., kaareva	5130884/5130883	1355 x 540 x 4	sävytetty	T
4	T3768 (a)	Sivulasi	vas. & oik., 3 reikää	5165571	598 x 555 x 4	sävytetty	R/PK
5	T3584	Ylempi taka	9 reikää	5130388	1367 x 595 x 6	kirkas	R/PK

a - korvaa numerot 5130773 & 5130895

Fiat Winner

TAKALASI

T3701

5154756

- Fiat Winner F100, F110, F120, F130, F140

OVEN LASI

T3702

5154934

- Fiat Winner F100, F110, F120, F130, F140



L-sarja

60, 65, 75, 85, 95

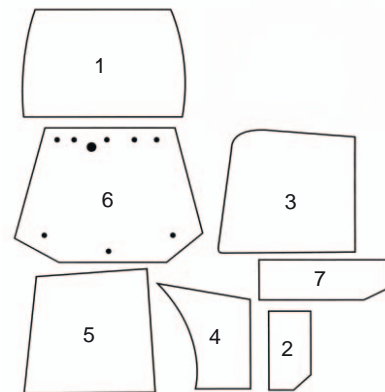

	TUOTE-NRO	LASI	KUVAUS	ALKUPERÄIS-NUMERO	KOKO mm (k ork. x lev. x vahv.)	VÄRI	KIINNITYS
1	F0635	Tuulilasi	kiinteä, ei avattava, kaareva	82002183	1154 x 827 x 5	sävytetty	L
2	F0636	Alempi etu	oik.	82002184	652 x 340 x 5	sävytetty	L
2	F0637	Alempi etu	vas.	82002185	652 x 340 x 5	sävytetty	L
3	F0638	Ylempi oven	oik., kaareva	82002179	870 x 782 x 5	sävytetty	L
3	F0639	Ylempi oven	vas., kaareva	82002180	870 x 782 x 5	sävytetty	L
4	F0640	Alempi oven	oik.	82002181	787 x 630 x 5	sävytetty	L
4	F0641	Alempi oven	vas.	82002182	787 x 630 x 5	sävytetty	L
5	F0642	Sivulasi	oik., kaareva	82002229	780 x 652 x 5	sävytetty	L
5	F0643	Sivulasi	vas., kaareva	82002230	780 x 652 x 5	sävytetty	L
6	F82005316 (a)	Ylempi taka	9 reikää	5178304	1503 x 905 x 5	sävytetty	R/PK
7	F0644	Alempi taka		82000485	703 x 299 x 5	sävytetty	L

a - korvaa numeron 82005316

Kiinnitystavat: L = liimattu

PK = pulttikiinnitys

K = kehyksellä

T = tiivisteellä

R = reunasuojalla

C1.46

Alkuperäisnumerot ovat ainoastaan vertailua varten, eivätkä tarkoituksena, että tuotteet ovat alkuperäisiä.

Taulukoissa esiintyvät kuvat ovat viitteellisiä.

TL-sarja 70, 80, 90, 100

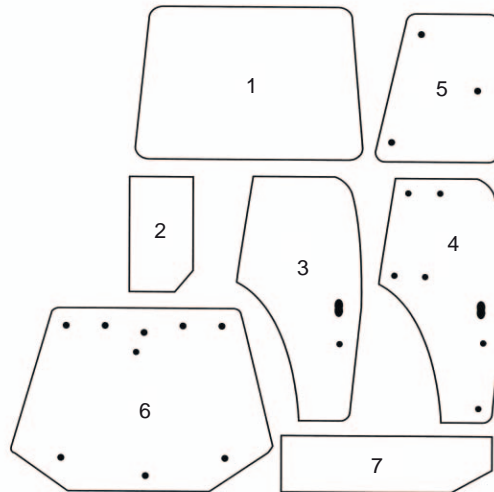

	TUOTE-NRO	LASI	KUVAUS	ALKUPERÄIS-NUMERO	KOKO mm (k ork. x lev. x vahv.)	VÄRI	KIINNITYS
1	F0635	Tuulilasi	kaareva	82002183	1154 x 827 x 5	sävytetty	L
2	F0636	Alempi etu	oik.	82002184	652 x 340 x 5	sävytetty	L
2	F0637	Alempi etu	vas.	82002185	652 x 340 x 5	sävytetty	L
3	F0630 (a)	Oven	vas., 2 reikää, kaareva	82000396	1492 x 842 x 5	sävytetty	L
3	F0631 (a)	Oven	oik., 2 reikää, kaareva	82000367	1492 x 842 x 5	sävytetty	L
4	F0604 (b)	Oven	oik., 7 reikää, kaareva	82019225	1560 x 875 x 5	sävytetty	PK
4	F0603 (b)	Oven	vas., 7 reikää, kaareva	82019226	1560 x 875 x 5	sävytetty	PK
5	F0648	Sivulasi	vas., 3 reikää, kaareva	5182189	725 x 637 x 5	sävytetty	PK
5	F0649	Sivulasi	oik., 3 reikää, kaareva	5182188	725 x 637 x 5	sävytetty	PK
6	F82005316 (c)	Ylempi taka	9 reikää	5178304	1503 x 905 x 5	sävytetty	R/PK
7	F0644	Alempi taka		82000485	703 x 299 x 5	sävytetty	L

a - ovi kehyksellä b - ilman kehystä c - 11/95 → alareikien väli 1077 mm

TM-sarja

115, 125, 135, 150, 165

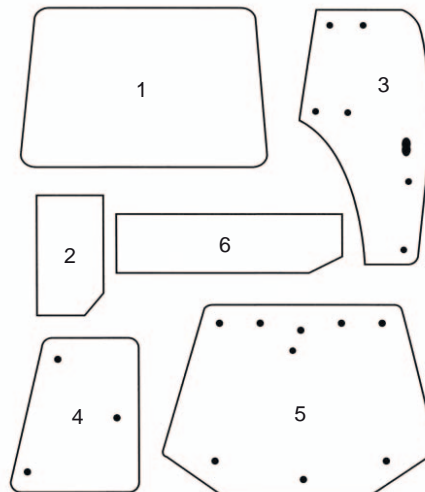

	TUOTE-NRO	LASI	KUVAUS	ALKUPERÄIS-NUMERO	KOKO mm (k ork. x lev. x vahv.)	VÄRI	KIINNITYS
1	F0645	Tuulilasi	kaareva	82000296	1154 x 840 x 5	sävytetty	L
2	F0646	Alempi etu	oik.	82001924	652 x 340 x 6	sävytetty	L
2	F0647	Alempi etu	vas.	82001923	652 x 340 x 6	sävytetty	L
3	F0604	Oven	oik., 7 reikää, kaareva	82019225	1560 x 875 x 5	sävytetty	PK
3	F0603	Oven	vas., 7 reikää, kaareva	82019226	1560 x 875 x 5	sävytetty	PK
4	F0632	Sivulasi	vas., 3 reikää, kaareva	82009813	775 x 650 x 5	sävytetty	PK
4	F0633	Sivulasi	oik., 3 reikää, kaareva	82009812	775 x 650 x 5	sävytetty	PK
5	F82005316	Ylempi taka	9 reikää	82014988	1503 x 905 x 5	sävytetty	R/PK
6	F0644	Alempi taka		82000485	703 x 299 x 5	sävytetty	L

Kiinnitystavat: L = liimattu PK = pulttikiinnitys

K = kehyksellä T = tiivisteellä R = reunasuojalla

C1.47

Alkuperäisnumerot ovat ainoastaan vertailua varten, eivätkä tarkoita, että tuotteet ovat alkuperäisiä.
Taulukoissa esiintyvät kuvat ovat viitteellisiä.

21.09.2009

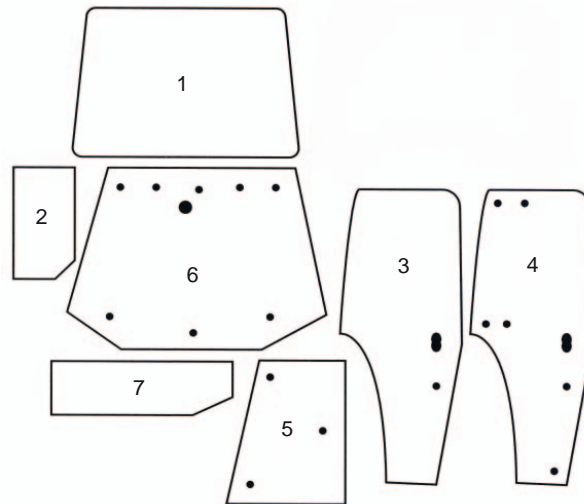

Fiatagri M-sarja

100, 115, 135, 160

	TUOTE-NRO	LASI	KUVAUS	ALKUPERÄIS- NUMERO	KOKO mm (k ork. x lev. x vahv.)	VÄRI	KIINNITYS
1	F0645	Tuulilasi	kiinteä, ei avettava, kaareva	82000296	1154 x 840 x 5	sävytetty	L
2	F0646	Alempi etu	oik.	82001924	652 x 340 x 6	sävytetty	L
2	F0647	Alempi etu	vas.	82001923	652 x 340 x 5	sävytetty	L
3	F0630 (d)	Oven	vas., 2 reikää, kaareva	82000396	1492 x 842 x 5	sävytetty	L
3	F0631 (d)	Oven	oik., 2 reikää, kaareva	82000367	1492 x 842 x 5	sävytetty	L
4	F0604	Oven	oik., 7 reikää, kaareva	82036000	1535 x 875 x 5	sävytetty	FK
4	F0603	Oven	vas., 7 reikää, kaareva	82036001	1535 x 875 x 5	sävytetty	FK
5	F0632 (a)	Sivulasi	oik., 3 reikää, kaareva	82009813	775 x 650 x 5	sävytetty	FK
5	F0633 (b)	Sivulasi	vas., 3 reikää, kaareva	82009812	775 x 650 x 5	sävytetty	FK
6	F82005316 (c,e)	Ylempi taka	9 reikää	5178304	1503 x 905 x 5	sävytetty	R/PK
7	F0644	Alempi taka		82000485	703 x 299 x 5	sävytetty	L

- a - korvaa numeron 83995322
 b - korvaa numeron 83995321
 c - korvaa numeron 82005316
 d - kehyksellä oleva ei tuotu Suomeen
 e - 11/95 → alareikien väli 1077 mm

Kiinnitystavat: L = liimattu
 PK = pulttikiinnitys
 K = kehyksellä
 T = tiivisteellä
 R = reunasuojalla

TUULILASILIIMASARJA

HK269

- annostellaan kylmänä, valumaton
- max. kiinnitysaika 25 min
- ajovalmuisaika 2 h
- sisältö: puhdistusaine 20 ml, puhdistusliina, primer 10 ml, primer-levitin, liima 310 ml



C1.48

26.09.2011

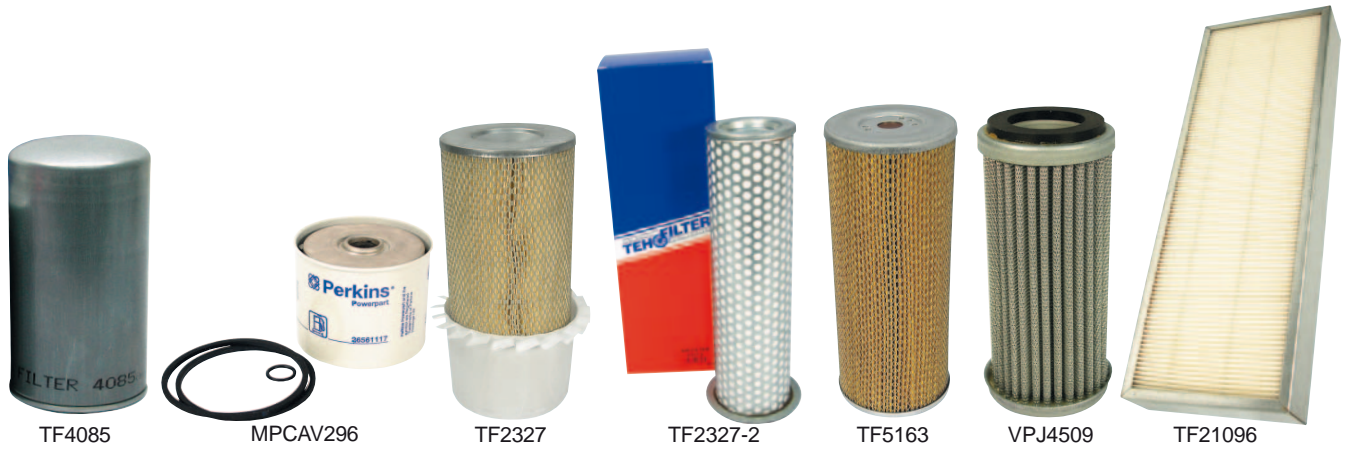

TRAKTORI-MALLI	ÖLJYN-SUODATIN	POLTTO-AINE-SUODATIN	ILMANSUODATIN ULOMPI	ILMANSUODATIN SISEMPI	HYDRAULIIKKA-SUODATIN	OHJAUKSEN SUODATIN	OHJAAMON SUODATIN
18		TF7077 1909112					
25R, 215	TF5006 1909104	TF7077 1909112					
211, 311, 312 411, 441	TF5006 1909104	TF7022 (x1) 1909108 TF7077 (x1) 1909112					
250, 300	TF4076 DFP553411 FT1909102 1909102	MPCAV296 DFP556245 1909100					
315		TF7077 1909112					
415	TF5006 1909104	TF7022 (x1) 1909108 TF8018 (x1) 1909113					
450, 500, 550, 600, 640	TF4085 DFP554407 1909101	MPCAV296 (x2) DFP556245 (x2) 1909100					
513R, 615	TF5041 1909123						
650, 750, 850	TF4085 DFP554407 1909101	TF6099 1909103					
1000, 1000S	TF4076 (x2) DFP553411 FT1909102 1909102	MPCAV296 (x2) DFP556245 (x2) 1909100					
1300, 1300S	TF4085 (x2) DFP554407 1909101	TF6099 1909103 FT1909107 1909107					
480	TF4085 DFP554407 1909101	MPCAV296 (x2) DFP556245 (x2) 1909100					
580, 680, 780, 880	TF4085 DFP554407 1909101	MPCAV296 (x2) DFP556245 (x2) 1909100	TF2327 1909116	TF2327-2 DFP127787 1909117	TF5163 1909106	VPJ4509 (h) 1909143	TF21096 (x2) 1930782 TF21124 (m)
880/5, 980	TF4076 (x2) DFP553411 FT1909102 1909102	MPCAV296 (x2) DFP556245 (x2) 1909100 TF6206 (x2) DFP550588 1930010	TF2327 1909116	TF2327-2 DFP127787 1909117	TF5163 1909106	VPJ4509 (h) 1909143	TF21096 (x2) 1930782

Katso huomautukset sivulta C1.52

C1.49

Alkuperäisnumerot ovat ainoastaan vertailua varten, eivätkä tarkoituksenaan, että tuotteet ovat alkuperäisiä.
Taulukoissa esiintyvät kuvat ovat viitteellisiä.

26.09.2011

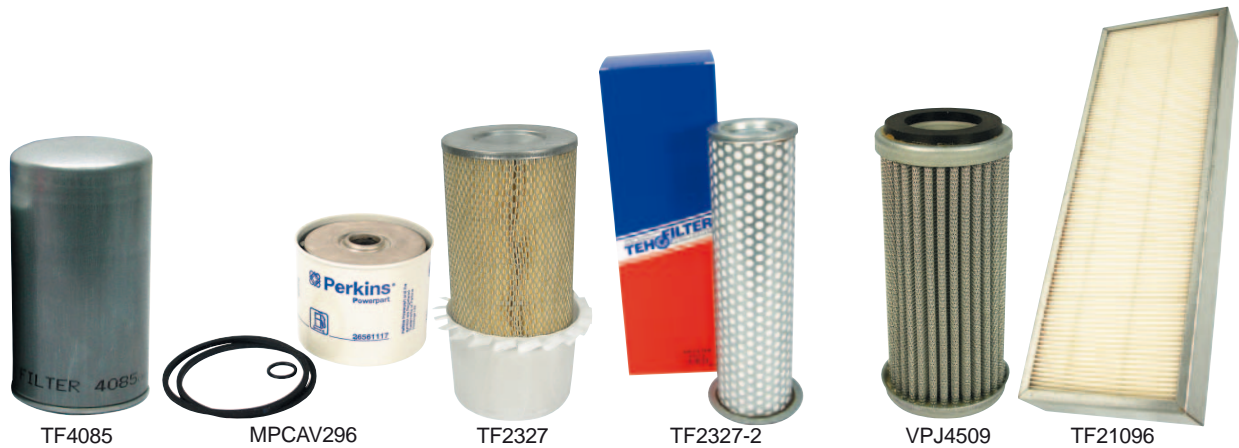

TF4085

MPCAV296

TF2327

TF2327-2

VPJ4509

TF21096

TRAKTORI-MALLI	ÖLJYN-SUODATIN	POLTTO-AINE-SUODATIN	ILMANSUODATIN ULOMPI	ILMANSUODATIN SISEMPI	HYDRAULIIKKA-SUODATIN	OHJAUKSEN SUODATIN	OHJAAMON SUODATIN
1180, 1380	TF4076 (x2) DFP553411 FT1909102 1909102	MPCAV296 (x2) DFP556245 (x2) 1909100 TF6206 (x2) DFP550588 1930010	TF2113 1909136	TF2113-2 1930175	TF4159 1909130	VPJ4509 (h) 1909143	TF21096 (x2) 1930782
1580, 1880	TF4117 1930544	TF6099 (x1) 1909103 FT1909107 (x1) 1909107	TF2113 1909136	TF2113-2 1930175	TF4159 (x2) 1909130	VPJ4509 (h) 1909143	TF21096 (x2) 1930782
55-90, 60-90 65-90	TF4085 DFP554407 1909101	MPCAV296 (x2) DFP556245 (x2) 1909100 FT1930581 (a) 1930581	TF2342 DFP772535 1930138	TF2327-2 DFP127787 1909117	TF4159 1909130	VPJ4509 (h) 1909143	TF21096 (b) 1930782 FT5141540 (c) 5141540
70-90, 80-90	TF4085 DFP554407 1909101	MPCAV296 (x2) DFP556245 (x2) 1909100 FT1930581 (a) 1930581	TF2342 (d) DFP772535 1930138 TF2327 1909116	TF2327-2 DFP127787 1909117	TF4159 (x2) 1909130	VPJ4509 (h) 1909143	TF21096 (b) 1930782 FT5141540 (c) 5141540
85-90	TF4076 DFP553411 FT1909102 1909102	MPCAV296 (x2) DFP556245 (x2) 1909100 FT1930581 (a) 1930581	TF2327 (f) 1930116 TF2701 (g) DFP828889 1930589	TF2327-2 (f) DFP127787 1930117 TF2677-2 (g) DFP829333 1930590	TF4159 1909130	VPJ4509 (h) 1909143	FT5141540 (x2) 5141540
90-90	TF4076 (x2) DFP553411 FT1909102 1909102	TF6206 (x2) DFP550588 1930010 FT1930581 (a) 1930581	TF2342 (d) DFP772535 1930138 TF2327 1909116	TF2327-2 DFP127787 1909117	TF4159 1909130	VPJ4509 (h) 1909143	TF21096 (b) 1930782 FT5141540 (c) 5141540
100-90, 110-90	TF4076 (x2) DFP553411 FT1909102 1909102	TF6206 (x2) DFP550588 1930010 FT1930581 (a) 1930581	TF2342 (d) DFP772535 1930138 TF2327 1909116	TF2327-2 DFP127787 1909117	TF4159 1909130	VPJ4509 (h) 1909143	TF21096 (b) 1930782 FT5141540 (c) 5141540
115-90	TF4076 (x2) DFP553411 FT1909102 1909102	MPCAV296 (x2) DFP556245 (x2) 1909100 FT1930581 (a) 1930581	TF2332 1930174	TF2113-2 1930175	TF4159 1909130	VPJ4509 (h) 1909143	TF21096 (b) 1930782 FT5141540 (c) 5141540
130-90, 140-90	TF4178 1930213	MPCAV296 (x2) DFP556245 (x2) 1909100 FT1930581 (a) 1930581	TF2332 1930174	TF2113-2 1930175	TF4159 1909130	VPJ4509 (h) 1909143	TF21096 (b) 1930782 FT5141540 (c) 5141540
160-90, 180-90	TF4117 1930544	TF6099 (x1) 1909103 FT1909107 (x1) 1909107 FT1930581 (a) 1930581	TF2332 1930174	TF2113-2 1930175	TF4159 (x3) 1909130	VPJ4509 (h) 1909143	TF21096 (b) 1930782 FT5141540 (c) 5141540

Katso huomautukset sivulta C1.52

C1.50

Alkuperäisnumerot ovat ainoastaan vertailua varten, eivätkä tarkoita, että tuotteet ovat alkuperäisiä. Taulukoissa esiintyvät kuvat ovat viitteellisiä.

26.09.2011



TF4085



MPCAV296



FT1930605



TF2327-2



TF1930882



VPJ4509



F83994694

TRAKTORI-MALLI	ÖLJYN-SUODATIN	POLTTO-AINE-SUODATIN	ILMANSUODATIN ULOMPI	ILMANSUODATIN SISEMPI	HYDRAULIIKKA-SUODATIN	OHJAUKSEN SUODATIN	OHJAAMON SUODATIN
65-94, 82-94	TF4085 DFP554407 1909101	MPCAV296 (x2) DFP556245 (x2) 1909100 FT1930581 (a) 1930581	TF2593 1930587	DFP775300 1930588	TF4159 1909130		FT5141540 (x2) 5141540
88-94	TF4076 DFP553411 FT1909102 1909102	MPCAV296 (x2) DFP556245 (x2) 1909100 TF6206 DFP550588 1930010 FT1930581 (a) 1930581	TF2701 DFP828889 1930589	TF2677-2 DFP829333 1930590	TF4159 1909130		FT5141540 (x2) 5141540
F110		DFP551430 (n)					
F100, F110, F115 F120	TF4076 (x2) DFP553411 FT1909102 1909102	TF6206 (x2) DFP550588 1930010 FT1930581 (a) 1930581	TF2701 DFP828889 1930589 FT1930605 (e) 1930605	TF2677-2 DFP829333 1930590 TF2327-2 (e) DFP127787 1930825	FT1930882 1930882		TF21131 (x2) 5124932
F130, F140	TF4178 (x2) 1930213	TF6206 (x2) DFP550588 1930010 FT1930581 (a) 1930581	TF21101 1930603	TF21101-1 1930790	FT1930882 1930882		TF21131 (x2) 5124932
L60	TF4085 DFP554407 1909101	TF6206 DFP550588 1930010 FT1930581 (a) 1930581	TF2593 (g) 1930587	DFP775300 (g) 1930588	FT1930986 1930986	VPJ4509 (h) 1909143	TF21182 (x2) 82012057 F83994694 (i) 83994694
L65, L75	TF4076 DFP553411 FT1909102 1909102	TF6206 DFP550588 1930010 FT1930581 (a) 1930581	TF2593 (g) 1930587	DFP775300 (g) 1930588	FT1930986 (x2) 1930986	VPJ4509 (h) 1909143	TF21182 (x2) 82012057 F83994694 (i) 83994694
L85, L95	TF4076 DFP553411 FT1909102 1909102	TF6206 DFP550588 1930010 FT1930581 (a) 1930581	FT1930605 (f) 1930605 TF2701 (g) DFP828889 1930589	TF2327-2 (f) DFP127787 1930825 TF2677-2 (g) DFP829333 1930590	FT1930986 (x2) 1930986	VPJ4509 (h) 1909143	TF21182 (x2) 82012057 F83994694 (i) 83994694
M100, M115	TF4015 81879134	F87840591 87840591 F87801341 (j) 87801341 F87840590 (k) 87840590	TF2567 82008600	VPD7112 82008601	DFP502224 82005016 DFP164378 81863799		TF21182 (x2) 82012057 F83994694 (i) 83994694
M135, M160	TF4015 81879134	F87840591 87840591 F87801341 (j) 87801341 F87840590 (k) 87840590	F82008606 82008606	F82008607 82008607	DFP502224 82005016 DFP164378 81863799		TF21182 (x2) 82012057 F83994694 (i) 83994694

Katso huomautukset sivulta C1.52

C1.51

Alkuperäisnumerot ovat ainoastaan vertailua varten, eivätkä tarkoita, että tuotteet ovat alkuperäisiä. Taulukoissa esiintyvät kuvat ovat viitteellisiä.



FIAT, FIATAGRI, NEW HOLLAND SUODATTIMET



26.09.2011

TRAKTORI-MALLI	ÖLJYN-SUODATIN	POLTTO-AINE-SUODATIN	ILMANSUODATIN ULOMPI	ILMANSUODATIN SISEMPI	HYDRAULIIKKA-SUODATIN	OHJAUKSEN SUODATIN	OHJAAMON SUODATIN
TL70, TL80	TF4076 DFP553411 FT1909102 1909102	TF6206 DFP550588 1930010 FT1930581 (a) 1930581	TF2593 (g) 1930587	DFP775300 (g) 1930588	FT1930986 (x3) 1930986	VPJ4509 (h) 1909143	F82014790(x2) 47128151 F83994694 (i) 82033107
TL90	TF4076 DFP553411 FT1909102 1909102	TF6206 DFP550588 1930010 FT1930581 (a) 1930581	TF2701 (g) DFP828889 1930589 FT1930605 (f) 1930605	TF2677-2 (g) DFP829333 1930590 TF2327-2 (f) DFP127787 1930825	FT1930986 (x3) 1930986	VPJ4509 (h) 1909143	F82014790(x2) 47128151 F83994694 (i) 82033107
TL100	TF4076 DFP553411 FT1909102 1909102	TF6206 DFP550588 1930010 FT1930581 (a) 1930581	TF2701 (g) DFP828889 1930589 FT1930605 (f) 1930605	TF2677-2 (g) DFP829333 1930590 TF2327-2 (f) DFP127787 1930825	FT1930986 (x2) 1930986	VPJ4509 (h) 1909143	F82014790(x2) 47128151 F83994694 (i) 82033107
TL70A TL80A TL90A TL100A					DFP169797 47128161		F82014790(x2) 47128151 F83994694 (i) 82033107
G170, G190, G210, G240	TF4015 81879134						

- a - veden erotin suodatin
b - 2 kpl/traktori -88 asti
c - 2 kpl/traktori -88 eteenpäin, muovinen nasta lukitus
d - kartiopääty, imuputki kotelon päädyistä
e - itsepuhdistuvalla ilmansuodattimen kotelolla
f - teräksisellä ilmansuodattimen kotelolla
g - muovisella ilmansuodattimen kotelolla

- h - säiliön imusuodatin
i - ohut esisuodatin
j - uudempi malli pa-pumppu suodattimen jalassa
k - toisiosuodatin
m - valkoinen ohjaamo
n - ensiösuodatin

TÄYDELLINEN POLTTOAINESUODATIN KAKSOISMALLI

F0560

81862754, 81866599, 2656818
- 1000, 115-90, 1180, 1280, 130-90, 1380, 140-90, 446, 450 Italian, 450R, 460, 466, 480, 500, 540, 550, 55-90, 566, 570, 580, 600, 60-66, 640, 65-66, 65-90, 65-93, 65-94, 666, 670, 680, 70-66, 70-90, 72-93, 72-94, 766, 780, 80-66, 80-66F, 80-76F, 80-90, 82-86F, 82-93, 82-94, 85-90, 880, 880-5, 88-93, 88-94, 900, 980



JÄÄHDYTYSNESTEEN SUODATIN

F83971970

83971970
- sopii M100, M115, M135, M160



SUODATIN MUUTOS

Suodatinpatruunan TF5163 korvaamiseen suodattimella TF4159 tarvittavat osat

Liitin nippa
FT5116767
5116767

Suodattimen jalka
FT5129631
5129631



C1.52

Alkuperäisnumerot ovat ainoastaan vertailua varten, eivätkä tarkoita, että tuotteet ovat alkuperäisiä. Taulukoissa esiintyvät kuvat ovat viitteellisiä.

04.03.2011

SYKLONI ESIPUHDISTIN

Esipuhdistin säästää koneen varsinaista ilmanpuhdistinta. Syklonissa ilma joutuu pyörivään liikkeeseen ja epäpuhtaudet jäävät syklonin pohjalle. Puhdistettava ajoittain.

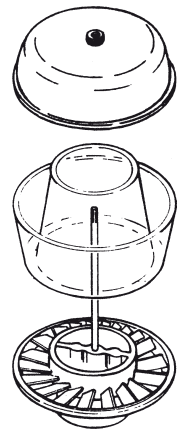

DFH001249

- putkikoko 3"/76 mm
- varalasi **DFP020227**

DFH000820

- putkikoko 3"/76 mm
- varalasi **DFP016330**

DFH000822

- putkikoko 4"/101 mm
- varalasi **DFP016330**

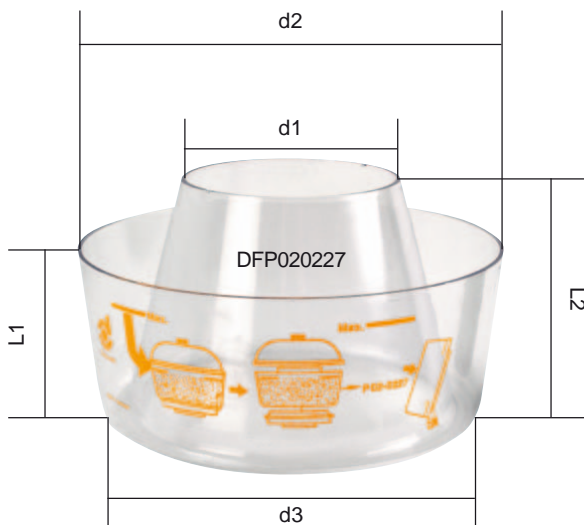

VARALASIEN MITAT

MITAT	DFP020227	DFP016330
d1 mm	90	141
d2 mm	183,5	266
d3 mm	140	217,5
L1 mm	77	75,5
L2 mm	106	101,5

VAIHTOEHTO ALKUPERÄISPAKKAUKSESSA

- DFP553411 = FT1909102
- TF4085 = FT1909101
- TF4159 = FT1909130
- TF4178 = FT1930213
- TF5163 = FT1909106
- TF6206 = FT1930010
- DFP502224 = F82005016