

## TRAKTORIMALLISTA MOOTTORITYYPPIIN

TRAKTORI-MALLI	SYLINTERI-LUKU	SYLINTERIN HALKAISIJA	MOOTTORI-TYYPPI
<b>UR1</b>			
2011			
2511	2	95	Z2001
3011, 3045	3	95	Z3001
3320			
3321			
3340			
3341			
3511, 3513, 3545	3	95	Z3001
4011			
4320			
4321			
4340			
43421			
4511, 4611	4	95	Z4001
4712, 4718	3	100	Z4701
4911	3	102	Z4901
5011	3	102	Z5001
5045			
5211	3	102	Z5201
5213			
5243			
5245	3	102	Z5201
5320			
5340			
5340H			
5341			
5511, 5611, 5645, 5647, 5711, 5718, 5745, 5748	4	95	Z5501
5911, 5945	4	100	Z5901
6011, 6045	4	100	Z6001
6211, 6245	4	100	Z6201
6320			
6321			
6340			
6341			
6711, 6718, 6745, 6748	4	100	Z6701
6911, 6945	4	102	Z6901
7011, 7045	4	102	Z7001
7045H			
7211, 7245	4	102	Z7201
7245H			
7320T			
7321			
7340T			
7341			
7711			
7711T	4	102	Z7701
7711T			
7745	4	102	Z7701
7745T			
<b>UR2</b>			
8011, 8045	4	110	Z8001
8111, 8145	4	110	Z8401.1 Z8401.134

TRAKTORI-MALLI	SYLINTERI-LUKU	SYLINTERIN HALKAISIJA	MOOTTORI-TYYPPI
8211, 8245			8401.12
9111			
9145			
9211, 9245			8002.13 TURBO
10011			
10045			
10111, 10145	4	110	Z8002.1 Z8002.134
10211, 10245			8002.12 TURBO
11211, 11245			8701.13
12011, 12045	6	110	Z8601
12111, 12145	6	110	Z8701.1
12211, 12245			8701.12
14145			
14245			8602.13 TURBO
16045			
16145	6	110	Z8602.1
16245			8602.12 TURBO
<b>UR3</b>			
7520			
7540			
8520T			
8540T			
8621			
8641			
95209520T			
9540			
9540T			
9621			
9641			
10520T			
10540T			
10641			
11641			
<b>UR4</b>			
8311, 8345			8403
10311, 10345			8004
11311, 11345,			8703
12311, 12345			
14345, 16345			8604
18345			8604.020
<b>URSUS</b>			
1201			U-1201
1204			U-1204
1214			
1222, 1224			Z8701.1
1232, 1233, 1234, 1235			Z8701.12
1252, 1254, 1352, 1354			Z8703
1435			Z8602.12
1552, 1554			Z8604.11
1614, 1634			Z8602.1 TURBO
1635			Z8602.12
1752, 1754			

25.07.2008



VPA1430



VPA1460



VPA2125



VPA2308

TRAKTORI- MALLI	MOOTTORI- TYYPPI	VENTTIILI		VENTTIILIN OHJURI		VENTTIILIN LUKKO
		IMU	PAKO	IMU	PAKO	IMU
<b>2 sylinteriset</b>						
2511	Z2001			VPA2129 950504	VPA2125 69010567	VPA2308 950510
<b>3 sylinteriset</b>						
3011, 3045	Z3001			VPA2129 950504	VPA2125 69010567	VPA2308 950510
3511, 3545 3513	Z3001			VPA2129 950504	VPA2125 69010567	VPA2308 950510
4712, 4718	Z4701			VPA2129 950504	VPA2125 69010567	VPA2308 950510
4911	Z4901	VPA1420 69010555	VPA1450 69010554	VPA2125 69010567	VPA2125 69010567	
5011	Z5001	VPA1420 69010555	VPA1450 69010554	VPA2125 69010567	VPA2125 69010567	
5211, 5245	Z5201	VPA1420 69010555	VPA1450 69010554	VPA2125 69010567	VPA2125 69010567	
<b>4 sylinteriset</b>						
4511, 4611	Z4001			VPA2129 950504	VPA2125 69010567	VPA2308 950510
5711, 5718 5745, 5748	Z5501			VPA2129 950504	VPA2125 69010567	VPA2308 950510
5511, 5611 5545, 5516 5645, 5647	Z5501			VPA2129 950504	VPA2125 69010567	
5911, 5945	Z5901	VPA1420 69010555	VPA1450 69010554	VPA2125 69010567	VPA2125 69010567	
6011, 6045	Z6001	VPA1420 69010555	VPA1450 69010554	VPA2125 69010567	VPA2125 69010567	
6211, 6245	Z6201	VPA1420 69010555	VPA1450 69010554	VPA2125 69010567	VPA2125 69010567	
6711, 6718 6745, 6748	Z6701			VPA2129 950504	VPA2125 69010567	
6911, 6945	Z6901	VPA1420 69010555	VPA1450 69010554	VPA2125 69010567	VPA2125 69010567	
7011, 7045	Z7001	VPA1420 69010555	VPA1450 69010554	VPA2125 69010567	VPA2125 69010567	
7211, 7245	Z7201	VPA1420 69010555	VPA1450 69010554	VPA2125 69010567	VPA2125 69010567	
7711, 7745	Z7701	VPA1420 (b) 69010555	VPA1450 (b) 69010554	VPA2125 69010567	VPA2125 69010567	
8011, 8045 385, 385A	Z8001	VPA1430 80005014	VPA1460 89005902	VPA2126 80005101	VPA2126 80005101	

Katso huomautukset sivulta I1.03

**I1.02**

Alkuperäisnumerot ovat ainoastaan vertailua varten, eivätkä tarkoita, että tuotteet ovat alkuperäisiä.  
Taulukoissa esiintyvät kuvat ovat viitteellisiä.

25.07.2008



VPA1430



VPA1460



VPA2128

TRAKTORI- MALLI	MOOTTORI- TYYPPI	VENTTIILI		VENTTIILIN OHJURI	
		IMU	PAKO	IMU	PAKO
4 sylinteriset jatkuu					
10111, 10145 1032, 1034 1132, 1134	Z8002.1	VPA1430 80005014	VPA1460 89005902		VPA2128 89005518
10111, 10145 1032, 1034 1132, 1134	Z8002.134				VPA2128 89005518
8111, 8145 932, 934 912, 914 914DL, 914DL turbo	Z8401.1	VPA1430 80005014	VPA1460 89005902		VPA2128 89005518
8111, 8145 932, 934 914DL, 914DL turbo	Z8401.134				VPA2128 89005518
6 sylinteriset					
12011, 12045 1201, 1204	Z8601	VPA1430 80005014	VPA1460 89005902	VPA2126 89005101	VPA2126 80005101
16145 1434, 1634	Z8602.1				VPA2128 89005518
1211, 12145 1232, 1234 1222, 1224	Z8701.1	VPA1430 80005014	VPA1460 89005902		VPA2128 89005518

b - ei Turbo-malliin.

25.07.2008



VPB9643

VPB1036

VPB7216

VPB2921

VPB4823

TRAKTORI-MALLI	MOOTTORI-TYYPPI	SYLINTERIN PUTKI-SARJA (j)	PUTKI (k)	O-RENGAS (l)	MÄNTÄ ilman renkaita	RENGAS-SARJA 3 rengasta (p)	RENGAS-SARJA 4 rengasta (p)	RENGAS-SARJA 5 rengasta (p)
2 sylinteriset								
2511	Z2001	VPB9641			VPB2920 (b, c) 55010334		VPB4820	VPB4822
3 sylinteriset								
3011, 3045	Z3001	VPB9641			VPB2920 (b, c) 55010334		VPB4820	VPB4822
3511, 3545 3513	Z3001	VPB9641			VPB2920 (b, c) 55010334		VPB4820	VPB4822
4712, 4718	Z4701	VPB9642	VPB1035 67010124	VPB7216 2 x 71010102	VPB2921 (a) 62010303	VPB4823		VPB4827
4911	Z4901	VPB9643	VPB1036 67010153	VPB7216 2 x 71010102	VPB2922 (a) 72010303	VPB4828	VPB4831	
5011	Z5001	VPB9643	VPB1036 67010168	VPB7216 2 x 71010102	VPB2922 (a) 72010303	VPB4828	VPB4831	
5211, 5245	Z5201	VPB9643	VPB1036 67010168	VPB7216 2 x 71010102	VPB2922 (a) 72010303	VPB4828	VPB4831	
4 sylinteriset								
4511, 4611	Z4001	VPB9641			VPB2920 (b, c) 55010334		VPB4820	VPB4822
5711, 5718 5745, 5748	Z5501	VPB9641			VPB2920 (e, b) 55010334		VPB4820	VPB4822
5511, 5545 5516, 5611 5645, 5647	Z5501	VPB9641			VPB2920 (b, c) 55010334		VPB4820	VPB4822
5911, 5945	Z5901	VPB9642	VPB1035 59010156	VPB7216 2 x 71010102	VPB2921 (a) 62010303	VPB4823		
6011, 6045	Z6001	VPB9642	VPB1035 59010156	VPB7216 2 x 71010102	VPB2921 (a) 62010303	VPB4823		
6211, 6245	Z6201	VPB9642	VPB1035 59010156	VPB7216 2 x 71010102	VPB2921 (a) 62010303	VPB4823		
6711, 6718 6745, 6748	Z6701	VPB9642	VPB1035 67010124	VPB7216 2 x 71010102	VPB2921 (a, f) 62010303	VPB4823		VPB4827
6911, 6945	Z6901	VPB9643	VPB1036 69010153	VPB7216 2 x 71010102	VPB2922 (a) 72010303	VPB4828	VPB4831	
7011, 7045	Z7001	VPB9643	VPB1036 69010168	VPB7216 2 x 71010102	VPB2922 (a) 72010303	VPB4828	VPB4831	
7211, 7245	Z7201	VPB9643	VPB1036 69010168	VPB7216 2 x 71010102	VPB2922 (a) 72010303	VPB4828	VPB4831	
7711, 7745	Z7701		VPB1036 69010168	VPB7216 2 x 71010102		VPB4828 (n)		
8011, 8045 385, 385A	Z8001	VPB9645 (h)	VPB1037 89002002			VPB4832 (h)	VPB4835 (g)	

Katso huomautukset sivulta I1.05

21.09.2009



TRAKTORI-MALLI	MOOTTORI-TYYPPI	SYLINDERIN PUTKI-SARJA (j)	PUTKI (k)	RENGAS-SARJA 3 rengasta (p)	RENGAS-SARJA 4 rengasta (p)
<b>4 sylinteriset jatkuu</b>					
10111, 10145 1032, 1034 1132, 1134	Z8002.1	VPB9646	VPB1037 89002002	VPB4833	
10111, 10145 1032, 1034 1132, 1134	Z8002.134	VPB9646	VPB1037 89002002	VPB4833	
8111, 8145 932, 934, 912, 914, 914 DL, 914 DL turbo	Z8401.1	VPB9646	VPB1037 89002002	VPB4833	
8111, 8145 932, 934, 914 DL, 914 DL turbo	Z8401.134	VPB9646	VPB1037 89002002	VPB4833	
<b>6 sylinteriset</b>					
12011, 12045 1201, 1204	Z8601	VPB9645 (h)	VPB1037 89002002		
16145 1434, 1634	Z8602.1	VPB9646	VPB1037 89002002	VPB4833	
12111, 12145 1232, 1234 1222, 1224	Z8701.1	VPB9646	VPB1037 89002002	VPB4833	

- a - 3-renkainen mäntä (suoralla ylärengasuralla)  
 b - 4-renkainen mäntä  
 c - korvaa 5-renkaisen männän  
 e - 5-renkainen mäntä, jota on käytetty valmistusnumeroissa 1001-54271, korvataan nyt uudella 4-renkaisella männällä  
 f - 5-renkainen mäntä, jota on käytetty valmistusnumeroissa 1001-20197 sekä 4-renkainen mäntä, jota on käytetty sarjanumerosta 20198 alkaen, korvataan nyt uudella 3-renkaisella männällä

- g - käytetään vanhemmissa Crystal-moottoreissa  
 h - käytetään uudemmissa Crystal-moottoreissa, valmistusnumerosta 9378 eteenpäin  
 j - sisältää 1 kpl putken, 1 kpl männän, 1 srj renkaat sekä 2 kpl o-renkaita  
 k - sisältää o-renkaat  
 l - pakkaus yhdelle putkelle 2 kpl o-renkaita  
 n - ilman turboa  
 p - katso oheinen kuva

## RENGASSARJAT

	VPB4822	VPB4820	VPB4827	VPB4823	VPB4828	VPB4831	VPB4835	VPB4832	VPB4833
T									
2									
3									
4									
5									

11.05



T6029



VPC4734



VPD1028

TRAKTORI- MALLI	MOOTTORI- TYYPPI	RUNKOLAAKERISARJA			PÄITÄISLAAKERI- SARJA STD	ÖLJY- PUMPPU
		STD	-0,25 mm	-0,50 mm		
<b>2 sylinteriset</b>						
2511	Z2001	T6027	T6028A (a)	T6028B (a)	VPC4734	
<b>3 sylinteriset</b>						
3011, 3045	Z3001	T6027	T6028A (a)	T6028B (a)	VPC4734 (b)	
3511, 3545 3513	Z3001	T6027	T6028A (a)	T6028B (a)	VPC4734	
4712, 4718	Z4701	T6027	T6028A (a)	T6028B (a)	VPC4734	
4911	Z4901	T6027	T6028A (a)	T6028B (a)	VPC4734	
5011	Z5001	T6027	T6028A (a)	T6028B (a)	VPC4734	
5211, 5245	Z5201	T6027	T6028A (a)	T6028B (a)	VPC4734	
<b>4 sylinteriset</b>						
4511, 4611	Z4001	T6028	T6028A	T6028B	VPC4734	
5711, 5718 5745, 5748	Z5501	T6028	T6028A	T6028B	VPC4734	VPD1028 55010798
5511, 5545 5516, 5611 5645, 5647	Z5501	T6028	T6028A	T6028B	VPC4734	VPD1028 55010798
5911, 5945	Z5901	T6028	T6028A	T6028B	VPC4734	VPD1028 55010798
6011, 6045	Z6001	T6028	T6028A	T6028B	VPC4734	VPD1028 55010798
6211, 6245	Z6201	T6028	T6028A	T6028B	VPC4734	VPD1028 69010734
6711, 6718 6745, 6748	Z6701	T6028	T6028A	T6028B	VPC4734	VPD1028 55010798
6911, 6945	Z6901	T6028	T6028A	T6028B	VPC4734	VPD1028 55010798
7011, 7045	Z7001	T6028	T6028A	T6028B	VPC4734	VPD1028 55010798
7211, 7245	Z7201	T6028	T6028A	T6028B	VPC4734	VPD1028 69010734
7711, 7745	Z7701	T6028	T6028A	T6028B	VPC4734	
8011, 8045 385, 385A	Z8001	T6029	T6029A	T6029B	VPC4737	
10111, 10145 1032, 1034, 1132, 1134	Z8002.1	T6029	T6029A	T6029B	VPC4737	
10111, 10145 1032, 1034, 1132, 1134	Z8002.134	T6030 (c)	T6030A (c)		VPC4737	

Katso huomautukset sivulta I1.07

25.07.2008



T6029



VPC4734

TRAKTORI- MALLI	MOOTTORI- TYYPPI	RUNKOLAAKERISARJA			PÄITTÄISLAAKERI- SARJA STD
		STD	-0,25 mm	-0,50 mm	
<b>4 sylinteriset jatkuu</b>					
8111, 8145 932, 934, 912 914, 914DL, 914DL Turbo	Z8401.1	T6029	T6029A	T6029B	VPC4737
8111, 8145 932, 934, 914DL, 914DL Turbo	Z8401.134	T6030 (c)	T6030A (c)		VPC4737
<b>6 sylinteriset</b>					
12011, 12045 1201, 1204	Z8601	T6030	T6030A		VPC4737
16145 1434, 1634	Z8602.1	T6030	T6030A		VPC4737
12111, 12145 1232, 1234 1222, 1224	Z8701.1	T6030	T6030A		VPC4737

a - käytetään 4-sylinterisen sarjaa

b - vanhemmat moottorit kapealla välilevyllä = tilaa 2 sarjaa

c - 4-syl. moottoreissa käytetään 6-syl. laakerisarjaa

25.07.2008



VPB7019



T6025

TRAKTORI-MALLI	MOOTTORI-TYYPPI	KIERTO-KANGEN HELA	KK-LAAKERIPARI		
			STD	-0,25 mm	-0,50 mm
<b>2 sylinteriset</b>					
2511	Z2001	<b>VPB7019</b> 950311	<b>T6025</b> 55010304	<b>T6025A</b> 55010399	
<b>3 sylinteriset</b>					
3011, 3045	Z3001	<b>VPB7019</b> 950311	<b>T6025</b> 55010304	<b>T6025A</b> 55010399	
3511, 3545, 3513	Z3001	<b>VPB7019</b> 950311	<b>T6025</b> 55010304	<b>T6025A</b> 55010399	
4712, 4718	Z4701	<b>VPB7019</b> 950311	<b>T6025</b> 55010304	<b>T6025A</b> 55010399	
4911	Z4901	<b>VPB7019</b> 950311	<b>T6025</b> 55010304	<b>T6025A</b> 55010399	
5011	Z5001	<b>VPB7019</b> 950311	<b>T6025</b> 55010304	<b>T6025A</b> 55010399	
5211, 5245	Z5201	<b>VPB7019</b> 950311	<b>T6025</b> 55010304	<b>T6025A</b> 55010399	
<b>4 sylinteriset</b>					
4511, 4611	Z4001	<b>VPB7019</b> 950311	<b>T6025</b> 55010304	<b>T6025A</b> 55010399	
5711, 5718 5745, 5748	Z5501	<b>VPB7019</b> 950311	<b>T6025</b> 55010304	<b>T6025A</b> 55010399	
5511, 5545 5516, 5611 5645, 5647	Z5501	<b>VPB7019</b> 950311	<b>T6025</b> 55010304	<b>T6025A</b> 55010399	
5911, 5945	Z5901	<b>VPB7019</b> 950311	<b>T6025</b> 55010304	<b>T6025A</b> 55010399	
6011, 6045	Z6001	<b>VPB7019</b> 950311	<b>T6025</b> 55010304	<b>T6025A</b> 55010399	
6211, 6245	Z6201	<b>VPB7019</b> 950311	<b>T6025</b> 55010304	<b>T6025A</b> 55010399	
6711, 6718 6745, 6748	Z6701	<b>VPB7019</b> 950311	<b>T6025</b> 55010304	<b>T6025A</b> 55010399	
6911, 6945	Z6901	<b>VPB7019</b> 950311	<b>T6025</b> 55010304	<b>T6025A</b> 55010399	
7011, 7045	Z7001	<b>VPB7019</b> 950311	<b>T6025</b> 55010304	<b>T6025A</b> 55010399	
7211, 7245	Z7201	<b>VPB7019</b> 950311	<b>T6025</b> 55010304	<b>T6025A</b> 55010399	
7711, 7745	Z7701	<b>VPB7019</b> 950311	<b>T6025</b> 55010304	<b>T6025A</b> 55010399	
8011, 8045 385, 385A	Z8001	<b>VPB7018</b> 80003046	<b>T6026</b> 80003033	<b>T6026A</b> 80003028	<b>T6026B</b> 80003008
10111, 10145, 1032 1034, 1132, 1134	Z8002.1	<b>VPB7018</b> 80003046	<b>T6026</b> 80003033	<b>T6026A</b> 80003028	<b>T6026B</b> 80003008

11.08





VPB7018



T6026

TRAKTORI-MALLI	MOOTTORI-TYYPPI	KIERTO-KANGEN HELA	KK-LAAKERIPARI		
			STD	-0,25 mm	-0,50 mm
<b>4 sylinteriset jatkuu</b>					
10111, 10145, 1032 1034, 1132, 1134	Z8002.134	<b>VPB7018</b> 80003046	<b>T6026</b> 80003033	<b>T6026A</b> 80003028	<b>T6026B</b> 80003008
8111, 8145 932, 934, 912, 914 914DL, 914 DL Turbo	Z8401.1	<b>VPB7018</b> 80003046	<b>T6026</b> 80003033	<b>T6026A</b> 80003028	<b>T6026B</b> 80003008
8111, 8145 932, 934, 914DL 914DL Turbo	Z8401.134	<b>VPB7018</b> 80003046	<b>T6026</b> 80003033	<b>T6026A</b> 80003028	<b>T6026B</b> 80003008
<b>6 sylinteriset</b>					
12011, 12045 1201, 1204	Z8601	<b>VPB7018</b> 80003046	<b>T6026</b> 80003033	<b>T6026A</b> 80003028	<b>T6026B</b> 80003008
16145 1434, 1634	Z8602.1	<b>VPB7018</b> 80003046	<b>T6026</b> 80003033	<b>T6026A</b> 80003028	<b>T6026B</b> 80003008
12111, 12145 1232, 1234, 1222, 1224	Z8701.1	<b>VPB7018</b> 80003046	<b>T6026</b> 80003033	<b>T6026A</b> 80003028	<b>T6026B</b> 80003000

25.07.2008

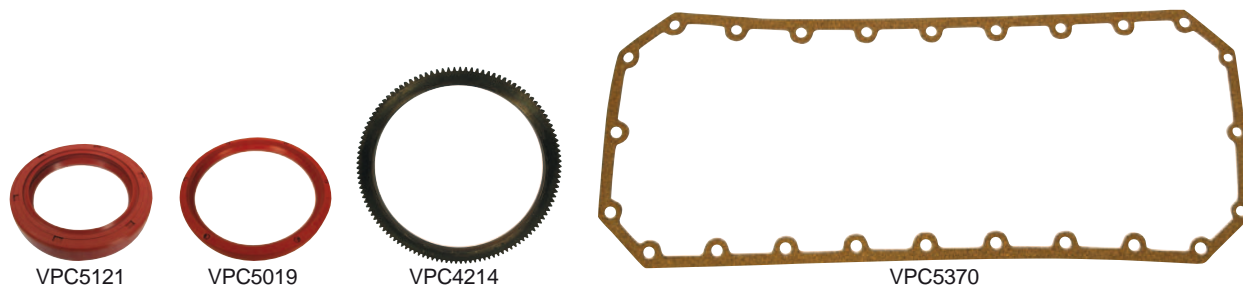

TRAKTORI-MALLI	MOOTTORI-TYYPPI	JAKOPÄÄN HUULI-TIIVISTE	KAMPI-AKSELIN TAKA-TIIVISTE	STARTTI-KEHÄ	ÖLJY-POHJAN TIIVISTE
2 sylinteriset 2511	Z2001	(b)	(c)	VPC4214 69010286	
3 sylinteriset 3011, 3045	Z3001	(b)	VPC5019 (c, f) 55010221	VPC4214 950316	
3511, 3545 3513	Z3001	(b)	VPC5019 (c, f) 55010221	VPC4214 950316	
4712, 4718	Z4701	VPC5121 (e) 974240	VPC5019 (l) 55010221	VPC4214 950316	VPC5369 47010244
4911	Z4901	VPC5121 (e) 974240	VPC5019 (l) 55010221	VPC4214 950316	VPC5369 47010244
5011	Z5001	VPC5121 (e) 974240	VPC5019 (l) 55010221	VPC4214 950316	VPC5369 47010244
5211, 5245	Z5201	VPC5121 (e) 974240	VPC5019 (l) 55010221	VPC4214 950316	VPC5369 47010244
4 sylinteriset 4511, 4611	Z4001	(b)	VPC5019 (c, f) 55010221	VPC4214 950316	
5711, 5718 5745, 5748	Z5501	VPC5121 (e, h) 974240	VPC5019 (l) 55010221	VPC4214 950316	VPC5370 55010202
5511, 5545 5516, 5611 5645, 5647	Z5501		VPC5019 (c, f) 55010221	VPC4214 950316	VPC5370 55010202
5911, 5945	Z5901	VPC5121 (e) 974240	VPC5019 (l) 55010221	VPC4214 950316	VPC5370 55010246
6011, 6045	Z6001	VPC5121 (e) 974240	VPC5019 (l) 55010221	VPC4214 950316	VPC5370 55010246
6211, 6245	Z6201	VPC5121 (e) 974240	VPC5019 (l) 55010221	VPC4214 950316	VPC5370 55010246
6711, 6718 6745, 6748	Z6701	VPC5121 (e, k) 974240	VPC5019 (l) 55010221	VPC4214 950316	VPC5370 55010202
6911, 6945	Z6901	VPC5121 (e) 974240	VPC5019 (l) 55010221	VPC4214 950316	VPC5370 55010246
7011, 7045	Z7001	VPC5121 (e) 974240	VPC5019 (l) 55010221	VPC4214 950316	VPC5370 55010246
7211, 7245	Z7201	VPC5121 (e) 974240	VPC5019 (l) 55010221	VPC4214 950316	VPC5370 55010246

Katso huomautukset sivulta I1.11

25.07.2008

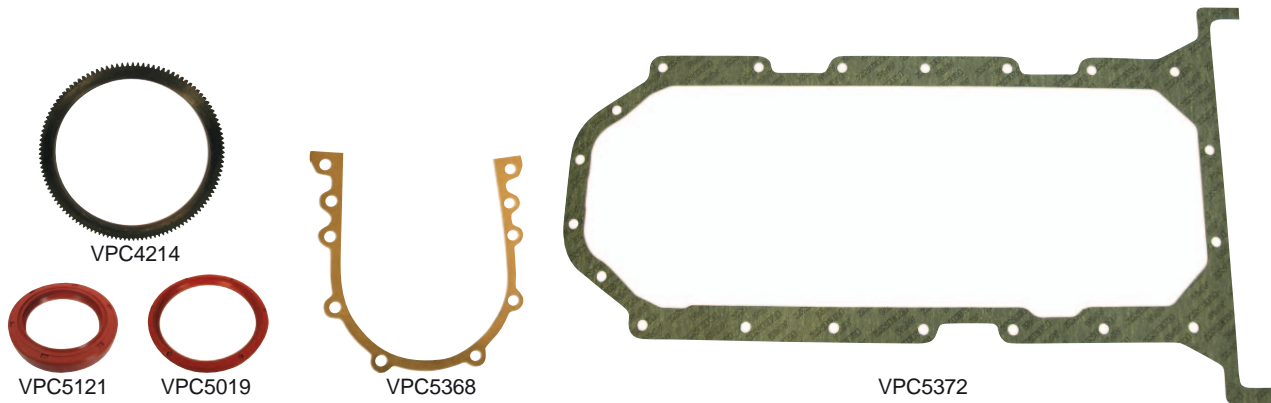

TRAKTORI-MALLI	MOOTTORI-TYYPPI	JAKOPÄÄN HUULI-TIIVISTE	KAMPI-AKSELIN TAKA-TIIVISTE	TAKA-LAIKAN TIIVISTE	STARTTI-KEHÄ	ÖLJY-POHJAN TIIVISTE
7711, 7745	Z7701	VPC5121 (e) 974240	VPC5019 (l) 55010221		VPC4214 950316	VPC5370 67010246
8011, 8045 385, 385A	Z8001	VPC5121 (n) 974240	VPC5018 (g) 86002901	VPC5368 80002081		VPC5372 80002083
10111, 10145 1032, 1034 1132, 1134	Z8002.1	VPC5121 (n) 974240	VPC5018 78002006	VPC5368 80002081		VPC5372 80002119
10111, 10145 1032, 1034 1132, 1134	Z8002.134	VPC5121 (n) 974240	VPC5018 78002006	VPC5368 80002081		VPC5372 80002119
8111, 8145 932, 934 912, 914 914DL, 914DL turbo	Z8401.1	VPC5121 (n) 974240	VPC5018 78002006	VPC5368 80002081		VPC5372 80002119
8111, 8145 932, 934 914DL 914DL turbo	Z8401.134	VPC5121 (n) 974240	VPC5018 78002006	VPC5368 80002081		VPC5372 80002119
6 sylinteriset 12011, 12045 1201, 1204	Z8601	VPC5121 (n) 974240	VPC5018 86002901	VPC5368 80002081		VPC5373 80002002
16145 1434, 1634	Z8602.1	VPC5121 (n) 974240	VPC5018 78002006	VPC5368 80002081		VPC5373 80002002
12111, 12145 1232, 1234 1222, 1224	Z8701.1	VPC5121 (n) 974240	VPC5018 78002006	VPC5368 80002081		VPC5373 80002002

b, c öljynheittorenkaalla

e - 52 x 72 x 12

f - vain vanhemman mallisiin moottoreihin

g - 1081 → 54488

h - 54489→

j - 1001→19983

k - 19984→

l - normaali-tyyppi

n - kaksoishuulitiiviste

q - huulitiiviste 8/78→

02.03.2007



VPA4113

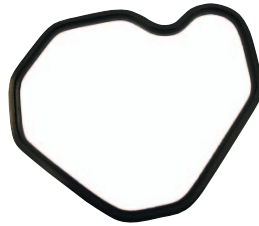

VPA4532

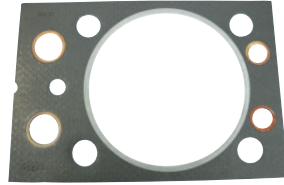

VPA4338



VPC4621

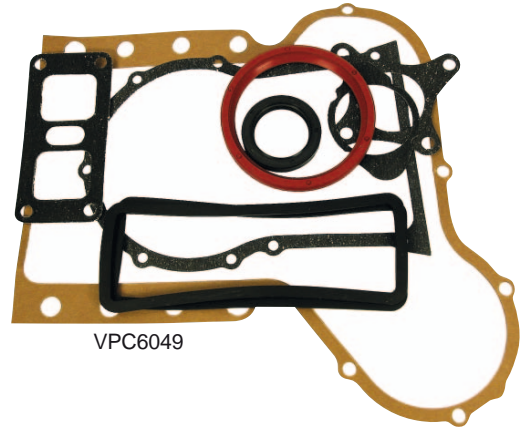

VPC6049

TRAKTORI-MALLI	MOOTTORI-TYYPPI	YLÄ-TIIVISTE-SARJA (a)	KANSI-TIIVISTE 1,2 mm	KANSI-TIIVISTE 1,5 mm	VENTTIILI-KANNEN TIIVISTE	ALA-TIIVISTE-SARJA	PAKKAS-TULPPA
<b>2 sylinteriset</b> 2511	<b>Z2001</b>	VPA4113 (d)	VPA4337 (b) 55010516		VPA4532 (d) 55010527		VPC4621 (c) 972311
<b>3 sylinteriset</b> 3011, 3045	<b>Z3001</b>	VPA4113 (e)	VPA4337 (b) 55010516		VPA4532 (e) 55010527	VPC6044 (j)	VPC4621 (c) 972311
<b>3511, 3545</b> <b>3513</b>	<b>Z3001</b>	VPA4113 (e)	VPA4337 (b) 55010516		VPA4532 (e) 55010527	VPC6044 (j)	VPC4621 (c) 972311
<b>4712, 4718</b>	<b>Z4701</b>	VPA4113 (e)	VPA4338 (b) 69010571	VPA4339 (b) 69010572	VPA4532 (e) 55010527		VPC4621 (c) 972311
<b>4911</b>	<b>Z4901</b>	VPA4113 (e)	VPA4338 (b) 69010571	VPA4339 (b) 69010572	VPA4532 (e) 55010527		VPC4621 (c) 972311
<b>5011</b>	<b>Z5001</b>	VPA4113 (e)	VPA4338 (b) 69010571	VPA4339 (b) 69010572	VPA4532 (e) 55010527		VPC4621 (c) 972311
<b>5211, 5245</b>	<b>Z5201</b>	VPA4113 (e)	VPA4338 (b) 69010571	VPA4339 (b) 69010572	VPA4532 (e) 55010527		VPC4621 (c) 972311
<b>4 sylinteriset</b> 4511, 4611	<b>Z4001</b>	VPA4113 (f)	VPA4337 (b) 55010516		VPA4532 (f) 55010527		VPC4621 (c) 972311
<b>5711, 5718</b> <b>5745, 5748</b>	<b>Z5501</b>	VPA4113 (f)	VPA4337 (b) 55010516		VPA4532 (f) 55010527		VPC4621 (c) 972311
<b>5511, 5545</b> <b>5516, 5611</b> <b>5645, 5647</b>	<b>Z5501</b>	VPA4113 (f)	VPA4337 (b) 55010516		VPA4532 (f) 55010527		VPC4621 (c) 972311
<b>5911, 5945</b>	<b>Z5901</b>	VPA4113 (f)	VPA4338 (b) 69010571	VPA4339 (b) 69010572	VPA4532 (f) 55010527	VPC6049	VPC4621 (c) 972311
<b>6011, 6045</b>	<b>Z6001</b>	VPA4113 (f)	VPA4338 (b) 69010571	VPA4339 (b) 69010572	VPA4532 (f) 55010527	VPC6049	VPC4621 (c) 972311
<b>6211, 6245</b>	<b>Z6201</b>	VPA4113 (f)	VPA4338 (b) 69010571	VPA4339 (b) 69010572	VPA4532 (f) 55010527	VPC6049	VPC4621 (c) 972311
<b>6711, 6718</b> <b>6745, 6748</b>	<b>Z6701</b>	VPA4113 (f)	VPA4338 (b) 69010571	VPA4339 (b) 69010572	VPA4532 (f) 55010527	VPC6049	VPC4621 (c) 972311
<b>6911, 6945</b>	<b>Z6901</b>	VPA4113 (f)	VPA4338 (b) 69010571	VPA4339 (b) 69010572	VPA4532 (f) 55010527	VPC6049	VPC4621 (c) 972311
<b>7011, 7045</b>	<b>Z7001</b>	VPA4113 (f)	VPA4338 (b) 69010571	VPA4339 (b) 69010572	VPA4532 (f) 55010527	VPC6049	VPC4621 (c) 972311
<b>7211, 7245</b>	<b>Z7201</b>	VPA4113 (f)	VPA4338 (b) 69010571	VPA4339 (b) 69010572	VPA4532 (f) 55010527	VPC6049	VPC4621 (c) 972311
<b>7711, 7745</b>	<b>Z7701</b>	VPA4113 (f)	VPA4338 (b,g) 69010571	VPA4339 (b,g) 69010572 VPA4348 (b,h)	VPA4532 (f) 55010527	VPC6049 (l)	VPC4621 (c) 972311

a - ei sisällä kansi- eikä termostaattikotelon tiivisteitä  
b - männän ylitys enintään 0,5 mm → kansitiiviste 1,2 mm  
i - männän ylitys yli 0,5 mm → kansitiiviste 1,5 mm  
c - Ø 30 mm  
d - 2 kpl/traktori  
e - 3 kpl/traktori  
f - 4 kpl/traktori

g - turbottomiin koneisiin  
h - turbollisiin koneisiin  
j - ei sisällä huulitiivisteitä  
k - sisältää tiivisteet ohjaustehostettuihin malleihin  
l - sisältää turbon kiinnitystiivisteiden  
m - sisältää tasapyörästökoneiston o-renkaat

25.07.2008

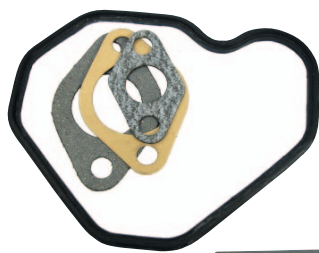

VPA4113

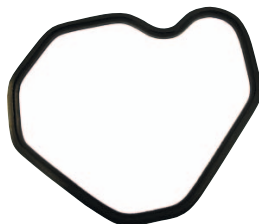

VPA4532

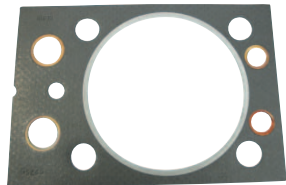

VPA4338



VPC4621

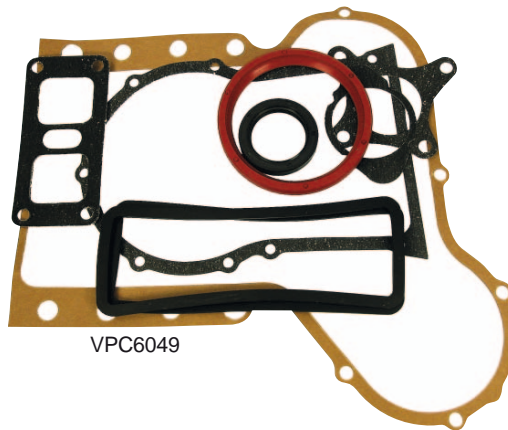

VPC6049

TRAKTORI-MALLI	MOOTTORI-TYYPPI	YLÄ-TIIVISTE-SARJA (a)	KANSI-TIIVISTE 1,2 mm	KANSI-TIIVISTE 1,5 mm	VENTTIILI-KANNEN TIIVISTE	ALA-TIIVISTE-SARJA	PAKKASTULPPA
4 sylinteriset 8011, 8045 385, 385A	Z8001	VPA4114	VPA4340 (b) 83005904	VPA4341 (i) 83005906	VPA4533 80005071	VPC6050	VPC4621 (c) 972311
10111, 10145 1032, 1034, 1132, 1134	Z8002.1	VPA4115 (l)	VPA4342 (b) 83005920	VPA4343 (i) 83005921	VPA4533 80005071	VPC6050	VPC4621 (c) 972311
10111, 10145 1032, 1034, 1132, 1134	Z8002.134	VPA4115 (l)	VPA4342 (b) 83005920	VPA4343 (i) 83005921	VPA4533 80005071	VPC6050 (m)	VPC4621 (c) 972311
8111, 8145 932, 934, 912, 914, 914 DL, 914DL Turbo	Z8401.1	VPA4115	VPA4342 (b) 83005920	VPA4343 (i) 83005921	VPA4533 80005071	VPC6050	VPC4621 (c) 972311
8111, 8145 932, 934, 914 DL, 914DL turbo	Z8401.134	VPA4115	VPA4342 (b) 83005920	VPA4343 (i) 83005921	VPA4533 80005071	VPC6050 (m)	VPC4621 (c) 972311
6 sylinteriset 12011, 12045 1201, 1204	Z8601						VPC4621 (c) 972311
16145 1434, 1634	Z8602.1	VPA4117 (l)	VPA4346 (b) 89005920	VPA4347 (i) 83005921			VPC4621 (c) 972311
12111, 12145 1232, 1234, 1222, 1224	Z8701,1	VPA4117	VPA4346 (b) 89005920	VPA4347 (i) 83005921			VPC4621 (c) 972311

- a - ei sisällä kansi- eikä termostaattikotelon tiivisteitä  
b - männän ylitys enintään 0,35 mm → kansi tiiviste 1,2 mm  
i - männän ylitys yli 0,35 mm → kansi tiiviste 1,5 mm  
c - Ø 30 mm  
j - ei sisällä huulitiivisteitä  
l - sisältää turbon kiinnitystiivisteiden  
m - sisältää tasapyörästökoneiston o-renkaat

## Huom.

Vuoden 1986 jälkeen valmistetuissa moottoreissa alkuperäisen kannentiivisteiden vahvuus ilmoitetaan moottorin tyyppikilvessä

## KANSITIIVISTEMALLIT

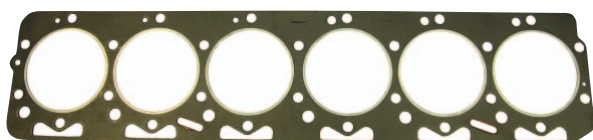

VPA4346 1,2 mm VPA4347 1,5 mm



VPA4342 1,2 mm VPA4343 1,5 mm

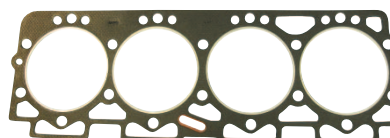

VPA4340 1,2 mm VPA4341 1,5 mm

08.01.2007



KUVA	NIMIKE	TUOTENUMERO	SOVELTUVUUDET
1	<b>SIIRTOPUMPPU</b> - 3-pulttinen kiinnitys	<b>VPD3034</b> 933201	2011, 2511, 3011, 3045, 3511, 3513, 3545, 4011, 4511, 4611, 4712, 4718, 4911, 5011, 5511, 5545, 5516, 5611, 5645, 5647, 5711, 5718, 5745, 5748, 5911, 5945, 6011, 6045, 6711, 6718, 6745, 6748, 6911, 6945, 7011, 7045
2	<b>SIIRTOPUMPPU</b> - 2-pulttinen kiinnitys	<b>VPD3032</b> 933272 933290 93009200 93009701	385, 385A, 912, 914, 914DL, 914DL TURBO, 932, 934, 1032, 1034, 1132, 1134, 1201, 1204, 1222, 1224, 1232, 1234, 1434, 1634, 3320, 3321, 3340, 3341, 4320, 4321, 4340, 4341, 5211, 5245, 5320, 5321, 5340, 5340H, 5341, 6211, 6245, 6320, 6321, 6340, 6341, 6911, 6945, 7211, 7245, 7245H, 7320, 7321, 7340, 7341, 7711, 7745, 8011, 8045, 8111, 8145, 8211, 8245, 9111, 9145, 9211, 9245, 10011, 10045, 10111, 10145, 10211, 10245, 11211, 11245, 12011, 12045, 12111, 12145, 12211, 12245, 14145, 14245, 16045, 16145, 16245
3	<b>KÄSIPUMPPU</b>	<b>VPD3299</b> 93009209 930616 933260	Samat kuin yllä olevissa pumpuissa VPD3034, VPD3032
4	<b>POLTTOAINEHANA</b>	<b>VPD4023</b> 955211	2511, 3011, 3045, 3511, 3545, 3513, 4712, 4718, 4911, 4511, 4611, 5711, 5718, 5745, 5748, 5511, 5545, 5516, 5611, 5645, 5647, 5911, 5945, 6711, 6718, 6745, 6748, 6911, 6945
5	<b>POLTTOAINETANKIN KUMIKANNATIN</b> - kierre M8	<b>VPD4506</b> 55115205 67115205	385, 385A, 1201, 12011, 12045, 1204, 2511, 3320, 3321, 3340, 3341, 3511, 3513, 3545, 4320, 4321, 4340, 4341, 4511, 4611, 4712, 4718, 4911, 5011, 5211, 5245, 5320, 5321, 5340, 5341, 5511, 5516, 5545, 5611, 5645, 5647, 5711, 5718, 5745, 5748, 5911, 5945, 6011, 6045, 6211, 6245, 6320, 6321, 6340, 6341, 6711, 6718, 6745, 6748, 6911, 6945, 7011, 7045, 7211, 7245, 7245H, 7320, 7321, 7340, 7341, 7711, 7745, 8011, 8045
5	<b>POLTTOAINETANKIN KUMIKANNATIN</b> - kierre M10	<b>VPD4507</b> 80311380	912, 914, 914DL, 914DL TURBO, 932, 934, 1032, 1034, 1132, 1134, 1201, 1204, 1222, 1224, 1232, 1234, 1434, 1634, 8011, 8045, 8111, 8145, 8211, 8245, 9111, 9145, 9211, 9245, 10011, 10045, 10111, 10145, 10211, 10245, 12011, 12045, 12111, 12145, 12211, 12245, 14145, 14245, 16045, 16145, 16245

08.01.2007



## 7 hyvää syytä vaihtaa uudet suutinkärjet

1. säästät polttoainetta
2. pidempi moottorin käyttöikä
3. puhtaammat päästöt
4. lisää tehoa
5. enemmän vääntöä
6. parempi käynnistyvyys
7. tasaisempi käynti



SD74017

NIMIKE	TUOTENUMERO	SOVELTUVUUDET
SUUTINKÄRKI	<b>SD74011</b> DOP150S525-1402	10111, 10145, 1032, 1034, 1132, 1134 (Z8002.1), 12011, 12045, 1201, 1204 (Z8601), 16145, 1434, 1634 (Z8602.1), 12111, 12145, 1232, 1234, 1222, 1224 (Z8701.1), 8011, 8045, 385, 385A (Z8001), 10111, 10145, 1032, 1034, 1132, 1134 (Z8002.134), 8111, 8145, 932, 934, 914DL, 914DL TURBO (Z8401.1, Z8401.134), 912, 914 (Z8401.1), 2511, 3511, 4511, 5511, 5545, 5611, 5645, 5647, 4712, 4718, 5711, 5718, 5745, 5748, 2011, 3011, 4011, 10011, 10045, 16045
SUUTINKÄRKI	<b>SD74017</b> DOP1605625-4343	3011, 3045, 3511, 3545, 3513 (Z3001), 4712, 4718 (Z4701), 4511, 4611 (Z4001), 5711, 5718, 5745, 5748 (Z5501), 4911 (Z4901), 5011 (Z5001), 5211, 5245 (Z5201), 5511, 5545, 5516, 5611, 5645, 5647 (Z5501), 5911, 5945 (Z5901), 6011, 6045 (Z6001), 6211, 6245 (Z6201), 6711, 6718, 6745, 6748, 6911, 6945 (Z6701), 7011, 7045 (Z7001), 7211, 7245 (Z7201), 7711, 7745 (Z7701), 2011, 2511, 3321, 3341, 4011, 4321, 4341, 5321, 5341, 6321, 6341, 7321, 7341
SUUTINKÄRKI	<b>SD740155</b> DOP150S535-1417	CRYSTAL UR2 TURBO, URSUS TURBO, 8011, 8045, 8111, 8145, 10111, 10145, 12011, 12045, 12111, 12145, 16145, 3320, 3321, 3340, 3341, 4320, 4321, 4340, 4341, 4911, 5011, 5211, 5245, 5320, 5340, 5340H, 5911, 5945, 6011, 6045, 6211, 6245, 6320, 6321, 6340, 6341, 6911, 6945, 7011, 7045, 7045H, 7211, 7245, 7245H, 7320, 7321, 7340, 7341, 7711, 7711T, 7745, 7745T, 8211, 8245, 9111, 9145, 9211, 9245, 10011, 10045, 10211, 10245, 11211, 11245, 12211, 12245, 14145, 14245, 16045, 16245

25.07.2008



TRAKTORI-MALLI	MOOTTORI-TYYPPI	VESI-PUMPPU SIIVALLA	VESI-PUMPPU ILMAN SIIVAA	VESI-PUMPPUN KORJAUS-SARJA	TUULETTAJAN HIHNA	TERMOS-TAATTI
2 sylinteriset 2511	Z2001	VPE1040 (k) 30010697		VPE2047 (c)	AVX17-1200 974312	
3 sylinteriset 3011, 3045	Z3001	VPE1040 (k, l) 30010697		VPE2047 (c)		
3511, 3545 3513	Z3001	VPE1040 (k) 30010697		VPE2047 (c)	AVX17-1200 974312	
4712, 4718	Z4701	VPE1040 (k) 30010697		VPE2047 (c)	AVX17-1200 974312	
4911	Z4901	VPE1043 (k) 69010651		VPE2047 (c)	AVX17-1200 974312	VPE3416 69011348
5011	Z5001	VPE1043 (a, k) 69010651 VPE1044 (b, k) 69010656	VPE1042 (b) 62010615	VPE2047 (c) VPE2046 (b, d) VPE2048 (b, e)	AVX17-1200 974312	VPE3416 69011348 70011316
5211, 5245	Z5201	VPE1044 (k) 69010656	VPE1042 62010615	VPE2047 (c) VPE2046 (d) VPE2048 (e)	AVX17-1200 974312	VPE3416 70011316
4 sylinteriset 4511, 4611	Z4001	VPE1040 (k) 30010697		VPE2047 (c)	AVX17-1200 974312	
5711, 5718 5745, 5748	Z5501	VPE1041 (k) 55010697		VPE2047 (c)	AVX17-1200 974312	VPE3416 69011348
5511, 5545 5516, 5611 5645, 5647	Z5501	VPE1041 (k) 55010697		VPE2047 (c)	AVX17-1200 974312	VPE3416 69011348
5911, 5945	Z5901	VPE1043 (k) 69010651		VPE2047 (c)	AVX17-1200 974312	VPE3416 69011348
6011, 6045	Z6001	VPE1043 (f, k) 69010651 VPE1044 (g, k) 69010656	VPE1042 (g) 62010615	VPE2047 (c) VPE2046 (g, d) VPE2048 (g, e)	AVX17-1200 974312	VPE3416 69011348 70011316
6211, 6245	Z6201	VPE1044 (k) 69010656	VPE1042 62010615	VPE2047 (c) VPE2046 (d) VPE2048 (e)	AVX17-1200 974312	VPE3416 70011316
6711, 6718 6745, 6748	Z6701	VPE1041 (k) 55010697		VPE2047 (c)	AVX17-1200 974312	VPE3416 69011348
6911, 6945	Z6901	VPE1043 (k) 69010651		VPE2047 (c)	AVX17-1200 974312	VPE3416 69011348
7011, 7045	Z7001	VPE1043 (h, k) 69010651 VPE1044 (j, k) 69010656	VPE1042 (j) 62010615	VPE2047 (c) VPE2046 (d, j) VPE2048 (e, j)	AVX17-1200 974312	VPE3416 70011316

Katso huomautukset sivulta I1.17

**I1.16**

Alkuperäisnumerot ovat ainoastaan vertailua varten, eivätkä tarkoita, että tuotteet ovat alkuperäisiä. Taulukoissa esiintyvät kuvat ovat viitteellisiä.



25.07.2008



VPE1044



VPE1042



VPE2047



VPE6067

AVX17-1200



VPE3416

TRAKTORI-MALLI	MOOTTORI-TYYPPI	VESI-PUMPPU SIIVALLA	VESI-PUMPPU ILMAN SIIVAA	VESI-PUMPUN KORJAUS-SARJA	KOMPRES-SORIN HIIHNA	TUULET-TAJAN HIIHNA	TERMOS-TAATTI
4 sylinteriset jatkuu 7211, 7245	Z7201	VPE1044 (k) 69010656	VPE1042 62010615	VPE2047 (c) VPE2046 (d) VPE2048 (c)		AVX17-1200 974312	VPE3416 70011316
7711, 7745	Z7701		VPE1042 (p) 62010615	VPE2046 (d) VPE2048 (e)		AVX17-1200 974312	VPE3416 70011316
8011, 8045 385, 385A	Z8001				VPE6067 (n)	VPE6069 80013903	VPE3416 80005902
10111, 10145 1032, 1034 1132, 1134	Z8002.1				VPE6067 (n)	VPE6069 (m) 80013903	VPE3416 80005904
10111, 10145 1032, 1034 1132, 1134	Z8002.134				VPE6067 (n)	VPE6069 (m) 80013903	VPE3416 80005904
8111, 8145 932, 934, 912, 914 914DL, 914DL Turbo	Z8401.1				VPE6067 (n)	VPE6069 (m) 80013903	VPE3416 80005904
8111, 8145 932, 934, 914DL, 914DL Turbo	Z8401.134				VPE6067 (n)	VPE6069 (m) 80013903	VPE3416 80005904
6 sylinteriset 12011, 12045 1201, 1204	Z8601				VPE6067 (n)	VPE6069 (m) 80013903	VPE3416 80005902
16145 1434, 1634	Z8602.1				VPE6067 (n)	VPE6069 (m) 80013903	VPE3416 80005904
12111, 12145 1232, 1234 1222, 1224	Z8701.1				VPE6067 (n)	VPE6069 (m) 80013903	VPE3416 80005904

a - →Z5001, 10352

b - Z5001, 10353→

c - korjaussarja VPE1040, VPE1041, VPE1043, VPE1044, 55010697, 69010651, 30010697, 30010037, 40010021, 40010697, 49010651, 69010656, 69010653 pumppuihin

d - korjaussarja VPE1042, 62010615 vesipumppuun

e - korjaussarja 70010675 ja 70010695 vesipumppuihin

f - →Z6001, 8850, yksi letkulähtö

g - Z6001, 8851→, kaksi letkulähtöä

h - →Z7001, 18402, yksi letkulähtö

j - Z7001, 18403→, kaksi letkulähtöä

k - rasvanipalla

l - ei vanhempiin malleihin kaksoissiivalla

m - malleihin, jossa yksiurainen siivapyörä

n - kompressorilla 2 kpl/traktori

p - ei sovi uudempiin Turbo-malleihin



TRAKTORI-MALLI	MOOTTORI-TYYPPI	JÄÄHDYT-TÄJÄN KORKKI	YLÄ-VESI-LETKU	ALA-VESI-LETKU	VÄLI-LETKU	LETKU VESI-PUMPUUN
2 sylinteriset 2511	Z2001	T4030 (a) 972501	VPE4180 70011304	VPE4176 951306	VPE4183 951313	VPE4172 951312
3 sylinteriset 3011, 3045	Z3001	T4030 (a) 972501	VPE4180 70011304	VPE4176 951306	VPE4183 951313	VPE4172 951312
3511, 3545 3513	Z3001	T4030 (a) 972501	VPE4180 70011304	VPE4176 951306	VPE4183 951313	VPE4172 951312
4712, 4718	Z4701	T4030 972501	VPE4180 70011304	VPE4176 951306	VPE4183 951313	VPE4172 951312
4911	Z4901	T4030 972501	VPE4179 55011312	VPE4176 55011310		
5011	Z5001	T4030 972501	VPE4179 (b) 55011312 VPE4180 (c) 70011304	VPE4176 70011315	VPE4162 (c) 70011306	VPE4172 (c) 70011307
5211, 5245	Z5201	T4030 (n) 972501	VPE4180 70011304	VPE4176 72013210	VPE4162 70011306	VPE4172 70011307
4 sylinteriset 4511, 4611	Z4001	T4030 (a) 972501	VPE4180 70011304	VPE4176 951306	VPE4183 951313	VPE4172 951312
5711, 5718 5745, 5748	Z5501	T4030 972501	VPE4179 55011312	VPE4176 55011310		
5511, 5545 5516, 5611 5645, 5647	Z5501	T4030 972501	VPE4179 55011312	VPE4176 55011310		
5911, 5945	Z5901	T4030 972501	VPE4179 55011312	VPE4176 55011310		
6011, 6045	Z6001	T4030 972501	VPE4179 (d) 55011312 VPE4180 (e) 70011304	VPE4176 70011315	VPE4162 (e) 70011306	VPE4172 (e) 70011307
6211, 6245	Z6201	T4030 (n) 972501	VPE4180 70011304	VPE4176 72011310	VPE4162 70011306	VPE4172 70011307
6711, 6718 6745, 6748	Z6701	T4030 972501	VPE4179 55011312	VPE4176 55011310		
6911, 6945 6745, 6748	Z6901	T4030 972501	VPE4179 55011312	VPE4176 55011310		
7011, 7045	Z7001	T4030 972501	VPE4179 (f) 55011312 VPE4180 (g) 70011304	VPE4176 55011310	VPE4162 (g) 70011306	VPE4172 (g) 70011307
7211, 7245	Z7201	T4030 (n) 972501	VPE4180 70011304	VPE4176 72011310	VPE4162 70011306	VPE4172 70011307
7711, 7745	Z7701	T4030 (n) 972501	VPE4180 70011304	VPE4176 72011310	VPE4162 70011306	VPE4172 70011307

Katso huomautukset sivulta I1.19

25.07.2008



T4030

VPE4181

VPE4177

TRAKTORI-MALLI	MOOTTORI-TYYPPI	JÄÄHDYTTÄJÄN KORKKI	YLÄ-VESILETKU	ALA-VESILETKU	LETKU VESIPUMPPUUN
4 sylinteriset jatkuu 8011, 8045 385, 385A	Z8001	T4030 972501	VPE4181 (j) 80013004 VPE4182 (k) 86013023	VPE4177 (l) 80013011	VPE4173 (j, m) 80013005
10111, 10145 1032, 1034 1132, 1134	Z8002.1	T4030 972501	VPE4182 86013023		
10111, 10145 1032, 1034 1132, 1134	Z8002.134	T4030 972501	VPE4182 86013023		
8111, 8145 932, 934, 912, 914 914DL, 914DL Turbo	Z8401.1	T4030 972501	VPE4182 86013023	VPE4177 (l) 83013011	
8111, 8145 932, 934 914DL, 914DL Turbo	Z8401.134	T4030 972501	VPE4182 86013023	VPE4177 (l) 83013011	
6 sylinteriset 12011, 12045 1201, 1204	Z8601	T4030 972501	VPE4182 86013023		VPE4173 (j, m) 80013005
16145 1434, 1634	Z8602.1	T4030 972501	VPE4181 80013004		
12111, 12145 1232, 1234 1222, 1224	Z8701.1	T4030 972501	VPE4181 80013004		

a - mallit, joissa painekorkki

b - →Z5001, 10352

c - Z5001, 10353→

d - →Z6001, 8850

e - Z6001, 8851→

f - →Z7001, 18402

g - Z7001, 18403→

j - vanhemmat Crystal-mallit

k - uudemmat Crystal-mallit

l - ensimmäinen osa jäähdyttimeltä mutkaan

m - toinen osa mutkasta vesipumppuun

n - mallit Windhoff-jäähdyttimellä



# ZETOR, URSUS PAKOPUTKISTO JA OSAT



26.09.2011

TRAKTORI-MALLI	MOOTTORI-TYYPPI	PAKO-PUTKI	PAKO-PUTKEN TIIVISTE	PAKO-PUTKEN HATTU	PAKO-SARJAN TIIVISTE
2 sylinteriset 2511	Z2001	VPE8061 LP3068		VLD2051 (a) 959068	
3 sylinteriset 3011, 3045	Z3001	VPE8061 LP3068		VLD2051 (a) 959068	
3511, 3545 3513	Z3001	VPE8061 LP3068		VLD2051 (a) 959068	
4712, 4718	Z4701	VPE8061 LP3068		VLD2051 (a) 959068	
4911	Z4901	VPE8061 69011403		VLD2051 (a) 959068	
5011	Z5001	VPE8063 (f) 70011423	VPE3995 (g) 69011419 VPE3996 (h) 70011402	VLD2051 (a) 959068	
5211, 5245	Z5201	VPE8063 (f) 70011423	VPE3995 (g) 69011419 VPE3996 (h) 70011402	VLD2051 (a) 959068	
4 sylinteriset 4511, 4611	Z4001	VPE8061 LP3068		VLD2051 (a) 959068	
5711, 5718 5745, 5748	Z5501	VPE8061 LP3068		VLD2051 (a) 959068	
5511, 5545 5516, 5611 5645, 5647	Z5501	VPE8061 LP3068		VLD2051 (a) 959068	
5911, 5945	Z5901	VPE8061 69011403		VLD2051 (a) 959068	
6011, 6045	Z6001	VPE8063 (f) 70011423	VPE3995 (g) 69011419 VPE3996 (h) 70011402	VLD2057 (a) 70011430	
6211, 6245	Z6201	VPE8063 (f) 70011423	VPE3995 (g) 69011419 VPE3996 (f, h) 70011402	VLD2057 (a) 70011430	
6711, 6745 6718, 6748	Z6701	VPE8061 LP3068		VLD2051 (a) 959068	
6911, 6945	Z6901	VPE8061 69011403		VLD2051 (a) 959068	
7011, 7045	Z7001	VPE8063 (f) 70011423	VPE3995 (g) 69011419 VPE3996 (h) 70011402	VLD2057 (a) 70011430	
7211, 7245	Z7201	VPE8063 (f) 70011423	VPE3995 (g) 69011419 VPE3996 (h) 70011402	VLD2057 (a) 70011430	
7711, 7745	Z7701		VPE3995 (g, j) 69011419		
8011, 8045 385, 385A	Z8001	VPE8067 (l) 80014090	VPE3996 80005094	VLD2057 (a) 80014999	VPE3994 (d) 80005091
10111, 10145 1032, 1034 1132, 1134	Z8002.1			VLD2060 (a) 89014999	VPE3994 (d) 80005091
10111, 10145 1032, 1034 1132, 1134	Z8002.134			VLD2060 (a) 89014999	VPE3994 (d) 80005091
8111, 8145 932, 934, 912, 914 914DL, 914DL Turbo	Z8401.1			VLD2057 (a) 89014999	VPE3994 (d) 80005091
8111, 8145 932, 934 914DL, 914DL Turbo	Z8401.134			VLD2057 (a) 89014999	VPE3994 (d) 80005091
6 sylinteriset 12011, 12045 1201, 1204	Z8401.134	VPE8067 (l) 80014090	VPE3996 80005094	VLD2057 (a) 80014999	VPE3994 (e) 80005091
16145 1434, 1634	Z8602.1			VLD2060 (a) 89014999	VPE3994 (e) 80005091
12111, 12145 1232, 1234 1222, 1224	Z8701.1			VLD2057 (a) 80014999	VPE3994 (e) 80005091

Katso huomautukset ja pakoputkien mitat seuraavalta sivulta

11.20

Alkuperäisnumerot ovat ainoastaan vertailua varten, eivätkä tarkoituksenaan, että tuotteet ovat alkuperäisiä.  
Taulukoissa esiintyvät kuvat ovat viitteellisiä.



VLD2057

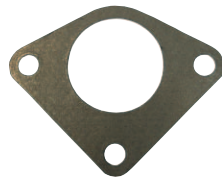

VPE3995



VLD2051

## Huomautukset edellisen sivun taulukkoon

- |                                  |  |
|----------------------------------|--|
| a - täydellinen                  | g - pakosarjan ja pakoputken mutkan välitiiviste     |
| b - käytä 2 kpl/traktori         | h - pakoputken mutkan laippatiiviste vaimentimelle   |
| c - käytä 3 kpl/traktori         | j - ei turbo-malleihin                               |
| d - käytä 4 kpl/traktori         | k - tiiviste 2:lla koukkupultilla var. vaimentimelle |
| e - käytä 6 kpl/traktori         | l - uudemmat mallit Crystal-moottorilla              |
| f - kolmen reiän laippakiinnitys | m - ei mallissa 5611                                 |



ST0202



T6079



VPF3221



VPF2515



ST0079



VPF2615

04.03.2011

TRAKTORI- MALLI	UUSI KORVAAVA STARTTI- MOOTTORI	VARAOSAT ALKUPERÄISSTARTTIIN			
		SOLENOIDI PAL	HIILI- SARJA	BENDIX- RATAS	VIRTA- LUKKO
2 sylinteriset 2511					<b>T6079</b> 55115731
3 sylinteriset 3011, 3045, 3511, 3545, 3513		<b>ST0079</b> 932301	<b>VPF2615</b> (a) 4 x 932233	<b>VPF2515</b> (a) 932208	<b>T6079</b> (f) 55115731
4712, 4718, 4911		<b>ST0079</b> 932301	<b>VPF2615</b> 4 x 932233	<b>VPF2515</b> 932208	<b>T6079</b> (f) 55115731
5011, 5211, 5245		<b>ST0079</b> 932301	<b>VPF2615</b> 4 x 932233	<b>VPF2515</b> 932208	<b>VPF3221</b> (g) 59115613
4 sylinteriset 4511, 4611		<b>ST0079</b> 932301	<b>VPF2615</b> (a) 4 x 932233	<b>VPF2515</b> (a) 932208	<b>T6079</b> (f) 55115731
5711, 5718, 5745, 5748, 5511, 5545, 5516, 5611, 5645, 5647, 6711, 6718 6745, 6748, 6911, 6945		<b>ST0079</b> 932301	<b>VPF2615</b> (c) 4 x 932233	<b>VPF2515</b> (c) 932208	<b>T6079</b> (f) 55115731
5911, 5945		<b>ST0079</b> 932301	<b>VPF2615</b> 4 x 932233	<b>VPF2515</b> 932208	<b>T6079</b> (f) 55115731
6011, 6045, 6211, 6245		<b>ST0079</b> 932301	<b>VPF2615</b> 4 x 932233	<b>VPF2515</b> 932208	<b>VPF3221</b> (g) 59115613
7011, 7045, 7211, 7245, 7711, 7745		<b>ST0079</b> 932301	<b>VPF2615</b> (c) 4 x 932233	<b>VPF2515</b> (c) 932208	<b>VPF3221</b> (g) 59115613
8011, 8045, 385, 902, 904	<b>ST0202</b> 80357918	<b>ST0079</b> 932301	<b>VPF2615</b> (e) 4 x 932233	<b>VPF2515</b> (e) 932208	<b>T6079</b> (f) 89355905
10111, 10145, 1032, 1034, 1132, 1134, 8111, 8145, 932, 934, 912, 914, 914DL, 914DL Turbo	<b>ST0202</b> 80357918	<b>ST0079</b> 932301	<b>VPF2615</b> 4 x 932233	<b>VPF2515</b> 932208	<b>T6079</b> (f) 89355905

a - sopii uudempaan 69185771 starttimoottoriin  
c - sopii 97611, 576117 tai 69185771 startteihin  
d - sopii 80357918 vanhempaan starttimoottoriin  
e - sopii 80357918 tai 976118 startteihin

f - lukossa asennot 0-1-2-3,  
suomalainen ohjaamo →1980  
g - lukossa asennot 0-1-2,  
valkokattoinen ohjaamo 1980→

## STARTTIMOOTTORI HD 230

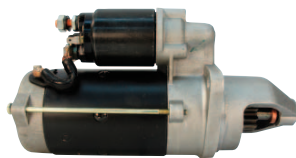

### SM2834A

- 3011, 3045, 3320, 3340, 3511, 3545, 3513, 4320, 4340  
4712, 4718, 4911, 5011, 5211, 5245, 4511, 4611, 5711,  
5718, 5745, 5748, 5511, 5545, 5516, 5611, 5645, 5647,  
5911, 5945, 6011, 6045, 6211, 6245, 6711, 6718, 6745,  
6748, 6911, 6945, 7011, 7045, 7211, 7245, 7711, 7745

## STARTTIMOOTTORI 24 V



### ST0203

- Zetor UR II 8211, 8245, 9211, 9245, 10211, 10245, 11211,  
11245, 12211, 12245, 14245, 16245, Zetor UR IV 8311,  
8345, 10311, 10345, 11311, 11345, 12311, 12345, 14345,  
16345, 18345, Ursus 1201, 1204, 1214, 1222, 1224, 1232,  
1233, 1234, 1235, 1252, 1254, 1252, 1354, 1435,  
1552, 1554, 1614, 1634, 1635, 1752, 1754  
- 6,5 kW

## STARTER HD

### ST35210

- Zetor 3011, 3045, 3511, 3545, 3513, 4712, 4718, 4911, 5011, 5211, 5245,  
4511, 4611, 5711, 5718, 5745, 5748, 5511, 5545, 5516, 5611, 5645, 5647,  
5911, 5945, 6011, 6045, 6211, 6245, 6711, 6718, 6745, 6748, 6911, 6945,  
7011, 7045, 7211, 7245, 7711, 7745

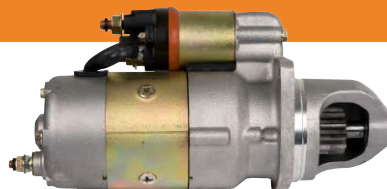

- 12 V  
- 4,0 kW  
- 11 hammasta  
- LRS 147

25.07.2008

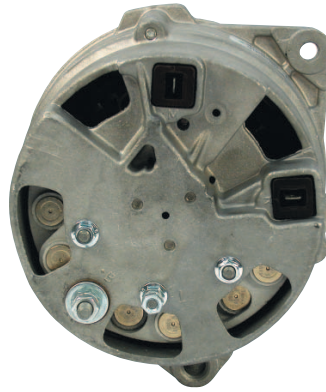

ST0217

VPF4120

TRAKTORI-MALLI	KORVAAVA LATURI SISÄÄNRAKENNETULLA JÄNNITESÄÄTIMELLÄ	ULKOPUOLINEN JÄNNITESÄÄDIN ALKUPERÄIS- LATURIIN
3 sylinteriset 4911 5011 5211, 5245	ST0217	VPF4120 (g) 86350903 59115782
4 sylinteriset 5911, 5945	ST0217	VPF4120 (g) 86350903
6011, 6045 6211, 6245 6911, 6945	ST0217	VPF4120 (g) 59115782 86350903
7011, 7045 7211, 7245 7711, 7745	ST0217	VPF4120 (g) 59115782
8011, 8045 8111, 8145	ST0217	VPF4120 (g) 86350903
10111, 10145	ST0217	VPF4120 86350903
6 sylinteriset 12011, 12045 16145 12111, 12145	ST0217	VPF4120 (g) 86350903

- g - käytetään 14 V 55 AMP laturissa,  
uudemmat mallit 443116419060 säätimellä  
- 443116419070 tyyppi säädin.

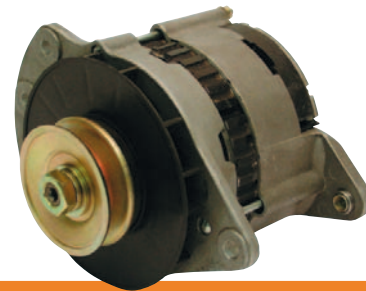

## LATURI 65 A

### ST0210

- sisältää tuulettimen ja hihnapyörän
- yleismalli vaatii sovituksen
- w-liitin

11.23

22.10.2010

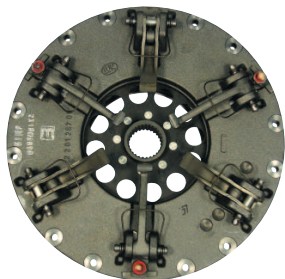

LUK231009810

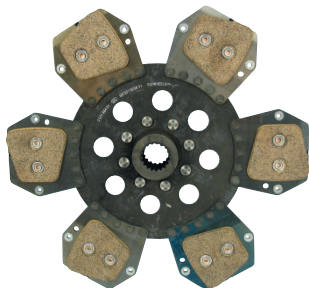

LUK331023011

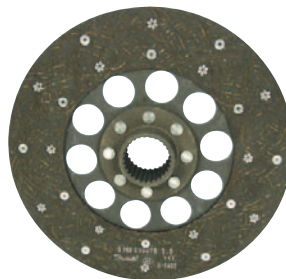

LUK328033310



T6080



L6304-2RS

TRAKTORI-MALLI	ASETELMA	AJO-KYTKIN-LEVY	VOIMAN ULOSOTON KYTKIN-LEVY	AJO-KYTKIN PAINE-LAAKERI	SILMÄ-LAAKERI
5011, 4011, 4511, 4712, 4911, 5211, 5245, 5511, 5545, 5711, 5718, 5745, 5748, 5911, 5945, 6011, 6045, 6211, 6245, 6711, 6718, 6745, 6748, 6911, 6945, 7011, 7045, 7211, 7245, 7711, 7745	LUK228013110 (c, 2) 280 mm	LUK328035610(a) T6055 LUK328035710 (b) T6056 keskiön mitat 18x28 mm	LUK328033310 T6082	T6083 65x102x26,5 ZR1175	L6304-2RS
3320, 3340, 4320, 4340, 5320, 5340, 5340h, 6320, 6340, 7320, 7320T, 7340, 7340T		LUK331023011 (a) T6154 keskiön mitat 18x28 mm	LUK328033310 T6082		L6304-2RS
8011, 7045, 7520, 7540, 8520T, 8540T, 9520, 9540, 10520T, 10540T, URSUS 385, 902, 904, 1201, 1204	LUK133024110 (3) 330 mm	LUK333014211 (a) T6057 LUK333014212 (b) T6058 keskiön mitat 18x30 mm		T6080 70x117x27 80108020	
10011, 10045, 12011, 12045, 1211, 14111, 14145, 16145, 8145, URSUS 902, 904, 912, 914, 1201, 1204	327 mm	LUK333005610 (a) T6059 keskiön mitat 22x35 mm		T6080 79x117x27 80108020	L6304-2RS
10111, 10145, 9111, 9145, 9211, 9245, 8145, URSUS 902, 904, 912, 914, 1214, 1224	350 mm	LUK335016710 (a) T6067 keskiön mitat 22x35 mm		T6080 70x117x27 80108020	L6304-2RS
11245, 12141, 12145, 12211, 12245, 14145, 14245, 16145, URSUS 1214, 1224	380 mm	LUK338015010 (a) T6068 keskiön mitat 22x35 mm		T6080 70x117x27 80108020	L6304-2RS

a - orgaani

c - ei sovi, jos vanhan asetelman käpälät ovat saman pituiset

b - keraaminen

2 - VO-levy

3 - ei levyä

## KYTKIMEN PÄÄSYLINTERI

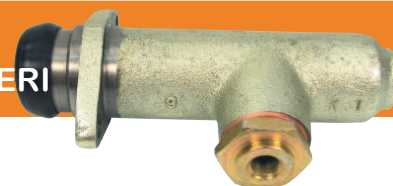

### VPJ7632

Z69112717

- sopii: 3320, 3340, 4320, 4340, 5011, 5213, 5243, 5211, 5245, 5320, 5340H, 6011, 6045, 6211, 6245, 6320, 6340, 7011, 7045, 7211, 7215, 7245H, 7320, 7340, 7711, 7745



LUK433008310

- painelevy + jousi 280 mm  
alkuperäiseen kytkimeen



LUK 434013310

- painelevy 310 mm  
alkuperäiseen kytkimeen

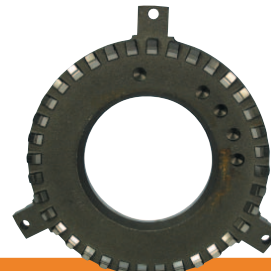

LUK434010810

- painelevy 280 mm  
alkuperäiseen kytkimeen



01.12.2009

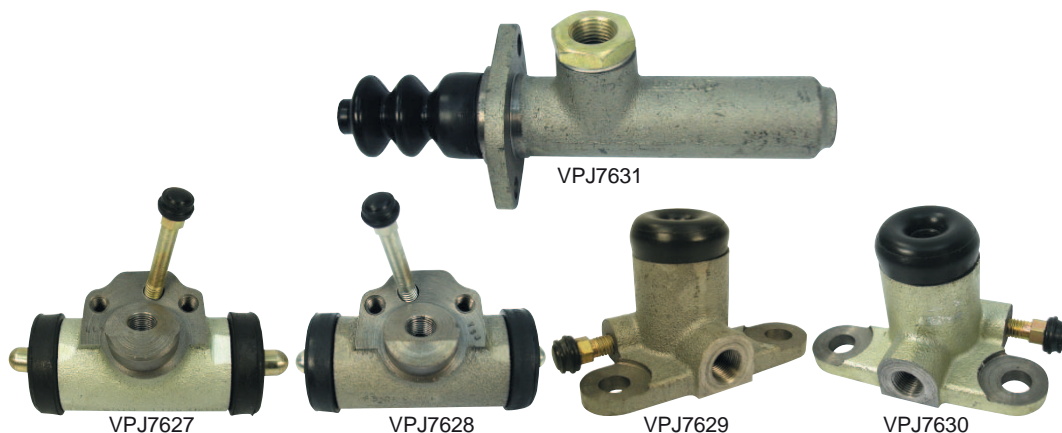

TRAKTORI-MALLI	JARRUN PÄÄ-SYLINTERI	PYÖRÄ-SYLINTERI VASEN RUMPU-JARRUT	PYÖRÄ-SYLINTERI OIKEA RUMPU-JARRUT	PYÖRÄ-SYLINTERI VASEN LEVY-JARRUT	PYÖRÄ-SYLINTERI OIKEA LEVY-JARRUT
ZETOR UR1-sarja 2011, 3011, 3045, 4011, 2511, 3511, 3513, 3545, 4511, 4611	VPJ7631 975032	VPJ7627 67112603	VPJ7628 67112604		
5511, 5616, 5611, 5545, 5645, 5647, 4712, 4718, 5711, 5718, 5745, 5748, 6711, 6718, 6745, 6748, 4911, 5911, 5945, 6911, 6945	VPJ7631(d) 975032	VPJ7627 67112603	VPJ7628 67112604		
5011, 6011, 6045, 7011, 7045, 7045H	VPJ7632(d) 69112717	VPJ7627 67112603	VPJ7628 67112604		
5211, 5245, 6211, 6245, 7211, 7245, 7245H	VPJ7632(d) 69112717	VPJ7627 67112603	VPJ7628 67112604	VPJ7630(a,b) 83227912	VPJ7629(a,b) 83227911
7711, 7745	VPJ7632(d) 69112717			VPJ7630 (b) 83227912	VPJ7629 (b) 83227911
Crystal UR2-sarja 8011, 8045, 8111, 8145 12011, 12045 Ursus 385, 1201, 1204 Ursus 912, 914, 932, 934	VPJ7631(d) 975032			VPJ7629 (b) 83227911	VPJ7630 (c) 83227912
9111, 9145, 10111, 10145, Ursus 1032, 1034, 1132, 1134, 12111, 12145, 14145, 16145, 1224, 1234, 1434, 1634	VPJ7631(d) 975032			VPJ7629 (b) 83227911	VPJ7630 (c) 83227912
8211, 8245, 9211, 9245 10211, 10245, 11211, 11245, 12211, 12245, 14245, 16245	VPJ7631(d) 86227903			VPJ7629 (b) 83227911	VPJ7630 (c) 83227912
10045, 16045, 3320, 3340, 4320, 4340, 5211, 5245, 5320, 5340, 5340H, 6211, 6245, 6320, 6340, 7211, 7245, 7245H, 7320, 7340, 7711, 7745, 8211, 8245, 9211, 9245				VPJ7629 (b) 83227911	VPJ7630 (c) 83227912

a - ei malleihin, joissa ilmajarrut  
b - Ø 22 mm, jarruputkien kiinnitys yläpuolelta

c - Ø 22 mm, jarruputkien kiinnitys alapuolelta  
d - oikea ja vasen

## JARRULEVYSARJA



### T6002

80227031

- Zetor 8011, 8045, 8111, 8145, 8211, 8245, 9111, 9145, 9211, 9245, 10011,  
10045, 10111, 10145, 10211, 10245, 11211, 11245, 12011, 12045, 12111,  
12145, 12211, 12245, 14145, 14245, 16045, 16145, 16245  
- URSUS 385, 902, 904, 912, 914, 1201, 1204, 1214, 1224

## JARRULEVY

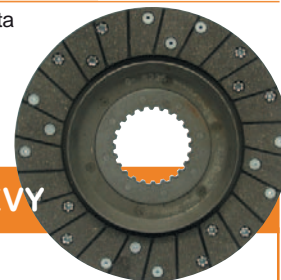

### T6081

80227010

- sopii: Zetor 3320, 3340, 4320, 4340,  
5211, 5245, 5320, 5340, 6211, 6245,  
6320, 6340, 7211, 7245, 7320, 7340,  
7711, 7745

11.25



VPJ3141



VPJ3150



VPJ3140



VPJ3142



VPJ3149



VPJ3145

VPJ3146

TRAKTORI-MALLI	SIVU-TANGON ETU-PÄÄ	SIVU-TANGON TAKA-PÄÄ	RAIDE-TANGON PÄÄ VASEN	RAIDE-TANGON PÄÄ OIKEA	RAIDE-TANGON PÄÄ ULOMPI LOVETTU	SYLINTERIN PÄÄ		
						RAIDE-TANGON PÄÄ SISEMPI KIERRE	ETU	TAKA
UR1-sarja, 2011, 3011, 4011	VPJ3138 (a) 953519	VPJ3139 (b) 953548						
2511, 3511, 4511, 4611	VPJ3138 (a) 953519	VPJ3139 (b) 953548						
3513	VPJ3138 (a) 953519	VPJ3139 (b) 953548	VPJ3138 (a) 953519	VPJ3139 (b) 953548				
5511, 5516, 5611	VPJ3141 (c) 67143531	VPJ3140 (d) 55113565	VPJ3141 (c) 67143531	VPJ3142 (d) 6714535			VPJ3146 (d,j) 55113915	VPJ3145 (d,j) 55113905
4712, 4718	VPJ3141 (c) 67143531	VPJ3140 (d) 55113565	VPJ3141 (c) 67143531	VPJ3142 (d) 6714535				
5711, 5718, 6711, 6718	VPJ3141 (c) 67143531	VPJ3140 (d) 55113565	VPJ3141 (c) 67143531	VPJ3142 (d) 67143535			VPJ3146 (d,j) 55113915	VPJ3145 (d,j) 55113905
4911, 5911, 6911	VPJ3141 (c) 67143531	VPJ3140 (d) 55113565	VPJ3141 (c) 67143531	VPJ3142 (d) 67143535			VPJ3146 (d,j) 55113915	VPJ3145 (d,j) 55113905
5011, 6011, 7011	VPJ3141 (c) 67143531	VPJ3140 (d) 55113565	VPJ3141 (c) 67143531	VPJ3142 (d) 67143535			VPJ3146 (d,j) 55113915	VPJ3145 (d,j) 55113905
5211, 6211, 7211	VPJ3141 (c) 67143531	VPJ3140 (d) 55113565	VPJ3141 (c) 67143531	VPJ3142 (d) 67143535			VPJ3146 (d,j) 55113915	VPJ3145 (d,j) 55113905
7711(k)	VPJ3141 (c) 67143531	VPJ3140 (d) 55113565	VPJ3141 (c) 67143531	VPJ3142 (d) 67143535			VPJ3146 (d,j) 55113915	VPJ3145 (d,j) 55113905
Crystal UR2-sarja 8011, Ursus 385					VPJ3150 (h,i) 80220029	VPJ3149 (e) 80220019		
12011 Ursus 1201					VPJ3150 (h,i) 80220029	VPJ3149 (e) 80220019		
8111, 9111 Ursus 912, 932					VPJ3150 (h) 80220029	VPJ3149 (e) 80220019		
10111, 12111 Ursus 1032, 1132					VPJ3150 (h) 80220029	VPJ3149 (e) 80220019		
8211, 9211					VPJ3150 (h) 80220029	VPJ3149 (e) 80220019		
10211, 11211 12211					VPJ3150 (h) 80220029	1VPJ3149 (e) 80220019		

- a - Ø 16 mm, vasenkätinen ulkokierre
- b - Ø 16 mm, oikeakätinen ulkokierre
- c - Ø 18 mm, vasenkätinen ulkokierre
- d - Ø 18 mm, oikeakätinen ulkokierre
- e - Ø 24 mm, oikeakätinen ulkokierre

- h - Ø 24 mm, varsi 8 uralla
- i - myöhempiin Crystal-malleihin
- j - vaihtoehtoinen
- k - ei malleihin, joissa hydrostaattinen ohjaus

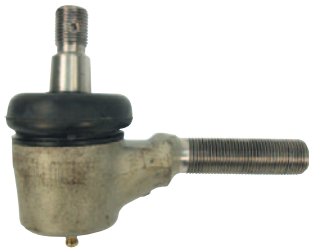

VPJ3147



VPJ3144



VPJ3145

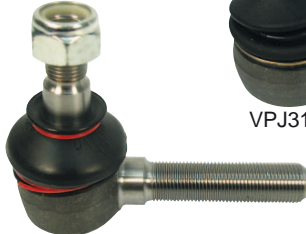

VPJ3148



VPJ3143

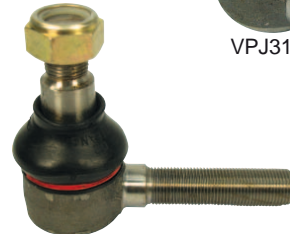

VPJ3151

TRAKTORI- MALLI	SIVU- TANGON ETU- PÄÄ	SIVU- TANGON TAKA- PÄÄ	RAIDE- TANGON PÄÄ		OHJAUSTEHOSTIMEN VARREN PÄÄ		SYLINTERIN PÄÄ	
			VASEN ULOMPI	OIKEA ULOMPI	ULOMPI	SISEMPI	ETU	TAKA
UR1-sarja, 3045, 3545	VPJ3138(a) 953519	VPJ3139(b) 953548	VPJ3138(a) 953519	VPJ3139(b) 953548				
5545, 5645, 5647 5745, 5748	VPJ3141(c) 67143531	VPJ3140(d) 55113565	VPJ3141(c) 67143531	VPJ3142(d) 67143535			VPJ3146(d,g) 5513915	VPJ3145(d,g) 55113905
6745, 6748, 5945, 5945, 6945, 6045, 7045	VPJ3147(c) 67453503	VPJ3148(d) 67453504	VPJ3143(e) 88221009	VPJ3144(f) 88221119			VPJ3151(d) 67453905	VPJ3145(d) 55113905
	VPJ3147(c) 67453504	VPJ3148(d) 67453504	VPJ3143(e) 88221009	VPJ3144(f) 88221119			VPJ3151(d) 67453905	VPJ3145(d) 55113905
5245		VPJ3148(d) 67453504	VPJ3143(e) 88221009	VPJ3144(f) 88221119			VPJ3151(d) 67453905	VPJ3145(d) 55113905
6245, 7245 7245H	VPJ3147(c) 67453503	VPJ3148(d) 67453504	VPJ3143(e) 88221009	VPJ3144(f) 88221119			VPJ3151(d) 67453905	VPJ3145(d) 55113905
7745H	VPJ3147(c) 67453503	VPJ3148(d) 67453504	VPJ3143(e) 88221009	VPJ3144(f) 88221119			VPJ3151(d) 67453905	VPJ3145(d) 55113905
Crystal UR2-sarja 8045, 12045, Ursus 385, 1204			VPJ3143(e) 88221009	VPJ3144(f) 88221119	VPJ3144(f) 88221119	VPJ3143(e) 88221009		
8145 (k), 9145 (k) 1986→ Ursus 914, 934			VPJ3143(e,j) 88221009	VPJ3144(f,j) 88221119	VPJ3144(f,j) 88221119	VPJ3143(e,j) 88221009		
10145 (k), 12145 (k) Ursus 1034, 1134, 1224, 1234			VPJ3143(e,j) 88221009	VPJ3144(f,j) 88221119	VPJ3144(f,j) 88221119	VPJ3143(e,j) 88221009		
Crystal UR2-sarja 14145 (k) 1986→ 16145 (k), 8245 (k), 9245 (k) Ursus 1634, 1434			VPJ3143(e,j) 88221009	VPJ3144(f,j) 88221119	VPJ3144(f,j) 88221119	VPJ3143(e,j) 88221009		
10245 (k), 11245 (k) 12245 (k), 14245 (k) 16245 (k)			VPJ3143(e,j) 88221009	VPJ3144(f,j) 88221119	VPJ3144(f,j) 88221119	VPJ3143(e,j) 88221009		

a - Ø 16 mm, vasenkätinen ulkokierre  
b - Ø 16 mm, oikeakätinen ulkokierre  
c - Ø 18 mm, vasenkätinen ulkokierre  
d - Ø 18 mm, oikeakätinen ulkokierre  
e - Ø 27 mm, vasenkätinen ulkokierre

f - Ø 27 mm, oikeakätinen ulkokierre  
g - vaihtoehtoinen  
j - normaaliilla nelivetoakselilla  
k - ei malleihin joissa hydraulinen nelivedon tasauspyörästäön lukko

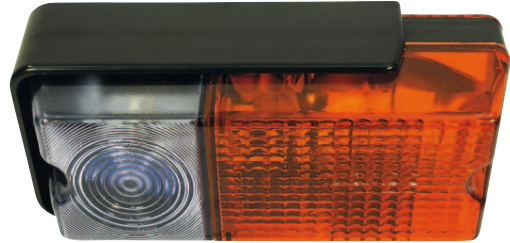
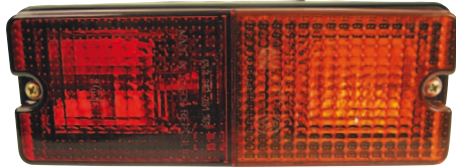

## TAKAVALO LYHTY

- 3320, 3340, 4320, 4340, 4712, 4718, 4911, 5011, 5211, 5245, 5320, 5340, 5711, 5718, 5745, 5748, 5911, 5945, 6011, 6045, 6211, 6245, 6320, 6340, 6711, 6718, 6911, 6945, 7011, 7045, 7211, 7245, 7711, 7745, 8011, 8045, 8111, 8145, 8211, 8245, 9111, 9145, 9211, 9245, 10011, 10045, 10111, 10145, 10211, 10245, 11211, 11245, 12011, 12045, 12111, 12145, 12211, 12245, 14145, 14245, 16045, 16145, 16245

- KÄYTTÄ EHDOTTOMASTI ALKUPERÄISET JOHDON LIITTIMET

**Vasen**

**T6145**

67115712

- varalasi **T6147**

**Oikea**

**T6144**

67115711

- varalasi **T6146**

## ÄÄRIVALO LYHTY etu

**T6148**

62115803

- 3320, 3340, 4320, 4340, 4712, 4718, 4911, 5011, 5211, 5245, 5320, 5340, 5711, 5718, 5745, 5748, 5911, 5945, 6011, 6045, 6211, 6245, 6320, 6340, 6711, 6718, 6911, 6945, 7011, 7045, 7211, 7245, 7711, 7745, 8011, 8045, 8111, 8145, 8211, 8245, 9111, 9145, 9211, 9245, 10011, 10045, 10111, 10145, 10211, 10245, 11211, 11245, 12011, 12045, 12111, 12145, 12211, 12245, 14145, 14245, 16045, 16145, 16245

- varalasi **T6149**



## ETU-UMPIO

- 7745, 8011, 8045, 8111, 8145, 8211, 8245, 9111, 9145, 9211, 9245, 10011, 10045, 10111, 10145, 10211, 10245, 11211, 11245, 12011, 12045, 12111, 12145, 12211, 12245, 14145, 14245, 16045, 16145, 16245

**Vasen**

**T6143**

89352904

**Oikea**

**T6142**

89352903

## ETU-UMPIO



**T6140**

931414

- 5011, 5211, 5245, 6011, 6045, 6211, 6245, 7011, 7045, 7211, 7245, 7711, 7745



## ETU-UMPIO

**T6141**

931425

- 3320, 3340, 4320, 4340, 5320, 5340, 6320, 6340



## TAKALASI

### T6100

- 5211, 5245, 6211, 6245, 7211, 7245, 7711, 7745, 3320, 3340, 4320, 4340, 5320, 5340, 6320, 6340, 7320, 7340
- hyttimalli BK7011, 7011M
- EI LÄMPÖVASTUSTA

## TAKALASI

### T6101

- 8111, 8145, 9145, 9245, 10145, 10245, 12145, 12245, 14145, 14245
- EI LÄMPÖVASTUSTA

## SIVULASI

### T6103

- 5211, 5245, 6211, 6245, 7211, 7245, 7711, 7745
- hyttimalli BK7011

## HYTIN KAASUSYLINTERIT



### T6084 KS0126

- 62117932
- pituus 320 mm
- oveen 150N
- reiät 8 mm (kuvassa)

### T6084A KS0127

- 62117932
- pituus 325 mm
- takalasiin 250N
- reiät 8 mm

### T6085 KS0128 VPM1673

- 60117921
- pituus 420 mm
- reiät 10 mm
- takalasi
- ovi

## TUNTIMITTARIN VAIJERIT

### VPM5226

- 3011, 3045, 3511, 3513, 3545, 4712, 4718, 4911
- pituus 1560 mm

### VPM5227

- 4511, 4611, 5511, 5545, 5611, 5645, 5647, 5711, 5718, 5745, 5748, 6711, 6718, 6745, 6748, 5911, 5945, 6911, 6945, 8011, 8045, 8111, - 8145, 9111, 9145, 10111, 10145
- pituus 1840 mm

### VPM5228

- 12011, 12045, 12111, 12145, 14145, 16145
- pituus 2090 mm



## LASINPYYHKIMEN SULAT

### VLC3221

- pituus 355 mm

### VLC3228

- pituus 510 mm



## LÄMMITYSLAITTEEN MOOTTORIT

### ST0145

### T2321

### T6003

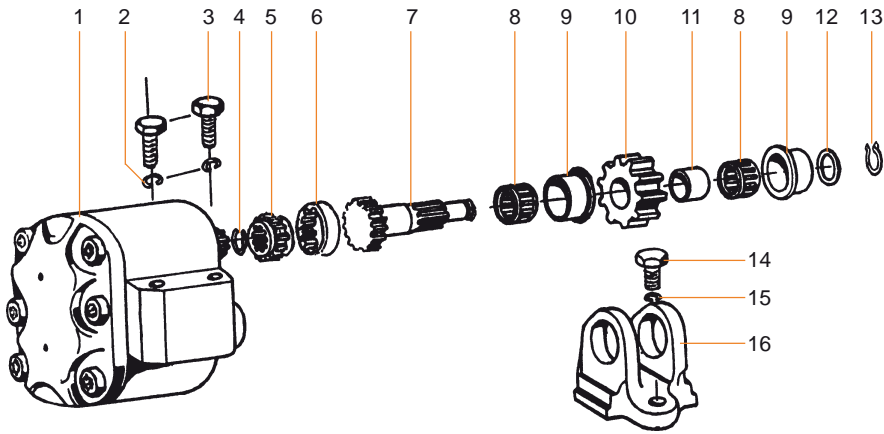

## KIINNITYSSARJA

### VPK5011

- kiinnityssarja tarvitaan vanhemmissa malleissa, joissa pumppu on koottu normaaleilla kuusio-kantaruuveilla
- sarja sisältää osat 4, 5, 6, 7, 12 ja 13

## HYDRAULIPUMPPU

### T6000A

- sopii suoraan CRYSTAL (UR2) sekä URSUS-traktoreihin vuosimallista 83 eteenpäin

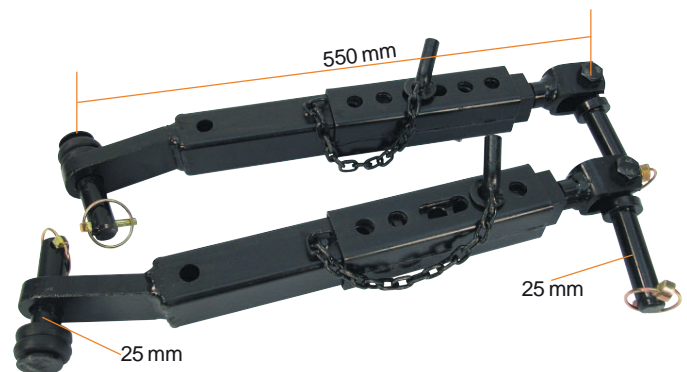
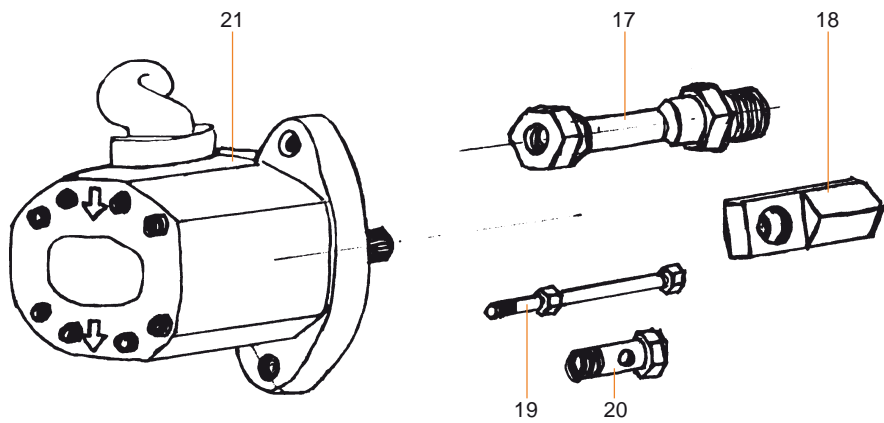

## SIVURAJOITINPARI

### T0411

- Ursus 4 ja 6-sylinteriset Zetor Crystal mallit
- sisäosa 40 x 40 mm
- sokkatappi 16 mm

01.12.2009



TF4503

TF7094

TF2593

TF2593-2

TF51058

TF51059

TF21204

TRAKTORI-MALLI	ÖLJYN-SUODATIN	POLTTO-AINE-SUODATIN	ILMANSUODATIN ULOMPI	ILMANSUODATIN SISEMPI	HYDRAULIIKKA-SUODATIN	OHJAUKSEN SUODATIN	OHJAAMON SUODATIN
25, 2011, 2511, 3011, 3045, 3511	TF5164 931107	TF8019 (a) 931207 TF7094 (b) 931209			TF51058 70114566		
3320, 3340 4320, 4340	TF4503 DFP550020 77010793	TF7204 931260	TF2593 71011292	TF2593-2	TF51058 70114566	TF51059 931140	TF21098 945900
3545, 4011, 4511, 5011, 5511, 5545	TF5164 931107	TF8019 (a) 931207 TF7094 (b) 931209				TF51058 70114566	
3321, 3341, 4321, 4341	TF4503 DFP550020 77010793	TF7233 931273	TF2526 79011284	TF2526-2 79011285	TF4342 53420903		
4712, 4911, 4945	TF5164 931107	TF8019 (a) 931207 TF7094 (b) 931209			TF51058 70114566		
5011, 5045, 6011, 6045		TF8019 (a) 931207 TF7094 (b) 931209			TF51058 70114566		TF21038 SY72163 TF21204 945901
5211, 5245	TF5164 931107	TF8019 (a) 931207 TF7094 (b) 931209			TF51058 70114566	TF51059 931140	TF21204 945901 TF21098 (c) 945900
5320, 5340 5340H	TF4503 DFP550020 77010793	TF7204 931260	TF2593 71011292	TF2593-2	TF51058 70114566	TF51059 931140	
5321, 5341	TF4503 DFP550020 77010793	TF7233 931273	TF2526 79011284	TF2526-2 79011285	TF4342 53420903		TF21180 (x2) 53371907
5711, 5745	TF5164 931107	TF8019 (a) 931207 TF7094 (b) 931209			TF51058 70114566		TF21038 SY72163
5911, 5945, 6911, 6945		TF8019 (a) 931207 TF7094 (b) 931209			TF51058 70114566		
6211		TF8019 (a) 931207 TF7094 (b) 931209			TF51058 70114566	TF51059 931140	TF21204 945901 TF21098 (c) 945900

a - karkea suodatin

b - hieno suodatin

c - vuodesta 1987 eteenpäin

01.12.2009



TRAKTORI-MALLI	ÖLJYN-SUODATIN	POLTTO-AINE-SUODATIN	ILMANSUODATIN ULOMPI	ILMANSUODATIN SISEMPI	HYDRAULIIKKA-SUODATIN	OHJAUKSEN SUODATIN	OHJAAMON SUODATIN
6320, 6340	<b>TF4503</b> <b>DFP550020</b> 77010793	<b>TF7204</b> 931260	<b>TF2593</b> 71011292	<b>TF2593-2</b>	<b>TF51058</b> 70114566	<b>TF51059</b> 931140	<b>TF21098</b> 945900
6321, 6341	<b>TF4503</b> <b>DFP550020</b> 77010793	<b>TF7233</b> 931273	<b>TF2526</b> 79011284	<b>TF2526-2</b> 79011285	<b>TF4342</b> 53420903		<b>TF21180</b> (x2) 53371907
6711, 6745		<b>TF8019</b> (a) 931207 <b>TF7094</b> (b) 931209			<b>TF51058</b> 70114566		<b>TF21038</b> SY72163
7011, 7045		<b>TF8019</b> (a) 931207 <b>TF7094</b> (b) 931209			<b>TF51058</b> 70114566		<b>TF21204</b> (x2) 945901
6245, 7211, 7245		<b>TF8019</b> (a) 931207 <b>TF7094</b> (b) 931209			<b>TF51058</b> 70114566	<b>TF51059</b> 931140	<b>TF21204</b> (x2) 945901 <b>TF21098</b> (c) 945900
7320, 7340	<b>TF4074</b> <b>DFP559418</b> 68016093	<b>TF7204</b> 931260	<b>TF2593</b> 71011292	<b>TF2593-2</b>			
7321, 7341	<b>TF4503</b> <b>DFP550020</b> 777010793	<b>TF7233</b> 931273	<b>TF2526</b> 79011284	<b>TF2526-2</b> 79011285	<b>TF4342</b> 53420903		<b>TF21180</b> (x2) 53371907
7520, 7540	<b>TF4074</b> <b>DFP559418</b> 68016093	<b>TF7204</b> 931260	<b>TF2197</b> <b>DFP771561</b> 10011906	<b>TF2197-2</b> 10011907	<b>TF51068</b> 78420908		<b>TF21137</b> 78371439
7711, 7745		<b>TF8019</b> (a) 931207 <b>TF7094</b> (b) 931209			<b>TF51058</b> 70114566	<b>TF51059</b> 931140	<b>TF21098</b> (c) 945900 <b>TF21204</b> (x2) 945901
7745 SPECIAL	<b>TF4085</b> <b>DFP554407</b> 923479	<b>TF7204</b> 931260					<b>TF21098</b> (c) 945900 <b>TF21204</b> (x2) 945901
8011, 8045		<b>TF8018</b> (a) 93009904 <b>TF7022</b> (b) 93009905	<b>TF2227</b> 93012504		<b>TF4111</b> 93407505	<b>TF4111</b> 93407505	
8145		<b>TF8018</b> (a) 93009904 <b>TF7022</b> 93009905	<b>TF2227</b> 93012504		<b>TF51053</b> 89407110	<b>TF4111</b> 93407505	<b>TF21204</b> (x2) 945901 <b>TF21098</b> (c) 945900
9145, 10145		<b>TF8018</b> (a) 93009904 <b>TF7022</b> (b) 93009905			<b>TF51053</b> 89407110	<b>TF4111</b> 93407505	<b>TF21204</b> (x2) 945901 <b>TF21098</b> (c) 945900

a - karkea suodatin

b - hieno suodatin

c - vuodesta 1987 eteenpäin malleihin, joissa vain yksi suodatin



01.12.2009



TF4074

TF7094

TF2197

TF2197-2

TF51068

TF51059

TF21204

TRAKTORI-MALLI	ÖLJYN-SUODATIN	POLTTO-AINE-SUODATIN	ILMANSUODATIN ULOMPI	ILMANSUODATIN SISEMPI	HYDRAULIIKKA-SUODATIN	OHJAUKSEN SUODATIN	OHJAAMON SUODATIN
8520, 8540, 9520, 9540	<b>TF4074</b> <b>DFP559418</b> 68016093	<b>TF7204</b> 931260	<b>TF2197</b> <b>DFP771561</b> 10011906	<b>TF2197-2</b> 10011907	<b>TF51068</b> 78420908		<b>TF21137</b> 78371439
10111		<b>TF8018</b> (a) 93009904 <b>TF7022</b> (b) 93009905			<b>TF51053</b> 89407110	<b>TF4111</b> 93407505	
8245, 9245, 10245		<b>TF8018</b> (a) 93009904 <b>TF7022</b> (b) 93009905	<b>TF21017</b> 83012915	<b>TF21017-2</b> 83012916	<b>TF51053</b> (x2) 89407110	<b>TF4111</b> 93407505	<b>TF21204</b> 945901 <b>TF21098</b> (c) 945900
10520, 10540	<b>TF4074</b> <b>DFP559418</b> 68016093	<b>TF7204</b> 931260	<b>TF2197</b> <b>DFP771561</b> 10011906	<b>TF2197-2</b> 10011907	<b>TF51068</b> 78420908	<b>TF51059</b> 931140	
10621, 11641	<b>TF4074</b> <b>DFP559418</b> 68016093	<b>TF7204</b> 931260	<b>TF2197</b> <b>DFP771561</b> 10011906	<b>TF2197-2</b> 10011907	<b>TF51068</b> 78420908		<b>TF21180</b> 53371907
12011, 12045		<b>TF8019</b> (a) 931207 <b>TF7094</b> (b) 931209			<b>TF4111</b> 93407505	<b>TF4111</b> 93407505	
12145 14145 16145		<b>TF8019</b> (a) 931207 <b>TF7094</b> (b) 931209			<b>TF51053</b> 89407110	<b>TF4111</b> 93407505	<b>TF21204</b> 945901 <b>TF21098</b> (c) 945900
12245, 14245 16245	<b>TF4114</b> 64001006	<b>TF8019</b> (a) 931207 <b>TF7094</b> (b) 931209	<b>TF21017</b> 83012915	<b>TF21017-2</b> 83012916	<b>TF51053</b> (x2) 89407110	<b>TF4111</b> 93407505	
3320, 3340, 4320, 4340, 5211, 5340, 5245, 5320 6211, 6245, 6320, 6340, 7320, 7340, 7520, 7540, 7711, 7745, 8520, 8540, 9520, 9540, 10520, 10540		<b>TF7204</b> (d) 931260					

a - karkea suodatin

b - hieno suodatin

c - vuodesta 1987 eteenpäin

d - malleihin, joissa vain yksi suodatin

22.10.2010



TF4501



TF7022



TF4111

TRAKTORI-MALLI	MOOTTORI-ÖLJYN-SUODATIN	POLTTO-AINE-SUODATIN	ILMAN-SUODATIN	HYDRAULIIKKA-SUODATIN	OHJAUS-TEHOSTIMEN SUODATIN
385, 385-4	TF4501 DFP552819	TF8018 (a) TF7022 (b)	TF2227	TF4111	TF4111
385, 385-4 Turbo	TF4501 DFP552819 TF4107 Turbonsuodatin	TF8018 (a) TF7022 (b)	TF2227	TF4111	TF4111
1201, 1204	TF4501 DFP552819	TF8019 (a) TF7094 (b)		TF4111	TF4111
1201, 1204 Turbo	TF4501 DFP552819 TF4107 Turbonsuodatin	TF8019 (a) TF7094 (b)		TF4111	TF4111
902, 904 912, 914	TF4501 DFP552819	TF8018 (a) TF7022 (b)	TF2227	TF4111	TF4111
902, 904 Turbo 912, 914 Turbo	TF4501 DFP552819 TF4107 Turbonsuodatin	TF8018 (a) TF7022 (b)	TF2227	TF4111	TF4111
1214, 1224	TF4501 DFP552819	TF8019 (a) TF7094 (b)		TF4111	TF4111
1214, 1224 Turbo	TF4501 DFP552819 TF4107 Turbonsuodatin	TF8019 (a) TF7094 (b)		TF4111	TF4111

a - karkea

b - hieno



## HYDRAULIIKKASUODATIN

### TF51053

89407110

- 87→

- pit. x lev. x reiät = 122 x 98 x 21/0

11.34