



## TRAKTORIMALLISTA MOOTTORITYYPIIN

TRAKTORI-MALLI	SYLINTERI-LUKU	SYLINTERI-HALKAISJA	MOOTTORI-TYYPPI
830	3	102	3164D
840	3	106,5	3179D
930	3	102	3164D
940	3	106,5	3179D
1020 (a)	3	98	3164D
1020 (b), 1030	3	102	3164D
1040	3	106,5	3179D
1120	3	98	3164D
1130	3	102	3164D
1140, 1350, 1550, 1630	3	106,5	3179D
1640	4	106,5	4239D
1750	3	106,5	3179D
1830	4	102	4219D
1840	4	106,5	4239D
1850, 1850N	3	106,5	3179D
1950, 1950N	3	106,5	3179T
2020	4	98	4202D
2030	4	102	4219D
2040, 2040S	4	106,5	4239D
2120	4	102	4219D
2130	4	106,5	4239D
2140	4	106,5	4239T
2250, 2450	4	106,5	4239D
2650, 2650N, 2850	4	106,5	4239T

TRAKTORI-MALLI	SYLINTERI-LUKU	SYLINTERI-HALKAISJA	MOOTTORI-TYYPPI
3020	4	102	4239D
3030	6	102	6329D
3040, 3050	6	106,5	6359D
3120	6	98	6303D
3130	6	102	6329D
3140, 3350, 3640	6	106,5	6359D
3650, 4040, 4040S, 4050	6	106,5	6359T
6100	4	106,5	4045D
6200, 6300	4	106,5	4039T
6400	4	106,5	4045T
6600	6	106,5	6059T
6800, 6900, 7400, 7600	6	106,5	6068T
7700, 7800	6	115,8	6076T
6010SE	4	106,5	4045D
6110SE, 6210SE, 6310SE, 6410SE	4	106,5	4045TL
6510	6	106,5	6068D
6610, 6810, 6910	6	106,5	6068TLA
7610	6	106,5	6068T
7710, 7810	6	115,9	6081T

a - →085099

b - 085100→

25.07.2008



TRAKTORI-MALLI	MOOTTORI-TYYPPI	SYLINTERI-PUTKI-SARJA (e, f)	SYLINTERI-PUTKI	SYLINTERI-PUTKEN TIIVISTE-SARJA	MÄNTÄ (a, e)	MÄNNÄN-RENGAS-SARJA	KIERTO-KANGEN PULTTI
3-sylinteriset 1020 (085100→199742)	3164D					VPB4911 AR55759	
1020 (c) (199743→)	3164D	VPB9653				VPB4911 AR55759	VPB6108 (g) R80033
1020 (d) (199743→)	3164D					VPB4911 AR55759	VPB6108 (g) R80033
1020 (→074999)	3164D					VPB4911 AR55759	
1020 (075000→199742)	3164D					VPB4911 AR55759	
1020 (c) (199743→)	3164D	VPB9653				VPB4911 AR55759	VPB6108 (g) R80033
1020 (d) (199743→)	3164D					VPB4911 AR55759	VPB6108 (g) R80033
830, 930 (c) 1030, 1130	3164D	VPB9653				VPB4911 AR55759	
830, 930 (d) 1030, 1130	3164D					VPB4911 AR55759	
1630	3179D	VPB9662 RE24458	VPB1029 R80724	VPB7210 AR65507	VPB2930 AR79868	VPB4912 RE15674	
840, 940 1040, 1140	3179D	VPB9662 RE24458	VPB1029 R80724	VPB7210 AR65507	VPB2930 AR79868	VPB4912 RE15674	VPB6108 (g) R80033
1350, 1550 1750, 1850 1850N	3179D	VPB9662 RE24458	VPB1029 R80724	VPB7210 AR65507	VPB2930 AR79868	VPB4912 RE15674	VPB6108 (g) R80033
1950, 1950N	3179D	VPB9663 RE22678	VPB1029 R80724	VPB7210 AR65507		VPB4912 RE15674	VPB6108 (g) R80033
4-sylinteriset							
2120 (→074999)	4219D					VPB4911 AR55759	
2120 (075000→199742)	4219D					VPB4911 AR55759	

Katso huomautukset seuraavalta sivulta

25.07.2008



TRAKTORI-MALLI	MOOTTORI-TYYPPI	SYLINTERI-PUTKI-SARJA (e, f)	SYLINTERI-PUTKI	SYLINTERI-PUTKEN TIIVISTE-SARJA	MÄNTÄ (a, e)	MÄNNÄN-RENGAS-SARJA	KIERTO-KANGEN PULTTI	KIERTO-KANGEN YLÄPÄÄN HELA
4-sylinteriset jatkuu								
2120 (c) (199743→)	4219D	VPB9653				VPB4911 AR55759	VPB6108 (g) R80033	
2120 (d) (199743→)	4219D					VPB4911 AR55759	VPB6108 (g) R80033	
1830, 2030 (c)	4219D	VPB9653				VPB4911 AR55759		
1830, 2030 (d)	4219D					VPB4911 AR55759		
2130	4239D	VPB9662 RE24458	VPB1029 R80724	VPB7210 AR65507	VPB2930 AR79868	VPB4912 RE15674		
1640, 1840 2040, 2040S	4239D	VPB9662 RE24458	VPB1029 R80724	VPB7210 AR65507	VPB2930 AR79868	VPB4912 RE15674	VPB6108 (g) R80033	
2140 (c)	4239T		VPB1029 R80724	VPB7210 AR65507		VPB4912 RE15674	VPB6108 (g) R80033	VPB7014 R57451
2140	4239T	VPB9663 RE15597	VPB1029 R80724	VPB7210 AR65507		VPB4912 RE15674	VPB6108 (g) R80033	VPB7014 R57451
2250, 2450	4239D	VPB9662 RE24458	VPB1029 R80724	VPB7210 AR65507	VPB2930 AR79868	VPB4912 RE15674	VPB6108 (g) R80033	
2650, 2650N 2850	4239T	VPB9663 RE22678	VPB1029 R80724	VPB7210 AR65507		VPB4912 RE15674	VPB6108 (g) R80033	VPB7014 R57451
6-sylinteriset								
3030, 3130 (c)	6329D	VPB9653				VPB4911 AR55759		
3030, 3130 (d)	6329D					VPB4911 AR55759		
3040, 3140 3640	6359D	VPB9662 RE24458	VPB1029 R80724	VPB7210 AR65507	VPB2930 AR79868	VPB4912 RE15674	VPB6108 (g) R80033	
4040, 4040S (c)	6359T		VPB1029 R80724	VPB7210 AR65507		VPB4912 RE15674	VPB6108 (g) R80033	VPB7014 R57451
4040, 4040S	6359T	VPB9663 RE15597	VPB1029 R80724	VPB7210 AR65507		VPB4912 RE15674	VPB6108 (g) R80033	VPB7014 R57451
3050, 3350	6359D	VPB9662 RE24458	VPB1029 R80724	VPB7210 AR65507	VPB2930 AR79868	VPB4912 RE15674	VPB6108 (g) R80033	
3650	6359T	VPB9663 RE22678	VPB1029 R80724	VPB7210 AR65507		VPB4912 RE15674	VPB6108 (g) R80033	VPB7014 R57451

a - ei sisällä renkaita  
b - tiivisteurilla  
c - männässä merkintä "B"  
d - männässä merkintä "H"

e - sisältää männäntapin + lukot  
f - sisältää putken, tiivisteet, männän ja rengassarjan  
g - pultin pituus 59 mm



TRAKTORI-MALLI	MOOTTORI-TYYPPI	SYLINTERI-PUTKI-SARJA	SYLINTERI-PUTKI	SYLINTERI-PUTKEN TIIVISTE-SARJA	MÄNTÄ	MÄNNÄN-RENGAS-SARJA	KIERTO-KANGEN PULTTI	KIERTO-KANGEN YLÄPÄÄN HELA
6010	4045D	<b>T6700</b> RE35966	<b>T6703</b> R116383	<b>VPB7210</b> AR65507	<b>T6698</b> RE59279	<b>T6702</b> RE66271	<b>T6728</b> R114083 A = 64 mm	<b>T6726</b> R123960
6110, 6205, 6210, 6310, 6410	4045T	<b>T6701</b> RE65969	<b>T6703</b> R116383	<b>VPB7210</b> AR65507	<b>T6699</b> RE55512	<b>T6707</b> RE66820	<b>T6728</b> R114083 A = 64 mm	<b>T6727</b> R114082
6505, 6510 26/3-82	6068D	<b>T6700</b> RE35966	<b>T6703</b> R116383	<b>VPB7210</b> AR65507	<b>T6698</b> RE59279	<b>T6702</b> RE66271	<b>T6728</b> R114083 A = 64 mm	<b>T6726</b> R123960
6610, 6810 6910 26/3-82	6068T	<b>T6701</b> RE65969	<b>T6703</b> R116383	<b>VPB7210</b> AR65507	<b>T6699</b> RE55512	<b>T6707</b> RE66820	<b>T6728</b> R114083 A = 64 mm	<b>T6727</b> R114082

02.03.2007

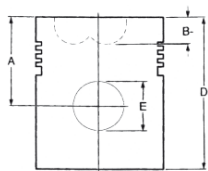
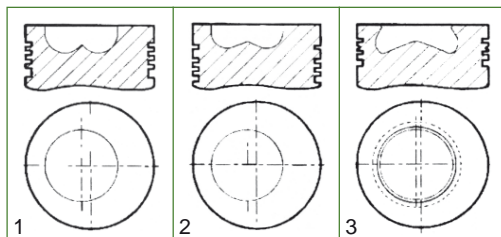

A - männän keskiökorkeus mm  
 B - palotilan syvyys mm  
 D - kokonaispituus mm  
 E - männäntapin halkaisija mm



TUOTE- NUMERO	∅ mm	MALLI	RENGAS- LUKU	TERÄS- VAHVIS- TEINEN	A mm	B mm	D mm	E mm
VPB3020	102	2	3	kyllä	66,42	21,50	112	34,92
VPB3000	106,50	2	3	kyllä	66,30	18,75	112	34,92
	106,50	2	3	kyllä	66,42	18,75	112	34,92
VPB3010	106,50	2	3	kyllä	66,30	19,65	112	41,27
	106,50	2	3	kyllä	66,42	19,65	112	41,27
T6698	106,50	2	3		72,50	24	110,50	35
T6699	106,50	2	3		71,60	25,10	114,50	41,20



TUOTE- NUMERO	MOOTTORI- TYYPPI	SYLINTERIN HALKAISIJA			
VPB4911	3164D, 4219D, 6329D	102,00 mm			
			3,00 mm	2,38 mm	5,00 mm
VPB4912	3179D, 4239D, 6359D, 3179T, 4239T, 6359T	106,50 mm			
			3,00 mm	2,38 mm	3,50 mm
T6702	Power Tech	116 mm			
			2,10 mm	2,10 mm	3,20 mm
T6707	Power Tech	116 mm			
			3,00 mm	2,10 mm	3,20 mm

02.03.2007

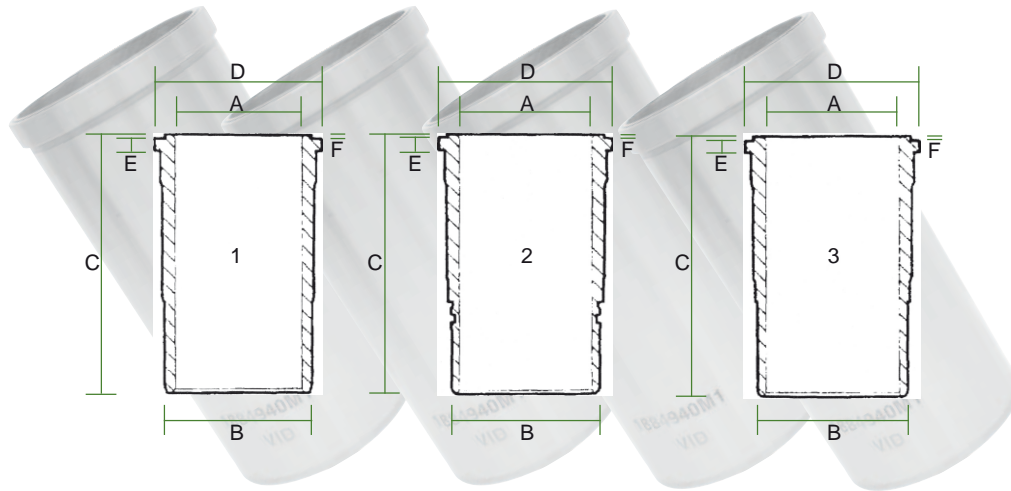

A - nimellinen halkaisija mm    C - kokonaispituus mm    E - laipan vahvuus mm  
 B - ulkohalkaisija mm    D - laipan halkaisija mm    F - laipan ylitys mm

TUOTENUMERO	MALLI	A	B	C	D	E	F
	3	102	111	197	125	6	0,75
<b>VPB1029</b>	1	106,50	115,70	196,50	126	6	0,75
<b>T6703</b>	3	106,50	116,20	219	126,50	6	1



25.07.2008



VPC2250

TRAKTORI-MALLI	MOOTTORI-TYYPPI	KIERTOKANGEN LAAKERISARJA			RUNKOLAAKERISARJA		
		STD	-0.010"	-0.020"	STD	-0.010"	-0.020"
3-sylinteriset 1020, 1120	3164D	VPC2250 3 x AT21138	VPC2251 3 x AT21124				VPC3282 4 x AT21112 1 x AT21134
830, 930 1030, 1130	3164D	VPC2250 3 x AT21138	VPC2251 3 x AT21124				VPC3282 4 x AT21112 1 x AT21134
1630	3179D	VPC2250 3 x AT21138	VPC2251 3 x AT21124				VPC3282 4 x AT21112 1 x AT21134
840, 940 1040, 1140	3179D	VPC2250 3 x AT21138	VPC2251 3 x AT21124				
4-sylinteriset 2020	4202D	VPC2260 4 x AT21138	VPC2261 4 x AT21124	VPC2262 4 x AT21126	VPC3280 4 x AT21140 1 x AT21139	VPC3281 4 x AT21110 1 x AT21132	VPC3282 4 x AT21112 1 x AT21134
2120, 1830 2030	4219D	VPC2260 4 x AT21138	VPC2261 4 x AT21124	VPC2262 4 x AT21126	VPC3280 4 x AT21140 1 x AT21139	VPC3281 4 x AT21110 1 x AT21132	VPC3282 4 x AT21112 1 x AT21134
2130	4239D	VPC2260 4 x AT21138	VPC2261 4 x AT21124	VPC2262 4 x AT21126	VPC3280 4 x AT21140 1 x AT21139	VPC3281 4 x AT21110 1 x AT21132	VPC3282 4 x AT21112 1 x AT21134
1640, 1840 2040, 2040S	4239D	VPC2260 4 x AT21138	VPC2261 4 x AT21124	VPC2262 4 x AT21126	VPC3280 (c) 4 x AT21140 1 x AT21139	VPC3281 (c) 4 x AT21110 1 x AT21132	VPC3282 (c) 4 x AT21112 1 x AT21134
2140	4239T	VPC2310 4 x RE27348			VPC3280 (a) 4 x AT21140 1 x AT21139 VPC3300 (b) 4 x AT21140 1 x RE27350	VPC3281 (a) 4 x AT21110 1 x AT21132	VPC3282 (a) 4 x AT21112 1 x AT21134
2250 2450	4239D	VPC2310 4 x RE27348					

Katso huomautukset seuraavalta sivulta

25.07.2008



VPC2250

T6724

T6722

TRAKTORI-MALLI	MOOTTORI-TYYPPI	KIERTOKANGEN LAAKERISARJA STD	-0.010"	RUNKOLAAKERI-SARJA STD
4-sylinteriset jatkuu 2650 2650N 2850	4239T	2 x VPC2250 4 x RE27348	2 x VPC2251 4 x RE27349	
6-sylinteriset 3120	6303D	2 x VPC2250 6 x AT21138 2 x VPC2250	2 x VPC2251 6 x AT21124 2 x VPC2251	VPC3290 6 x AT21140 1 x AT21139
3030 3130	6329D	2 x VPC2250 6 x AT21138 2 x VPC2250	2 x VPC2251 6 x AT21124 2 x VPC2251	VPC3290 6 x AT21140 1 x AT21139
3040 3140	6359D	2 x VPC2250 6 x AT21138 2 x VPC2250	2 x VPC2251 6 x AT21124 2 x VPC2251	VPC3290 (a) 6 x AT21140 1 x AT21139
3640	6359D	2 x VPC2250 6 x AT21138 2 x VPC2250	2 x VPC2251 6 x AT21124 2 x VPC2250	
6010	4045D	T6724 4 x RE65908		T6722 4 x RE65165 1 x RE65168
6110, 6205, 6210, 6310, 6410	4045T	T6724 4 x RE65908		T6722 4 x RE65165 1 x RE65168
6505, 6510 26/3-82	6068D	T6725 6 x RE65908		T6723 6 x RE65165 1 x RE65168
6610, 6810, 6910 26/3-82	6068T	T6725 6 x RE65908		T6723 6 x RE65165 1 x RE65168

- a - →484963
- b - 484964→
- c - →429999
- d - 430000→





VPC4714



VPC5117

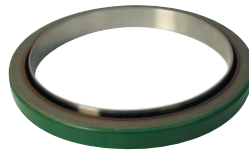

VPC5014

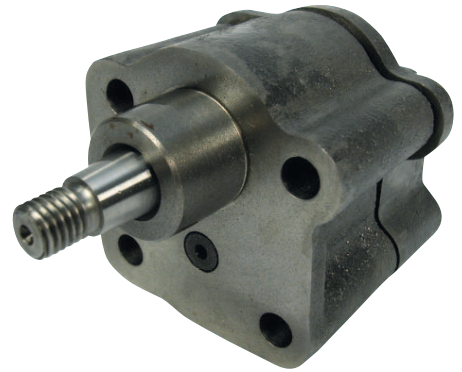

VPD1032

TRAKTORI-MALLI	MOOTTORI-TYYPPI	PÄITTÄIS-LAAKERI-SARJA STD	JAKOPÄÄN HUULI-TIIVISTE	TAKAPÄÄN HUULI-TIIVISTE	ÖLJY-PUMPPU
3-sylinteriset 1020, 1120	3164D		VPC5117 AR67942	VPC5014 (a) RE24959	
830, 930 1030, 1130	3164D		VPC5117 AR67942	VPC5014 RE24959	VPD1032
1630	3179D		VPC5117 AR67942	VPC5014 RE24959	VPD1032
840, 940, 1040, 1140, 1350, 1550, 1750, 1850, 1850N	3179D	VPC4714 RE13571	VPC5117 AR67942	VPC5014 RE24959	VPD1032
1950, 1950N	3179T	VPC4714 RE13571	VPC5117 AR67942	VPC5014 RE24959	VPD1032
4-sylinteriset 2020 2120	4202D		VPC5117 AR67942	VPC5014 (a) RE24959	
1830 2030	4219D		VPC5117 AR67942	VPC5014 RE24959	VPD1032
2130	4239D		VPC5117 AR67942	VPC5014 RE24959	VPD1032
1640, 1840 2040, 2040S	4239D	VPC4714 RE13571	VPC5117 AR67942	VPC5014 RE24959	VPD1032
2140	4239T	VPC4714 (b) RE13571	VPC5117 AR67942	VPC5014 RE24959	VPD1032
2250, 2450	4239D	VPC4714 RE13571	VPC5117 AR67942	VPC5014 RE24959	VPD1032
2650, 2650N 2850	4239T	VPC4714 RE13571	VPC5117 AR67942	VPC5014 RE24959	VPD1032
6-sylinteriset 3120	6303D		VPC5117 AR67942	VPC5014 (a) RE24959	
3030, 3130	6329D		VPC5117 AR67942	VPC5014 RE24959	VPD1032
3040, 3140	6359D	VPC4714 (b) RE13571	VPC5117 AR67942	VPC5014 RE24959	VPD1032
3640	6359D	VPC4714 (b) RE13571	VPC5117 AR67942	VPC5014 RE24959	VPD1032
4040	6359T	VPC4714 RE13571	VPC5117 AR67942	VPC5014 RE24959	
4040S	6359T	VPC4714 RE13571	VPC5117 AR67942	VPC5014 RE24959	
3050, 3350	6359D	VPC4714 RE13571	VPC5117 AR67942	VPC5014 RE24959	VPD1032
3650	6359T	VPC4714 RE13571	VPC5117 AR67942	VPC5014 RE24959	VPD1032
6010	4045D		T6721 RE59810	VPC5014 RE24959	
6110, 6205, 6210, 6310, 6410	4045T		T6721 RE59810	VPC5014 RE24959	
6505, 6510	6068D		T6721 RE59810	VPC5014 RE24959	
6610, 6810, 6910	6068t		T6721 RE59810	VPC5014 RE24959	

a - 046068→

b - 484964→

**J1.09**

Alkuperäisnumerot ovat ainoastaan vertailua varten, eivätkä tarkoita, että tuotteet ovat alkuperäisiä.  
Taulukoissa esiintyvät kuvat ovat viitteellisiä.

02.03.2007



TRAKTORI-MALLI	MOOTTORI-TYYPPI	VENTTIILIN KORJAUS-SARJA	IMUVENTTIILI		PAKOVENTTIILI		VENTTIILIN LUKKO (pari)
			STD	STD	STD	+0.015"	
3-sylinteriset 1020, 1120 830, 930 1030, 1130	3164D	VPA6050	VPA1350 R52251 R79623	VPA1360 R52252 R79624	VPA1362 R57335 R79626	VPA2302 T20077	
1630, 840, 940, 1040, 1140, 1350, 1550, 1750	3179D	VPA6050	VPA1350 R79623	VPA1360 R79624	VPA1362 R79626	VPA2302 T20077	
1850, 1850N	3179D	VPA6050	VPA1350 R79623	VPA1360 R79624	VPA1362 R79626	VPA2302 T20077	
1950, 1950N	3179T	VPA6051		VPA1360 R79624	VPA1362 R79626	VPA2302 T20077	
4-sylinteriset 2020	4202D		VPA1350 R52251 R79623	VPA1360 R52252 R79624	VPA1362 R57335 R79626	VPA2302 T20077	
2120, 1830 2030	4219D		VPA1350 R52251 R79623	VPA1360 R52252 R79624	VPA1362 R57335 R79626	VPA2302 T20077	
2130, 1640 1840, 2040 2040S	4239D		VPA1350 R52251 R79623	VPA1360 R52252 R79624	VPA1362 R57335 R79626	VPA2302 T20077	
2140	4239T	VPA6053	VPA1370 R51735	VPA1360 R52252 R79624	VPA1362 R57335 R79626	VPA2302 T20077	
2250, 2450	4239D		VPA1350 R52251 R79623	VPA1360 R52252 R79624	VPA1362 R57335 R79626	VPA2302 T20077	
2650, 2650N 2850	4239T	VPA6054		VPA1360 R79624	VPA1362 R79626	VPA2302 T20077	
6-sylinteriset 3120	6303D		VPA1350 R52251 R79623	VPA1360 R52252 R79624	VPA1362 R57335 R79626	VPA2302 T20077	
3030, 3130	6329D		VPA1350 R52251 R79623	VPA1360 R52252 R79624	VPA1362 R57335 R79626	VPA2302 T20077	
3040, 3140 3640	6359D		VPA1350 R79623	VPA1360 R79624	VPA1362 R79626	VPA2302 T20077	
4040, 4040S	6359T	VPA6056	VPA1370 R51735	VPA1360 R52252 R79624	VPA1362 R57335 R79626	VPA2302 T20077	
3050, 3350	6359D		VPA1350 R52251 R79623	VPA1360 R52252 R79624	VPA1362 R57335 R79626	VPA2302 T20077	
3650	6359T	VPA6056	VPA1370 R51735	VPA1360 R52252 R79624	VPA1362 R57335 R79626	VPA2302 T20077	
6010	4045D		T6705 R98062	T6706 R90692		T6769 R91889	
6110, 6205, 6210, 6310, 6410	4045T		T6705 R98062	T6706 R90692		T6769 R91889	
6505, 6510	6068D		T6705 R98062	T6706 R90692		T6769 R91889	
6610, 6810, 6910	6068T		T6705 R98062	T6706 R90692		T6769 R91889	

**J1.10**

Alkuperäisnumerot ovat ainoastaan vertailua varten, eivätkä tarkoita, että tuotteet ovat alkuperäisiä.  
Taulukoissa esiintyvät kuvat ovat viitteellisiä.

25.07.2008

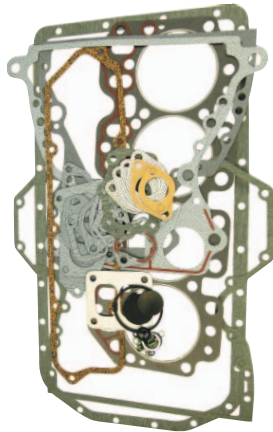

VPA4406

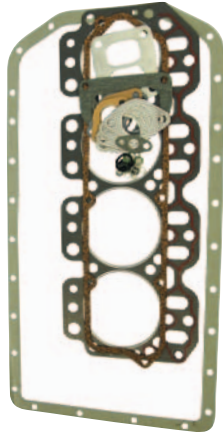

VPA4036

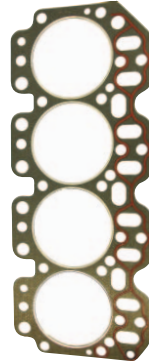

VPA4333



VPA4525



VPC6039

TRAKTORI-MALLI	MOOTTORI-TYYPPI	TÄYD. TIIVISTE-SARJA	YLÄ-TIIVISTE-SARJA	KANNEN-TIIVISTE	VENTTIILI-KANNEN TIIVISTE	ALA-TIIVISTE-SARJA
4-sylinteriset 2020	4202D			VPA4333 R92425	VPA4525 R73521	
2120	4219D			VPA4333 R92425	VPA4525 R73521	
1830 2030	4219D	VPA4406 RE38857	VPA4036 RE38851	VPA4333 R92425	VPA4525 R73521	
2130, 1640 1840, 2040, 2040S	4239D	VPA4406 RE38857	VPA4036 RE38851	VPA4333 R92425	VPA4525 R73521	
2140	4239T	VPA4406 RE38857	VPA4036 RE38851	VPA4333 R92425	VPA4525 R73521	
2250 2450	4239D	VPA4410 RE16922	VPA4036 RE38851	VPA4333 R92425	VPA4525 R73521	VPC6039 (d, e)
2650, 2650N 2850	4239T	VPA4410 RE16922	VPA4036 RE38851	VPA4333 R92425	VPA4525 R73521	VPC6039 (d, e)
6-sylinteriset 3120	6303D			VPA4334 R92426	VPA4526 R75728	
3030 3130	6329D	VPA4408 RE16925	VPA4038 RE38852	VPA4334 R92426	VPA4526 R75728	VPC6037 (d, e)
3040 3140 3640	6359D	VPA4408 RE16925	VPA4038 RE38852	VPA4334 R92426	VPA4526 R75728	VPC6037
4040 4040S	6359T	VPA4408 RE16925	VPA4038 RE38852	VPA4334 R92426	VPA4526 R75728	VPC6037
3050 3350	6359D		VPA4038 RE38852	VPA4334 R92426	VPA4526 R75728	
3650	6359T		VPA4038 RE38852	VPA4334 R92426	VPA4526 R75728	

a - →085099

b - 085100→

d - sarja ei sisällä kampiakselin etupään stefaa

e - sarja ei sisällä kampiakselin takapään stefaa



T6711

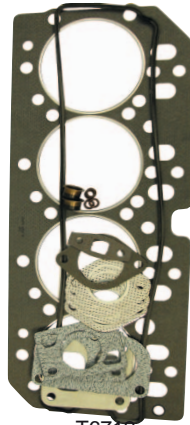

T6712

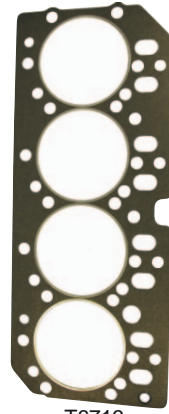

T6713



T6714

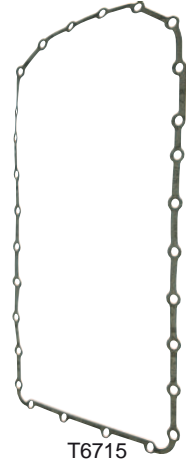

T6715

TRAKTORI-MALLI	MOOTTORI-TYYPPI	TÄYDELLINEN TIIVISTE-SARJA	YLÄ-TIIVISTE-SARJA	KANNEN-TIIVISTE	VENTTIILI-KANNEN-TIIVISTE	ÖLJY-POHJAN TIIVISTE
6010	4045D	<b>T6711</b> RE501455	<b>T6712</b> RE66082	<b>T6713</b> R116515	<b>T6714</b> R123542	<b>T6715</b> R123552
6110, 6205, 6210, 6310, 6410	4045T	<b>T6711</b> RE501455	<b>T6712</b> RE66082	<b>T6713</b> R116515	<b>T6714</b> R123542	<b>T6715</b> R123552
6505, 6510	6068D	<b>T6716</b> RE501456	<b>T6717</b> RE66085	<b>T6718</b> R116516	<b>T6719</b> R123543	<b>T6720</b> R123554
6610, 6810, 6910	6068T	<b>T6716</b> RE501456	<b>T6717</b> RE66085	<b>T6718</b> R116516	<b>T6719</b> R123543	<b>T6720</b> R123554



V153

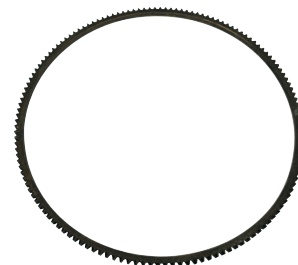

VPC4211

TRAKTORI-MALLI	MOOTTORI-TYYPPI	LOHKON HANA	STARTTI-KEHÄ
<b>3-sylinteriset</b>			
1020, 1120, 830, 930, 1030, 1130	3164D	V153 AT13740	VPC4211 T20088
1630, 840, 940, 1040, 1140, 1350, 1550, 1750, 1850, 1850N	3179D	V153 AT13740	VPC4211 T20088
1950, 1950N	3179T	V153 AT13740	VPC4211 T20088
<b>4-sylinteriset</b>			
2020	4202D	V153 AT13740	VPC4211 T20088
2120	4219D	V153 AT13740	VPC4211 T20088
1830, 2030	4219D	V153 AT13740	VPC4211 T20088
2130, 1640, 1840, 2040, 2040S	4239D	V153 AT13749	VPC4211 T20088
2140	4239T	V153 AT13740	VPC4211 T20088
2250 2450	4239D	V153 AT13740	VPC4211 T20088
2650, 2650N 2850	4239T	V153 AT13740	VPC4211 T20088
<b>6-sylinteriset</b>			
3120	6303D	V153 AT13740	VPC4211 T20088
3030 3130	6329D	V153 AT13740	VPC4211 T20088
3040, 3140, 3640	6359D	V153 AT13740	VPC4211 T20088
4040 4040S	6359T	V153 AT13740	VPC4211 T20088
3050 3350	6359D	V153 AT13740	VPC4211 T20088
3650	6359T	V153 AT13740	VPC4211 T20088
6010	4045D		VPC4211 T20088
6110, 6205, 6210, 6310, 6410	4045T		VPC4211 T20088
6505, 6510	6068D		T6710 R28811
6610, 6810, 6910	6068T		T6710 R28811



25.07.2008



TRAKTORI-MALLI	MOOTTORI-TYYPPI	VESIPUMPUN KORJAUS-SARJA	TUULETTAJAN-HIHNA	TERMOSTAATTI	TERMOSTAATIN TIIVISTE
3 sylinteriset 1020 1120	3164D	VPE2021 RE11345	VPE6025 (c) T23505	T2041 (a) AT22961 VPE3414 (b) AT22963	VPE3911 T20215
830 930 1630	3164D	VPE2021 RE11345		T2041 (a) AT22961 VPE3414 (b) AT22963	VPE3911 T20215
840, 940 1040, 1140	3179D	VPE2023 RE11347	VPE6027 R73784	VPE3405 AR61538	VPE3911 T20215
1350 1550 1750 1850, 1850N	3179D	VPE2021 RE11345	VPE6027 R73784	VPE3405 (e) AR61538 T2041 (f) AT22961	VPE3911 T20215
1950 1950N	3179T	VPE2021 RE11345	VPE6027 R73784	T2041 AT22961	VPE3911 T20215
4 sylinteriset 2020	4202D	VPE2021 RE11345	VPE6025 T23505	T2041 (a) AT22961 VPE3414 (b) AT22963	VPE3911 T20215
2120	4219D	VPE2021 RE11345	VPE6025 T23505	T2041 (a) AT22961 VPE3414 (b) AT22963	VPE3911 T20215
1830 2030	4219D	VPE2021 RE11345		T2041 (a) AT22961 VPE3414 (b) AT22963	VPE3911 T20215
2130	4239D	VPE2021 RE11345		VPE3405 AR61538	VPE3911 T20215
1640, 1840 2040, 2040S	4239D	VPE2023 (i) RE11347	VPE6027 R73784	VPE3405 AR61538	VPE3911 T20215
2140	4239T	VPE2023 (i) RE11347	VPE6027 R73784	VPE3405 AR61538	VPE3911 T20215
2250 2450	4239D	VPE2023 (i) RE11347	VPE6056 R87154	VPE3405 AR61538	VPE3911 T20215
2650 2650N, 2850	4239T	VPE2023 (i) RE11347	VPE6056 R87154	VPE3405 AR61538	VPE3911 T20215
6010	4045D			VPE3406 (a) AR48675	
6110, 6205, 6210, 6310, 6410	4045T			VPE3406 (a) AR48675	
6505, 6510	6068D			VPE3406 (a) AR48675	
6610, 6810 6910	6068T			VPE3406 (a) AR48675	
2255, 2355, 2555, 2755, 2855N				VPE3405 AR61538	

a - 82°C  
b - 89°C

c - →075344  
d - 075345→

e - vanhemmat mallit  
f - uudemmat mallit

i - →829916, noin 1989 asti

**J1.14**

Alkuperäisnumerot ovat ainoastaan vertailua varten, eivätkä tarkoita, että tuotteet ovat alkuperäisiä. Taulukoissa esiintyvät kuvat ovat viitteellisiä.



04.03.2011

## Huom.

Katso vesipumput sivulta J1.17

Katso tuulettimen hihnojen vertailutaulukko Tarvikeluettelon sivulta T6.16c.

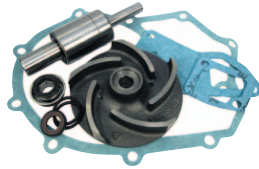

VPE2024



T6686



VPE6056



VPE3406

TRAKTORI-MALLI	MOOTTORI-TYYPPI	VESIPUMPUN KORJAUS-SARJA	TUULETTAJAN-HIHNA	TERMOSTAATTI
6-sylinteriset 3120	6303D	VPE2022 RE11346	VPE6027 R73784	
3030	6329D	VPE2022 RE11346	VPE6028 N150864	VPE3406 AR48675
3130	6329D	VPE2022 RE11346	VPE6028 N150864	VPE3406 (h) AR48675
3040 3140	6359D	VPE2024 RE11348	VPE6029 R73785	VPE3406 AR48675
3640	6359D	VPE2024 RE11348		VPE3406 AR48675
4040	6359T	VPE2024 RE11348	AVX13-1500 R46113	VPE3406 AR48675
4040S	6359T	VPE2024 RE11348		VPE3406 AR48675
3050 3350	6359D	VPE2024 RE11348		VPE3406 AR48675
3650	6359T	VPE2024 RE11348		VPE3406 AR48675
6010, 6110, 6205, 6210, 6310, 6410			T6686 L114489	
6100, 6200, 6300, 6400			T6692 (a) L111148, L79342 T6687 (c) L111169	
6506, 6600			T6687 L111169	
6200, 6400, 6506, 6600			T6688 L110605	
6310, 6410, 6510, 6610			T6689 L111600	
6505, 6510, 6610			T6691 L114488	
6800, 6900			T6694 L111804 T6695 L110599	
6810, 6910			T6696 (d) L114286, L114487	
6810, 6910			T6697 (e) L114292, L11599	

a - leveys 22 mm, pituus 1740 mm  
b - leveys 28 mm, pituus 1740 mm  
c - leveys 22 mm, pituus 1720 mm

d - leveys 28 mm, pituus 1900 mm  
e - leveys 28 mm, pituus 2500 mm  
h - 255170→

25.07.2008



F0256



V153



T4513



VPE4105

TRAKTORI-MALLI	MOOTTORI-TYYPPI	JÄÄHDYTTÄJÄN KORKKI	JÄÄHDYTTIMEN HANA	VÄLI-LETKU	YLÄ-VESILETKU	ALA-VESILETKU
<b>3-sylinteriset</b>						
1020 1120	3164D		<b>V153</b> AT13740			<b>VPE4104</b> T22500
830 930	3164D		<b>V153</b> AT13740			<b>VPE4104</b> T22500
1030 1130	3164D		<b>V153</b> AT13740			<b>VPE4104</b> T22500
1630	3179D		<b>V153</b> AT13740			<b>VPE4104</b> T22500
840 940	3179D		<b>V153</b> AT13740	<b>VPE4096</b> R70737	<b>T4513</b> L34920	<b>VPE4104</b> T22500
1040 1140	3179D		<b>V153</b> AT13740	<b>VPE4096 (c)</b> R70737	<b>T4513</b> L34920	<b>VPE4104</b> T22500
1350 1550	3179D		<b>V153 (c)</b> AT13740	<b>VPE4096 (c)</b> R70737	<b>T4513 (c)</b> L34920	<b>VPE4104 (c)</b> T22500
1750 1850, 1850N	3179D		<b>V153 (c)</b> AT13740	<b>VPE4096 (c)</b> R70737	<b>T4513 (c)</b> L34920	<b>VPE4104 (c)</b> T22500
<b>4-sylinteriset</b>						
2020	4202D		<b>V153</b> AT13740		<b>T2056</b> L29263	<b>VPE4104</b> T22500
2120	4219D		<b>V153</b> AT13740		<b>T2056</b> L29263	<b>VPE4104</b> T22500
1830 2030	4219D		<b>V153</b> AT13740		<b>T2056</b> L29263	<b>VPE4104</b> T22500
2130	4239D		<b>V153</b> AT13740		<b>T2056</b> L29263	<b>VPE4104</b> T22500
1640 1840	4239D		<b>V153</b> AT13740	<b>VPE4096</b> R70737	<b>VPE4100</b> L34898	<b>VPE4105</b> L34921
2040 2040S	4239D		<b>V153</b> AT13740	<b>VPE4096</b> R70737	<b>VPE4100</b> L34898	<b>VPE4105</b> L34921
2140 2040S	4239T		<b>V153</b> AT13740	<b>VPE4096</b> R70737	<b>VPE4100</b> L34898	<b>VPE4105</b> L34921
2250 2450	4239D	<b>F0256</b> AL56759	<b>V153</b> AT13740	<b>VPE4096</b> R70737	<b>VPE4170</b> L56296	<b>VPE4168</b> L56295
2650 2650N	4239T	<b>F0256</b> AL56759	<b>V153</b> AT13740	<b>VPE4096</b> R70737	<b>VPE4170</b> L56296	<b>VPE4168</b> L56295

c - →621999

25.07.2008



F0256



V153



VPE4103



VPE4107

TRAKTORI-MALLI	MOOTTORI-TYYPPI	JÄÄHDYTTÄJÄN KORKKI	JÄÄHDYTTIMEN HANA	YLÄ-VESILETKU	ALA-VESILETKU
<b>6-sylinteriset</b>					
3120	6303D		V153 AT13740		VPE4106 T28426
3030 3130	6329D		V153 AT13740		VPE4106 T28426
3040 3140 3640	6359D		V153 AT13740	VPE4103 L32456	VPE4107 L34922
4040 4040S	6359T		V153 AT13740	VPE4103 L32456	
3050 3350 3650	6359D	F0256 AL56759	V153 AT13740		



## VESIPUMPPU

### T6704

RE500734, RE500737, RE70683, RE70985  
- sopivuus: Power Tech -moottorit

## VESIPUMPPU

### T6660

RE25338, RE26955, RE46238, RE60489, RE92417, RE92418  
- 3 ja 4 sylinterisiin, 40- ja 50-sarjat  
- sisältää asennussarjan

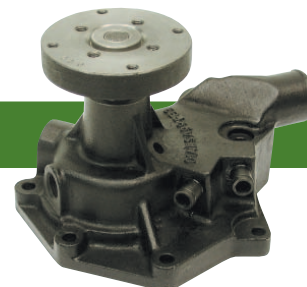

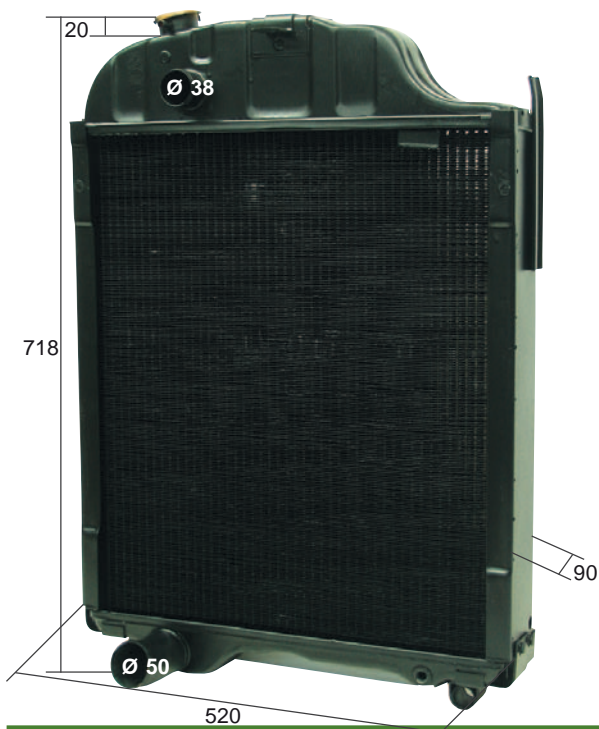

### T6675

AL56372

- sopii: 2250, 2450, 2650, 2650N, 2850 (→669788),  
2450, 2650, 2850, 2450F, 2650F (→165978)

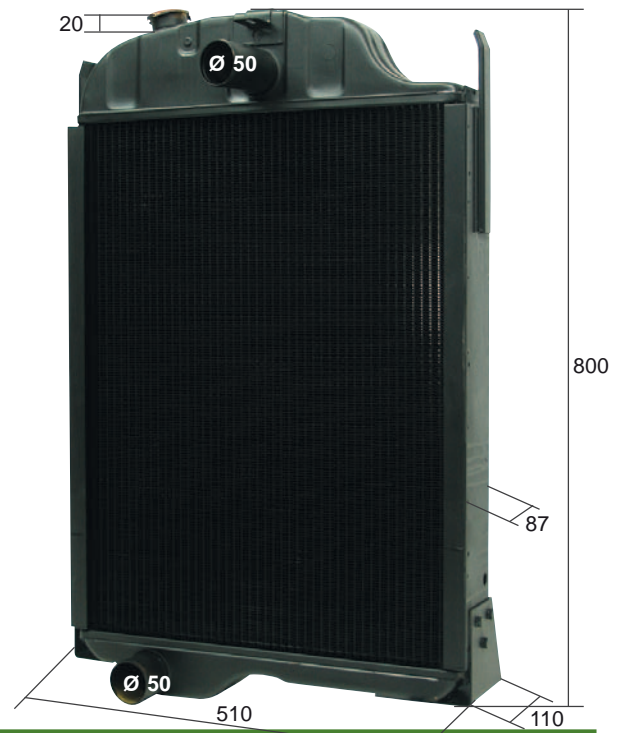

### T6676

AL56375

- sopii: 3050, 3150, 3350

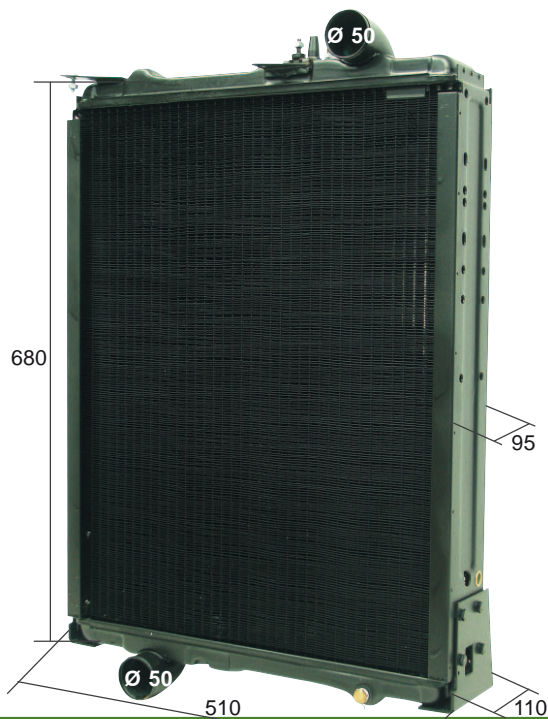

### T6677

AL66766

- sopii: W/ Cab, 2955, 3050, 3350, 3650 (664560→),  
3150, 3350

25.07.2008

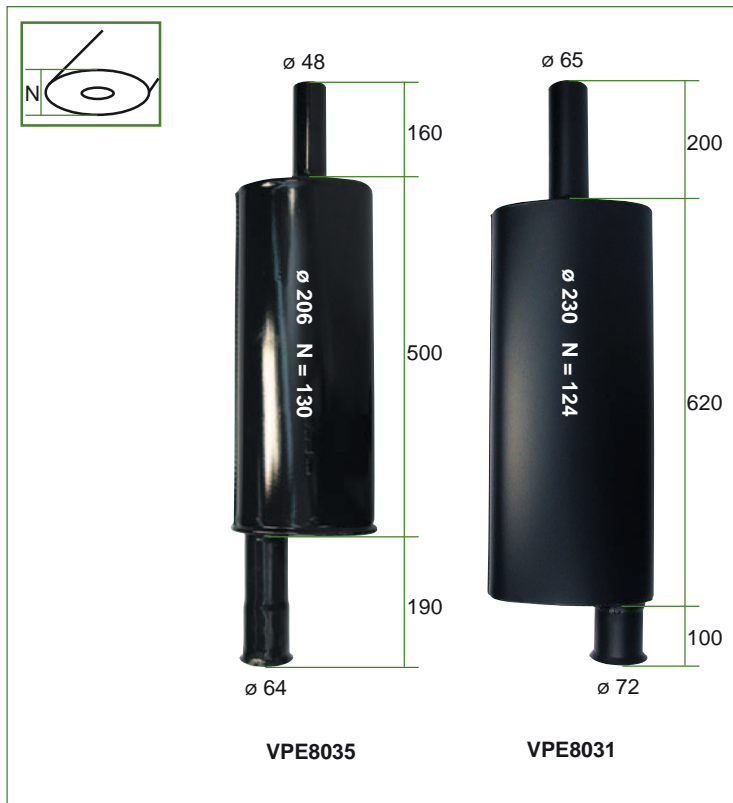

TRAKTORI-MALLI	MOOTTORI-TYYPPI	PAKOPUTKIPELLIN ALLE	PAKOPUTKEN HATTU	PAKO-SARJAN TIIVISTE	HEHKUTULPPA
3-sylinteriset 1020, 1120 830, 930 1030, 1130 1630	3164D 3179D			VPE3910 T20006 VPE3910 T20006	MF0441 AR63103 MF0441 AR63103
840, 940 1040, 1140	3179D	VPE8029 AL31552	VLD2060 (b) AL28307	VPE3910 T20006	MF0441 AR63103
1350	3179D	VPE8029 (c) AL31552	VLD2060 (b, d) AL28307	VPE3910 T20006	
1550, 1750 1850, 1850N	3179D	VPE8029 AL31552	VLD2060 (b) AL28307	VPE3910 T20006	
1950 1950N	3179T		VLD2060 AT28307	VPE3910 T20006	

Katso huomautukset seuraavalta sivulta



25.07.2008



T6665

T6664

VLD2058

VPE3910

MF0441

TRAKTORI-MALLI	MOOTTORI-TYYPPI	PYSTY-PAKOPUTKI	PAKOPUTKIPELLIN ALLE	PAKOPUTKEN HATTU	PAKOSARJAN TIIVISTE	HEHKUTULPPA
4-sylinteriset 2020	4202D	VPE8035 (a) AL27389			VPE3910 T20006	MF0441 AR63103
3020	4219D			VLD2055 AR86596		
2120 1830, 2030	4219D	VPE8035 (a) AL27389			VPE3910 T20006	MF0441 AR63103
2130	4239D	VPE8035 AL27389			VPE3910 T20006	MF0441 AR63103
1640 1840	4239D		VPE8030 AL31492	VLD2060 AL28307	VPE3910 T20006	MF0441 AR63103
2040 2040S	4239D		VPE8030 AL31492	VLD2060 AL28307	VPE3910 T20006	MF0441 AR63103
2140	4239T		VPE8056 AL35753	VLD2060 AL28307	VPE3910 T20006	MF0441 AR63103
2250 2450	4239D		VPE8030 AL31492	VLD2060 AL28307	VPE3910 T20006	
2650 2650N	4239T		VPE8056 AL35753	VLD2060 AL28307	VPE3910 T20006	
2850	4239T		VPE8056 AL35753	VLD2060 AL28307	VPE3910 T20006	
6-sylinteriset 3120	6303D	VPE8031 (a) AL24553		VLD2058 AT32240	VPE3910 T20006	
3030 3130	6329D	VPE8031 AL24553		VLD2058 AT32240 VLD2060 (b) AL28307	VPE3910 T20006	
3040 3140	6359D		VPE8032 (f) AL30338 VPE8033 (g) AL37167	VLD2060 AL28307	VPE3910 T20006	
3640	6359D		VPE8033 AL37167	VLD2060 AL28307	VPE3910 T20006	
4040 4040S	6359T			VLD2064 AR86600	VPE3910 T20006	
3050 3350	6359D			VLD2060 AL28307	VPE3910 T20006	
3650	6359T			VLD2060 AL28307	VPE3910 T20006	
6100, 6010			T6664 AL78007			
6110, 6200, 6205, 6210, 6300, 6310, 6400, 6410			T6665 AL113991 AL78267			

a - ei Ruotsissa

b - konepeiton alle tulevalla vaimentajalla

c - →621999

d - 622000→

e - 1330 mm

f - →252123

g - 252124→

J1.20



02.03.2007

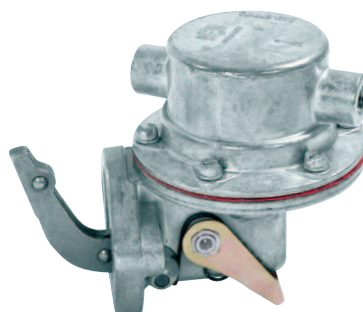

VPD3019



T6631

TRAKTORI-MALLI	MOOTTORI-TYYPPI	SIIRTOPUMPPU
3-sylinteriset 1020, 1120 830, 930, 1030 1130	3164D	VPD3019 (a) DD14292
1630	3179D	VPD3019 (a) DD14292
840 940	3179D	VPD3019 (a) DD14292
1040 1140	3179D	VPD3019 (a) DD14292
1350, 1550 1750, 1850 1850N	3179D	VPD3019 (a) tai T6631 DD14292
1950 1950N	3179T	VPD3019 (a) tai T6631 DD14292
4-sylinteriset 2020	4202D	VPD3019 (a) DD14292
2120, 1830 2030	4219D	VPD3019 (a) DD14292
2130, 1640 1840, 2040 2040S	4239D	VPD3019 (a) DD14292
2140	4239T	VPD3019 (a) DD14292
2250 2450	4239D	VPD3019 (a) tai T6631 DD14292
2650, 2650N 2850	4239T	VPD3019 (a) tai T6631 DD14292
6-sylinteriset 3120	6303D	VPD3019 (a) DD14292
3030 3130	6329D	VPD3019 (a) DD14292
3040 3140	6359D	VPD3019 (a) DD14292
3640	6359D	VPD3019 (a) DD14292
4040 4040S	6359T	VPD3019 (a) DD14292
3050 3350	6359D	VPD3019 (a) tai T6631 DD14292
3650	6359T	VPD3019 (a) tai T6631 DD14292

a - AC Delco/Sofabex tyyppi

22.10.2010



## SUUTIN

### SD27333

AR89564, AR89563, 27333

- sopii: 20-, 30-, 40- ja 50- sarjat ilman turboa

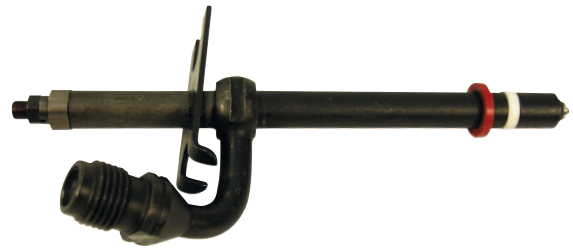

## SUUTIN

### SD27336

AR90024, AR90023, 27336

- sopii: 40- ja 50- sarjat turbolla, numeroon →753261 saakka

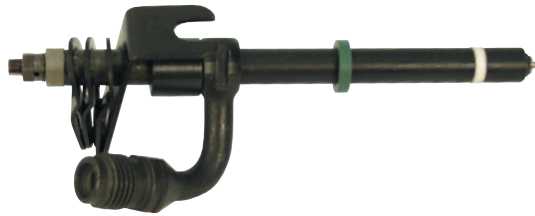

## SUUTIN

### SD60062

RE60062

- sopii: 6010, 6505, 6510

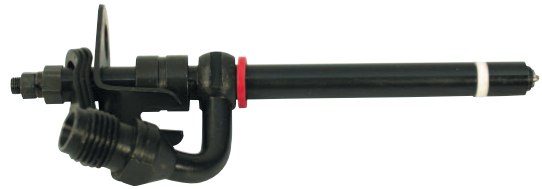

## SUUTIN

### SD48786

RE48786

- sopii: 6110, 6205, 6210, 6310, 6410, 6610, 6810, 6910

## POLTTOAINETANKIN KORKKI

### T6662

AT20911

- sopii malleihin, joissa on metallitankki



## POLTTOAINETANKIN KORKKI

### T6663

AL34678

- sopii malleihin, joissa on muovitankki



## POLTTOAINETANKIN KORKKI

### F1008

AL113086, AL113087

- 2040S, 2140, 3140, 3640, 5310, 5320, 5320N, 5415, 5420, 5420N, 5425, 5425N, 5525, 5525N, 5625, 6020, 6020SE, 6100, 6100SE, 6110, 6110SE, 6120, 6120SE, 6130, 6200, 6200SE, 6210, 6210SE, 6220, 6220SE, 6230, 6300, 6300SE, 6310, 6310SE, 6320, 6320SE, 6330, 6400, 6400SE, 6410, 6410SE, 6420, 6420SE, 6430, 6490, 6495, 6505, 6506, 6510, 6510SE, 6520, 6520SE, 6530, 6600, 6610, 6610SE, 6620, 6620SE, 6630, 6800, 6810, 6820, 6830, 6900, 6910, 6910S, 6920, 6920S, 6930, 7430, 7530



## PYSÄYTIN-SOLENOIDI

### F1001

83981012, E8NN9D278AA

- 3110, 3200, 3210, 3300, 3310, 3400, 3410, 5200, 5300, 5400, 5500, 6010, 6010SE, 6020, 6020SE, 6100, 6100SE, 6110, 6110SE, 6200, 6200SE, 6210, 6210SE, 6300, 6300SE, 6310, 6310SE, 6320, 6400, 6400SE, 6410, 6410SE, 6420, 6506, 6510, 6510SE, 6520, 6520SE, 6600, 6610, 6800, 6810, 6900, 6910, 6910SE



25.07.2008

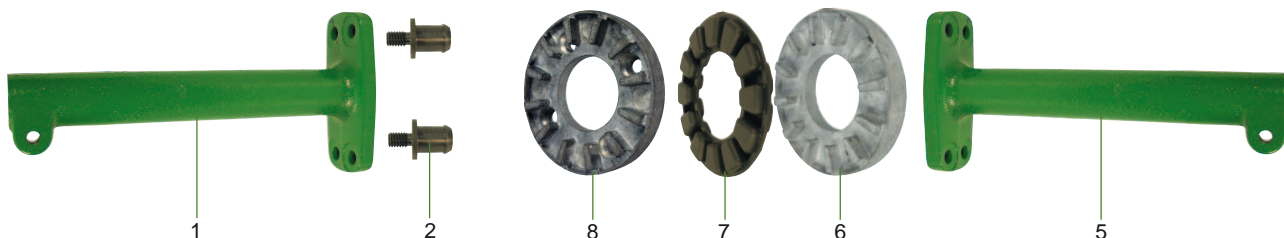

TRAKTORI-MALLI	1. KÄYTTÖ-AKSELI	2. PULTTI		
830, 930, 1020, 1030, 1130, 1830, 2020, 2030, 2120, 2130, 3020, 3030, 3120, 3130 (311079→)	<b>T6758</b> L32862 pituus 124 mm	<b>T6760</b> R34360		
3030, 3120, 3130 (→311078)	<b>T6759</b> T28263 pituus 166 mm	<b>T6760</b> R34360		

TRAKTORI-MALLI	5. KÄYTTÖ-AKSELI	6. LAIPPA	7. VÄLIKUMI	8. LAIPPA
1640, 1840, 2040, 2140, 2250, 2450, 2650, 2850	<b>T6763</b> L34572 pituus 198 mm	<b>T6766</b> L34432	<b>T6767</b> T58196 R78202	<b>T6768</b> L34569
1350, 1550, 1750, 1850	<b>T6764</b> L62258 pituus 114 mm	<b>T6766</b> L34432	<b>T6767</b> T58196 R78202	<b>T6768</b> L34569
3050, 3150, 3350, 3650	<b>T6765</b> L42187 pituus 250 mm	<b>T6766</b> L34432	<b>T6767</b> T58196 R78202	<b>T6768</b> L34569

## HYDRAULIPUMPUN KORJAUSSARJA

### VPK2204

AR98993

- sopii: 1020, 1030, 1040, 1120, 1140, 1630, 1640, 1840, 1850, 2020, 2030, 2040, 2120, 2130, 2140, 2250, 2650, 2850, 3020, 3030, 3040, 3050, 3120, 3130, 3140, 3150, 3340, 3350, 3640, 3650, 820, 830, 840, 920, 930, 940



26.09.2011

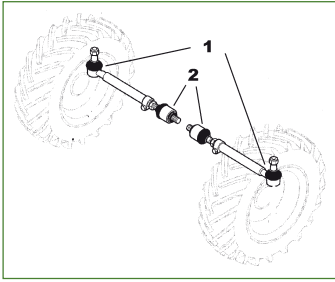

T6681



T6679



T6683



T6684



T6682

TRAKTORI-MALLI	AKSELI-TYYPPI	ULOMPI VASEN	ULOMPI OIKEA	SISEMPI VASEN	SISEMPI OIKEA
1640, 1840, 2040, 2040S, 2250, 2450		<b>T6650</b> AL39319	<b>T6650</b> AL39319	<b>T6657</b> AL39320	<b>T6657</b> AL39320
1550, 1750, 1850, 1950	APL315	<b>T6650</b> AL39319	<b>T6650</b> AL39319	<b>T6657</b> AL39320	<b>T6657</b> AL39320
2650, 2850,	APL325	<b>T6650</b> AL39319	<b>T6650</b> AL39319	<b>T6657</b> AL39320	<b>T6657</b> AL39320
2140, 2650, 2850	APL735	<b>T6650</b> AL39319	<b>T6650</b> AL39319	<b>T6657</b> AL39320	<b>T6657</b> AL39320
2140 (→024905) 2950, 3040, 3140 (→026316)	APL345		<b>T6652</b> AL39318	<b>T6658</b> AL60161	<b>T6658</b> AL60161
2140 (024906→) 3040, 3140 (026317→) 3150, 3340, 3350 6200, 6300, 6400	APL345			<b>T6658</b> AL60161	<b>T6658</b> AL60161
3040, 3140, 3050, 3350, 3640, 3650	APL350		<b>T6656</b> AL68255		
3040, 3050, 3140, 3150, 3350, 3640, 3650	APL345 HD				
6100, 6200, 6100SE, 6200SE, 6300SE, 6400SE	APL2025	<b>T6678</b> AL110957 AL80538	<b>T6679</b> AL110956 AL80537	<b>T6680</b> AL80541	<b>T6680</b> AL80541
6300, 6400, 6010, 6110, 6210, 6310, 6410 + SE-mallit, 6506, 6510, 6600, 6610, 6800, 6810	APL2035	<b>T6683</b> AL116740	<b>T6684</b> AL116741	<b>T6685</b> AL80542	<b>T6685</b> AL80542
6506, 6600, 6800, 6510, 6610, 6810 + SE-mallit	APL2045	<b>T6683</b> AL116740	<b>T6684</b> AL116741	<b>T6685</b> AL80542	<b>T6685</b> AL80542
6900, 6910	APL2060	<b>T6681</b> AL110923 AL119279	<b>T6681</b> AL110923 AL119279	<b>T6682</b> AL110918	<b>T6682</b> AL110918



F3946561



F0593

TRAKTORIMALLI	AKSELITYYPPI	OLKATAPPI
1550, 1750, 1850, 1950	ZF APL315	<b>F3946561</b> L40036
1850N, 1950N	ZF APL315N	<b>F3946561</b> L40036
1640 (a), 2040 (a), 2040S (a), 1550, 1750, 1850, 1950	ZF APL325	<b>F3946561</b> L40036
1850N, 1950N, 2650N	ZF APL325N	<b>F3946561</b> L40046
2140 (a), 2750, 2950, 2955, 3040 (a), 3050, 3140 (a), 3150, 3155, 3350, 3640, 3650	ZF APL345 ZF APL350	<b>F0592</b> L40004
940, 1040, 1140, 1640 (b), 1840 (b), 2040 (b), 1550 (c), 1750 (c)	ZF APL1351	<b>F0593</b> L35606

a - 450000→

b - →449999

c - →629999

**J1.24**

Alkuperäisnumerot ovat ainoastaan vertailua varten, eivätkä tarkoita, että tuotteet ovat alkuperäisiä.  
Täulukkoissa esiintyvät kuvat ovat viitteellisiä.

08.01.2007



Sarja sisältää: laakerit, aurinkopyörä, planeettapyörät, kehäpyörä, lukkorenkaat

## T20082

- APL 325
- JD 1640, 1850, 1950, 2040, 2250, 2450, 2650

## T20088

- APL 345
- JD 3050, 3350

## T20090

- APL 350
- JD 3050, 3350, 3650





25.07.2008



VPJ3076

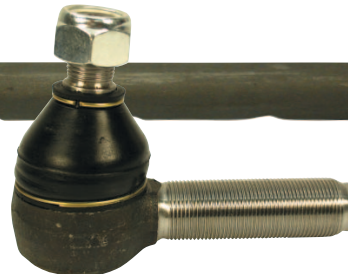

VPJ3073



VPJ2636

TRAKTORIMALLI	SISEMPI RAIDE- TANGON PÄÄ	ULOMPI RAIDE- TANGON PÄÄ	KESKI- TAPIN LAAKERI		
<b>4-sylinteriset</b> 1830, 2030, 2130	<b>VPJ3073</b> AL37504	<b>VPJ3076</b> AL37505			
<b>1640, 1840, 2040, 2040S, 2140</b>	<b>VPJ3073</b> AL37504	<b>VPJ3076</b> AL37505			
<b>2250, 2450, 2650, 2850</b>	<b>VPJ3073</b> AL37504	<b>VPJ3076</b> AL37505			
<b>6-sylinteriset</b> 3120 (j), 3030, 3130			<b>VPJ2636</b> JD8827		

j - 063362→

26.09.2011

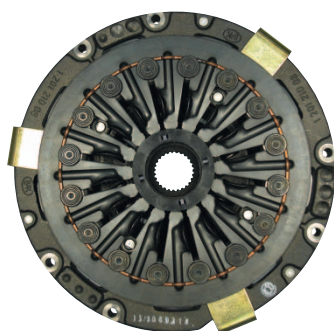

LUK133060210

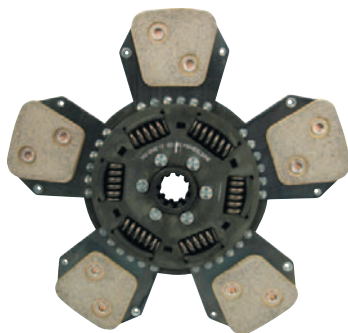

LUK333004210



LUK510002110



LUK500020420



L6202-2RS

TRAKTORI-MALLI	KOKO JA TYYPI	ASETELMA	AJO-KYTKIN-LEVY	TÄYD. PAINE-LAAKERI (m)	PAINE-LAAKERI (k)	SILMÄ-LAAKERI
1020, 1030, 1040, 1140 820, 830, 840, 920, 940	Kaksois 280 x 225 mm		LUK328006111 (p) VPG2144 (o) AL23511		LUK500020420 (a) AL30777	L6202-2RS JD10107
1630, 1640, 1840 1120, 1130	Kaksois 280 x 225 mm		LUK328006111 (p) VPG2144 (o) AL23511		LUK500020420 (a) AL30777	L6202-2RS JD10107
2020, 2030, 2040, 2120, 2240	Kaksois 280 x 225 mm		LUK328006111 (p) VPG2144 (o) AL23511		LUK500020420 (a) AL30777	L6202-2RS JD10107
840, 940, 1020, 1030, 1040, 1120, 1130, 1140 (→49515)	Yksöis 280 mm (b)	LUK128002920 (c, 3) AL39618	LUK328006111 (p) VPG2144 (o) AL23511		LUK500020420 (a) AL30777	L6202-2RS JD10107
1530, 1630, 1640, 1830, 1840	Yksöis 280 mm (b)	LUK128002920 (c, 3) AL39618	LUK328006111 (p) VPG2144 (o) AL23511		LUK500020420 (a) AL30777	L6202-2RS JD10107
2130	Yksöis 300 mm (b, d)	LUK130000520 (c, 3) AL23095	LUK330001026 VPG2161 (e) AL30451		LUK500020420 (a) AL30777	L6202-2RS JD10107
2250, 2450, 2650N 1640, 1840, 2040, 2240	Yksöis 320 mm	LUK132060212 (c, 3) AL41714	VPG2218 AL56308			
2650, 2850, 3050, 3350, 3640	Yksöis 330 mm	LUK133060210 (3) AL59324 AL65891	LUK333004210 AL57415 AL61754 LUK333004212 (f)	LUK510002110 (n, q) AL66088	LUK500024811 (j) AL39541	L6202-2RS (j) JD10107
3650	Yksöis 327 mm		LUK333004210 AL62237			L6202-2RS JD10107
3040	Yksöis 330 mm	LUK133060210 (3)			LUK500024811 AL39541	L6202-2RS JD10107
3155, 3255, 3650	Yksöis 327 mm	LUK133060310 (3)	LUK333004410		LUK510002110 (q) AL66088	L6202-2RS

- a - sisältää jalan
- b - riippumattomalla voiman ulosoton kytkimellä
- c - keskiö 38,5 x 23 pooria
- d - ilman HI-LO-vaihteistoa
- e - 15-poorinen
- f - kudottu levy orgaani
- j - ei malleihin, joissa SG2-ohjaamo

- k - mekaaninen kytkimen käyttö
- m - hydraulinen kytkimen käyttö
- n - sarjanumerosta 649119→
- o - kiinteä
- p - jousitettu
- q - kasviöljypohjaiselle kytkinnesteelle
- 3 - ei levyä

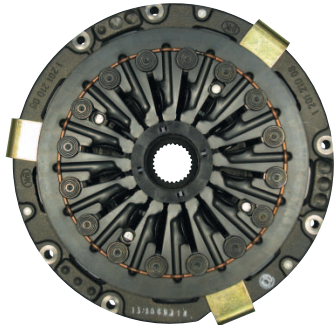

LUK133060210

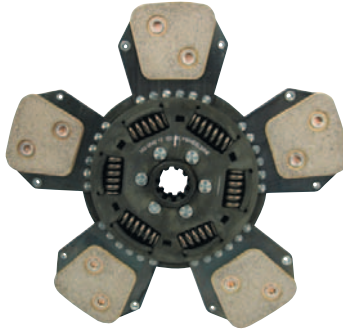

LUK333004210



LUK500024811



L6202-2RS

TRAKTORI-MALLI	KOKO JA TYYPPI	ASETELMA	AJOKYTKIN-LEVY	PAINE-LAAKERI	SILMÄ-LAAKERI
2130, 3030, 3120, 3130	Yksöis 300 m (d)	LUK130000420 (e, 3) AL28039	LUK330000911 VPG2159 (f) AL30452 LUK330000910	LUK500020420 (a) AL30777	L6202-2RS JD10107
2040S, 2140 (→416039L)	Yksöis 320 mm	LUK133060210 (e, 3) AL33127	LUK332000127 AL33126	LUK500020420 (a) AL30777	L6202-2RS JD10107
2040S, 2140 (416040L→) 3040, 3140	Yksöis 330 mm (b, k)	LUK133060210 (e, k, 3) AL59324 AL65891	LUK333004210 (h) AL57415 AL61754 LUK333004212 (j, m)	LUK500024811 (l) AL39541	L6202-2RS (l) JD10107
2020, 2030, 2120 2130, 2240, 2040, (→463068)	Yksöis 280 mm (b)	LUK128002920 (c, 3) AL39618	VPG2144 (o) AL23511 LUK328006111 (p)	LUK500020420 (a) AL30777	L6202-2RS JD10107
1040, 1140, 1640	Yksöis 330 mm	LUK133060210 (e, k, 3) AL59324 AL65891	LUK333004210 (l) AL57415 AL61754 LUK333004212 (j, m)	LUK500024811 (l) AL39541	L6202-2RS (l) JD10107
1840, 2040, 2240	Yksöis 330 mm	LUK133060210 (e, k, 3) AL59324 AL65891	LUK333004210 (l) AL57415 AL61754 LUK333004212 (j, m)	LUK500024811 (l) AL39541	L6202-2RS (l) JD10107
1350, 1550, 1750, 1850, 1850N 1950, 1950N	Yksöis 320 mm	LUK132060212 (c, 3) AL41714	LUK328016726 VPG2292 AL39123 (280 mm)		
Puimurit 330, 430, 925, 935, 945, 930, 940	Yksöis 10"		T4083		

- a - täydellinen
- b - riippumattomalla voiman ulosoton kytkimellä
- c - keskiö 38,5 x 23 pooria
- d - HI-LO-vaihteistolla
- e - keskiö 45 mm x 27 pooria
- f - 10 pooria
- h - 5-lapainen keraaminen
- j - orgaani
- k - asennettaessa tämä suurempi halkaisijainen kytkin, on vauhtipyörässä oleva tila suurennettava 331 mm suuruiseksi
- l - ei sovi malleihin joissa SG2-ohjaamo
- m - kudottu levy
- o - kiinteä
- p - jousitettu
- 3 - ei levyä

## ULOSOTTOAKSELI

### T6708

L110178, L151598  
- sopii: 6000- ja 7000-sarjat

08.05.2009

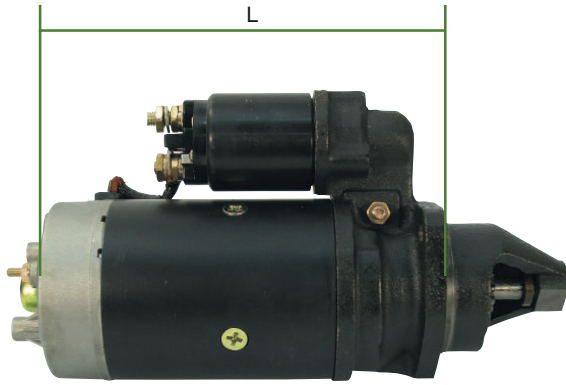

## STARTTIMOOTTORI

### ST0218

- 000.367.075.078, LRS, AR70436
- 10-hampainen
- 3,0 kW
- Bosch-tyyppi
- L-mitta = 255 mm
- sopii: 20-, 30-, 40- ja 50-sarja
- varaosa-bendix **ST1032**



## STARTTIMOOTTORI

### ST0230

- 10-hampainen
- 2,7 kW
- Iskra
- L-mitta = 230 mm
- sopii: 20-, 30-, 40- ja 50-sarja



## SOLENOIDI

### ST0171

- AL19192, AL25268, AL55046
- sopii Bosch-tyypin startteihin



## STARTTIMOOTTORIN HIILISARJA

### VPF2610

- AL55046



## VIRTALUKKO

### ST0211

- AL35864
- 1040, 1140, 1350, 1550, 1640, 1750, 1840, 1850, 1950, 2040, 2040S, 2140, 2250, 2450, 2650, 2850, 3040, 3050, 3140, 3350, 3640, 3650, 840, 940
- P-0-1-2-3



## TYÖVALO

### T6638

- sopii: 6000, 6010, 7000 ja 7010-sarjoihin

## VILKKURELE

### ST0260

- AL32891
- 1020, 1030, 1040, 1120, 1130, 1140, 1350, 1550, 1630, 1640, 1750, 1830, 1840, 1850, 1950, 2020, 2030, 2040, 2040S, 2120, 2130, 2140, 2250, 2450, 2650, 2850, 3030, 3040, 3050, 3130, 3140, 3350, 3640, 3650, 840, 940



25.07.2008



T6625



T6620



T6729



T6730



T6629



T6628

TRAKTORI-MALLI	ETU-UMPIO	KUORI VASEN	KUORI OIKEA	KIINNIKE-SARJA	KEHYS
830, 930, 1030, 1130, 1630, 1830, 2030, 2130, 3030, 3130, 940, 1040, 1140, 1640, 2040, 2040S, 2140, 3040, 3140, 3640, 4040S, 4240S	<b>T6625</b> DE12298	<b>T6626</b> R60139	<b>T6627</b> R60138	<b>T6629</b> B18402	<b>T6628</b> R60135
840, 4640, 4840	<b>T6625</b> DE12298	<b>T6729</b> L56462	<b>T6730</b> L56463		<b>T6628</b> R60135
840, 940, 1040, 1140, 1350, 1640, 1850F, 1950F, 2040, 2040S, 2140, 2250F, 2450F, 2650F, 3040, 3140, 3150, 3640, 2640S, 1550, 1750, 1850, 1850N, 1950, 1950N, 2250, 2450, 2650, 2650N, 2850, 3050, 3350, 3650	<b>T6620</b> H4	<b>T6729</b> L56462	<b>T6730</b> L56463		
4050, 4055, 4250, 4255, 4450, 4455, 4555, 4650, 4755, 4850, 4955	<b>T6620</b> H4				
6100, 6200, 6300, 6400, 6506, 6600, 6800, 6900, 6110, 6210, 6310, 6410, 6510, 6610, 6810, 6910, SE6010, SE6110, SE6210, SE6310, 7600, 7700, 7800, 7610, 7710, 7810	<b>T6757</b> AL75338 RE56964				

## ETUÄÄRIVALO OIKEA / VASEN

### T2376

- sopii 30- ja 40-sarjoihin
- polttimot: 1 x P12814, 1 x P12498
- varalasi T2377



## VILKKU-ÄÄRIVALO ETEEN

- sopii 50-sarjaan
- sopivat polttimot: 1 x P12498 ja 1 x P12814

**Vasen**  
T2372

**Oikea**  
T2373



## TAKA-VALO

- sopii: 20-30-40-sarjoihin, sekura-ohjaamo
- polttimot: 1 x P12814, 2 x P12498

**Vasen**  
F1941207  
- varalasi  
F1941210

**Oikea**  
F1941208  
- varalasi  
F1941209



## TAKA-VALO

- sopii: 1040, 1140, 1350, 1550, 1640, 1750, 1840, 1950, 2040, 2040S, 2140, 2250, 2450, 2650, 2850, 3040, 3050, 3140, 3350, 3640, 3650, 840, 940
- koko: 158 x 65 x 52
- polttimot 1 x P12814, 2 x P12498

**Vasen**  
T6921  
AL64947

**Oikea**  
T6920  
AL64946



## TAKA-VALO

- sopii: 20-30-40-sarjoihin
- polttimot: 1 x P12814, 2 x P12498

**Vasen**  
T2384  
- varalasi T2386

**Oikea**  
T2385  
- varalasi T2387





25.07.2008

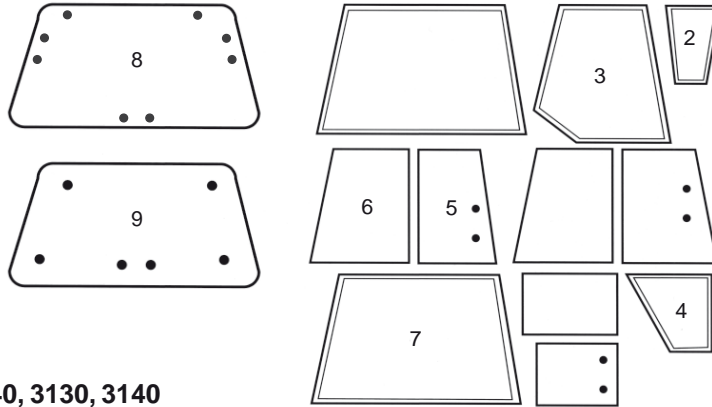

## Sekura-ohjaamo

1640, 2030, 2040, 2130, 2140, 3030, 3040, 3130, 3140

TUOTE-NRO	LASI	KUVAUS	ALKUPERÄIS-NUMERO	KOKO mm (k ork. x lev. x vahv.)	VÄRI	KIINNITYS
2	<b>T20051</b> (a, d)	Alempi etu	oik., kehyksellä	AL27353	630 x 280	kirkas K
2	<b>T20052</b> (a, e)	Alempi etu	vas., kehyksellä	AL27352	630 x 280	kirkas K
3	<b>T20053</b> (a, g)	Ylempi oven	oik., kehyksellä	AL27355	800 x 740	kirkas K
4	<b>T20055</b> (a, h)	Alempi oven	vas., kehyksellä avattava	L32953	670 x 385 x 5	kirkas K
6	<b>T20057</b> (a)	Sivulasi	vas. & oik., kiinteä	L32954	675 x 460 x 5	kirkas K
7	<b>T6731</b> (b)	Ylempi taka	kehyksellä	AL28056	1150 x 675	kirkas K
8	<b>T6608</b>	Ylempi taka	ilman kehystä		1189 x 709	kirkas R
9	<b>F0486</b>	Ylempi taka	ilman kehystä		1177 x 640	kirkas R

a - → 199830  
b - 212716→

d - sävytetyn lasin alkuperäisnumero AL25757  
e - sävytetyn lasin alkuperäisnumero AL25756

g - sävytetyn lasin alkuperäisnumero AL25759  
h - sävytetyn lasin alkuperäisnumero AL25760  
i - sävytetyn lasin alkuperäisnumero AL25761



## MC1 ja CC2 ohjaamot

1040, 1140, 1550, 1640, 1850, 1950, 2040, 2250, 2450, 2650, 2850

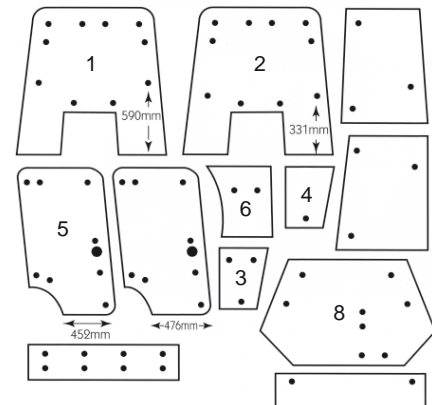

TUOTE-NRO	LASI	KUVAUS	ALKUPERÄIS-NUMERO	KOKO mm (k ork. x lev. x vahv.)	VÄRI	KIINNITYS
1	<b>T6732</b> (e)	Tuulilasi	10 reikää	L57290	1248 x 1085 x 6	kirkas R/PK
2	<b>T6733</b> (f)	Tuulilasi	10 reikää	L59466	1248 x 1085 x 6	kirkas R/PK
3	<b>T6734</b> (e)	Alempi etu	vas. & oik., 3 reikää	L57280	375 x 325 x 5	kirkas PK
4	<b>T6735</b> (f)	Alempi etu	vas. & oik., 1 reikä	L60319	375 x 325 x 5	kirkas PK
5	<b>T6736</b> (a, b)	Ylempi oven	vas. & oik., 9 reikää	L63914	1210 x 750 x 5	kirkas R/PK
6	<b>T6737</b> (c)	Alempi oven	vas. & oik., 2 reikää	L63916	442 x 395 x 5	kirkas PK
8	<b>T6605</b>	Ylempi taka	8 reikää	L57284	1180 x 810 x 5	kirkas R/PK

a - 4-sylinteriset mallit  
b - korvaa alkuperäisnumeron L57908  
c - korvaa alkuperäisnumeron L57909

e - → 003481  
f - 003482→

Kiinnitystavat: L = liimattu  
PK = pulttikiinnitys  
K = kehyksellä  
T = tiivisteellä  
R = reunasuojalla

### J1.30

Alkuperäisnumerot ovat ainoastaan vertailua varten, eivätkä tarkoita, että tuotteet ovat alkuperäisiä. Taulukoissa esiintyvät kuvat ovat viitteellisiä.



## 6000-sarja

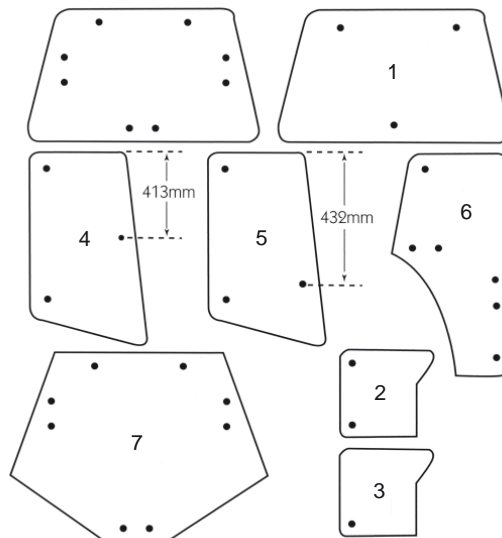

	TUOTE-NRO	LASI	KUVAUS	ALKUPERÄIS-NUMERO	KOKO mm (k ork. x lev. x vahv.)	VÄRI	KIINNITYS
1	T6745	Tuulilasi	kiinteä, 3 reikää, kaareva	L78733	1348 x 794 x 5	sävytetty	PK
2	T6746	Alempi etu	oik., 2 reikää, kaareva	L78534	620 x 480 x 5	sävytetty	PK
2	T6748	Alempi etu	vas., 2 reikää, kaareva				
3	T6747	Alempi etu	oik., 1 reikä, kaareva	L114753	620 x 480 x 5	sävytetty	PK
3	T6749	Alempi etu	vas., 1 reikä, kaareva	L114754	20 x 480 x 5	sävytetty	PK
4	T6752	Sivulasi	vas., 3 reikää, kaareva	L78537	760 x 433 x 5	sävytetty	PK
5	T6751	Sivulasi	oik., 3 reikää, kaareva	L113305	760 x 433 x 5	sävytetty	PK
5	T6753	Sivulasi	oik., 3 reikää, kaareva	L113306	760 x 433 x 5	sävytetty	PK
6	T6615	Oven	oik., 6 reikää, kaareva	L77648	1430 x 695 x 6	sävytetty	PK
6	T6614	Oven	vas., 6 reikää, kaareva	L77647	1430 x 695 x 6	sävytetty	PK
7	T6613 (a)	Takalasi	8 reikää, kaareva	L78727	1250 x 760 x 6	sävytetty	R/PK

a - ei sovi malleihin 6520 ja 6620

## 7000-sarja

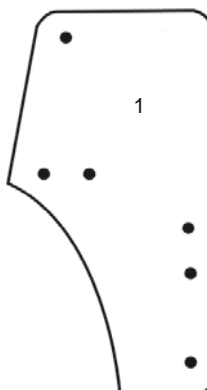

	TUOTE-NRO	LASI	KUVAUS	ALKUPERÄIS-NUMERO	KOKO mm (k ork. x lev. x vahv.)	VÄRI	KIINNITYS
1	T6754 (a)	Oven	oik., 6 reikää, kaareva	R131164	1430 x 700 x 6	sävytetty	PK
1	T6755 (b)	Oven	vas., 6 reikää, kaareva	R131163	1430 x 700 x 6	sävytetty	PK

a - korvaa alkuperäisnumeron R110825

b - korvaa alkuperäisnumeron R96191

Kiinnitystavat: L = liimattu  
 PK = pulttikiinnitys  
 K = kehyksellä  
 T = tiivisteellä  
 R = reunasuojalla

22.10.2010

## SG2-ohjaamo

1640, 2040, 2140, 3040, 4040, 4040S, 4240, 4240S  
 4030, 4230, 4430, 4630, 8430, 8630  
 1350, 1550, 1750, 1850, 1950, 2150, 2250, 2450,  
 2550, 2650, 2750, 2850,  
 2950, 3050, 3150, 3350, 3650, 4050, 4250, 4350,  
 4450, 4650, 4850  
 4055, 4255, 4455, 4555, 4755, 4955

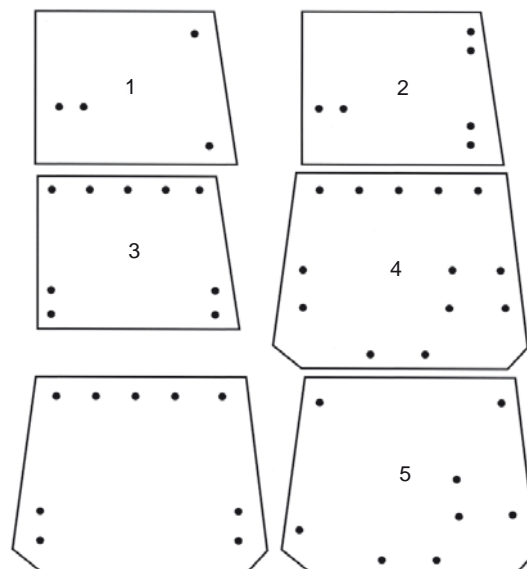

	TUOTE-NRO	LASI	KUVAUS	ALKUPERÄIS-NUMERO	KOKO mm (k ork. x lev. x vahv.)	VÄRI	KIINNITYS
1	<b>T6741</b> (c)	Sivulasi	vas. & oik., 4 reikää	L55037	905 x 653 x 6	sävytetty	R/PK
1	<b>T6743</b> (c)	Sivulasi	vas. & oik., 4 reikää	L57977	923 x 765 x 6	sävytetty	R/PK
2	<b>T6742</b>	Sivulasi	vas. & oik., 6 reikää	L55040	917 x 753 x 6	sävytetty	R/PK
3	<b>T6744</b> (d)	Sivulasi	vas. & oik., 9 reikää	R50757	918 x 760 x 6	sävytetty	R/PK
4	<b>T6606</b> (c)	Takalasi	13 reikää	L36606	833 x 1265 x 6	sävytetty	R/PK
5	<b>T6607</b> (b)	Takalasi	8 reikää	AL70847	825 x 1258 x 6	sävytetty	R/PK

b - korvaa alkuperäisnumeron L57978

c - 40-sarjan malleihin sopivat ainoastaan lasit 1 ja 4

d - 55-sarjan malleihin sopii ainoastaan lasi 3

Kiinnitystavat: L = liimattu  
 PK = pulttikiinnitys  
 K = kehyksellä  
 T = tiivisteellä  
 R = reunasuojalla



## TUULILASILIMASARJA

### HK269

- annostellaan kylmänä, valumaton
- max. kiinnitysaika 25 min
- ajovalmuisaika 2 h
- sisältö: puhdistusaine 20 ml, puhdistusliina, primer 10 ml, primer-levitin, liima 310 ml

25.07.2008



## LÄMMITYSLAITTEEN MOOTTORI

### T4161

- sopii: 1040, 1140, 1640, 2040, 2140
- Sekura-ohjaamo

## LÄMMITYSLAITTEEN MOOTTORI

- sopii: 1550, 1750, 1850, 1950, 2250, 2450, 2650, 2850
- MC1-ohjaamo

**Vasen**  
**T5155**

**Oikea**  
**T5156**

## LÄMMITYSLAITTEEN MOOTTORI

### T6630

- täydellinen puhallin
- 2 kpl/ohjaamo
- sopii: 40- ja 50-sarja SG2-ohjaamot
- sopii: 6110, 6210, 6310, 6410, 6510, 6610, 6810, 6910

## OVEN ULKOKAHVA

### VLD1443

AL25947

- sopii: 30 ja 40-sarja, OPU-hytti



Jarrulevy

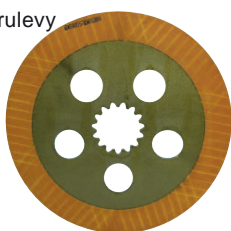

malli 1

Jarrulevy

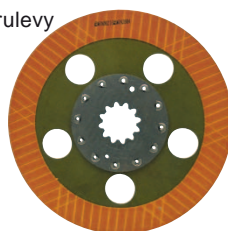

malli 2

Jarrumäntä



malli 3

TRAKTORI-MALLI	MALLI	TUOTE-NUMERO	MITAT
840, 940, 1040, 1140, 1350, 1550, 1640, 1750, 1750V, 1840, 1850, 1850F, 1850V, 1950, 1950F, 1950N, 2040, 2250, 2250F, 2450, 2450F, 2650, 2650F, 2850	2	<b>T6666</b> AL65872	Ø 306 mm 12Z, vahv. 4,9 mm
6010, 6100(SE), 6101SE, 6110(SE), 6200(SE), 6205, 6210(SE), 6300(SE), 6310(SE), 6400(SE), 6410(SE), 6505, 6506, 6510(SE), 6600, 6610(SE)	2	<b>T6667</b> AL111498 AL75434	Ø 313 mm 14Z, vahv. 4,9 mm
6010, 6100(SE), 6106(SE), 6110(SE), 6200(SE), 6210(SE), 6300(SE), 6310(SE), 6400(SE), 6410(SE), 6506, 6510(SE), 6600, 6610(SE)	2	<b>T6668</b> AL112982	Ø 313 mm 14Z, vahv. 5,9 mm
3040, 3140, 3340, 3640, 3640S	3	<b>T6669</b> L40395	vahv. 50 mm
840, 940, 1040, 1140, 1350, 1550, 1640, 1750, 1840, 1850, 1850F, 1950, 1950F, 1950N, 2040, 2040S, 2250, 2650, 2650F, 2650N, 2450, 2850	3	<b>T6670</b> L63944 L60890	vahv. 41 mm
3050, 3150, 3350, 3650	3	<b>T6671</b> L65164, L60889 L63946	vahv. 48,5 mm
830, 930, 1030, 1130, 1630, 1830, 2030, 840, 940, 1040, 1140, 1640, 1840, 2040, 1150, 1750, 1850, 1950, 1950N, 2250, 2450	1	<b>T6640</b> AL38234	Ø 306 mm Z12, vahv. 7 mm
2130, 3030, 3130, 1640, 2040, 2040S, 2140, 3040, 3140, 3340, 3640, 2250, 2450, 2650, 2650N, 2850, 3050, 3150, 3350, 3650	1	<b>T6641</b> AL38235	Ø 306 mm Z15, vahv. 10 mm
820, 920, 1020, 1120, 2020, 2120, 830, 930, 1030, 1130, 1630, 1830, 2030, 2130, 1640, 2040, 2040S, 2140	1	<b>T6642</b> AZ40478	Ø 306 mm Z12, vahv. 10 mm

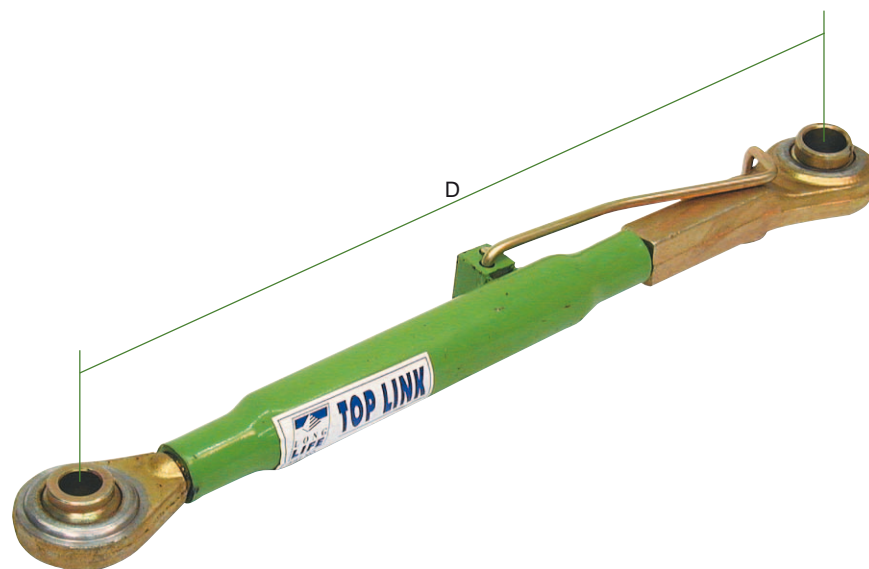

TRAKTORI-MALLI	TUOTE-NUMERO	PÄÄT mm	SÄÄTÖVARA (D) min. mm    max. mm	PAINO kg
Sopii muihin JD-malleihin paitsi 3130, 3140 ja 3040	T6600	20-25,4	550            760	6

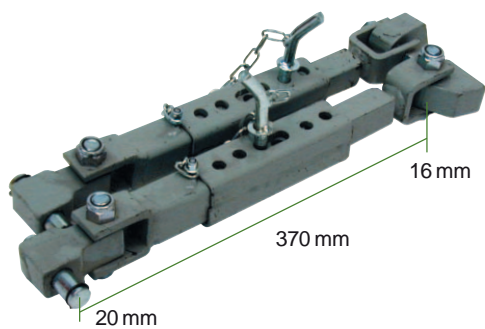

SIVURAJOITINPARI
<b>T0384</b> - 4-syl. 1630 - 2140 - 6-syl. 3040 - 4440 - sisäosa 30 x 30 mm - sokkatappi 12 mm

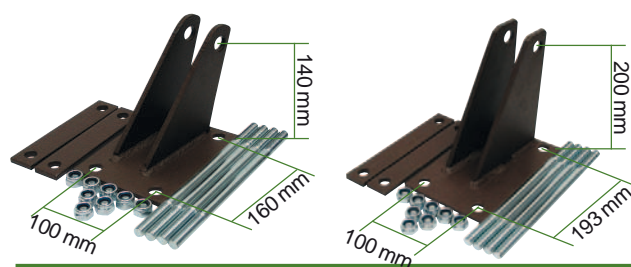

KORVAKESARJA JD			
- JD1630, 2140 matala		- JD3040, 4440 korkea	
- kierretangot M16x200			
<b>Vasen</b>	<b>Oikea</b>	<b>Vasen</b>	<b>Oikea</b>
<b>T0441</b>	<b>T0442</b>	<b>T0443</b>	<b>T0444</b>

26.09.2011



TRAKTORIMALLI	ETUSULKA	TAKASULKA
1030, 1130, 1630, 2030, 2130, 3030, 3130 40-sarja FSC-ohjaamo, 940, 1040, 1140, 1640, 1840, 2040, 2040S, 2140, 3040, 3140 (→372024)	VLC3221 350 mm	
MC 1 -ohjaamo 940, 1040, 1140, 1640, 2040, 2040S, 1550, 1750, 1850, 1950, 2250, 2450, 2650, 2850	VLC3225 460 mm	
Uusi CC 2 -ohjaamo 1550, 1750, 1850, 1950, 2250, 2450, 2650, 2850	VLC3225 460 mm	
SG2-ohjaamo 1640, 2040, 2040S, 2140, 3040, 3140, 3640, 2250, 2450, 2650, 2850, 3050, 3350, 3650	VLC3228 L/R 510 mm	VLC3228 510 mm
SG2-ohjaamo 4230, 4430, 4630, 8430, 8630, 4040, 4040S, 4240, 4240S, 4440, 4640, 4840, 8440, 8640, 4050, 4250, 4450, 4650, 4850, 8450, 8650, 8850		VLC3228 510 mm

## STOP-VAIJERI

### MF0833

AL36923

- 1550, 1750, 1850, 1950, 1950N  
- pituus 1,3 m

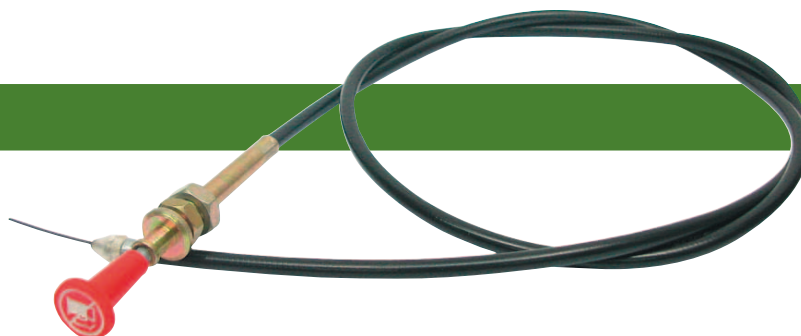

J1.35



TRAKTORI-MALLI	OHJAAMO-TYYPPI	TAKALASIN SYLINTERI	KATTO-LUUKUN SYLINTERI	OVEN SYLINTERI	ETULASIN SYLINTERI
940, 1040, 1140, 1640, 2040, 2040S, 1550, 1750, 1850, 1950, 2250, 2450, 2650, 2850	MC1		T2336 KS0111 L57248	VPM1653 KS0139 AL63124	VPM1620 KS0136 AL61021
940, 1040, 1140, 1640, 2040, 2040S, 2140, 3040, 3140	OPU cab	MF0134 KS0101 AL33170	T6602 KS0129 AL28599		
730, 830, 930, 1030, 1130, 1630	Sekura SEK 927		T6604 KS0131 AL28649		
2030, 2130, 3030, 3130	Sekura SEK 294	T6602 KS0129 AL28599	T6602 KS0129 AL28599		
1830, 2030, 2130	Sekura SEK 293	T6602 KS0129 AL28599	T6604 KS0129 AL28649		
1030, 1130, 1630	Sekura SEK 442		T6602 KS0129 AL28599		
1030, 1130, 1630	OPU cab	VPM1710 KS0148 AL30141	T6602 KS0129 AL28599		
Kaikki mallit SG2-ohjaamalla 1640, 2140, 3040, 3140, 2250, 2450, 2650, 2850, 3050, 3350, 3650	SG2	T6603 KS0130 AL35675	T6602 KS0129 AL28599		



26.09.2011

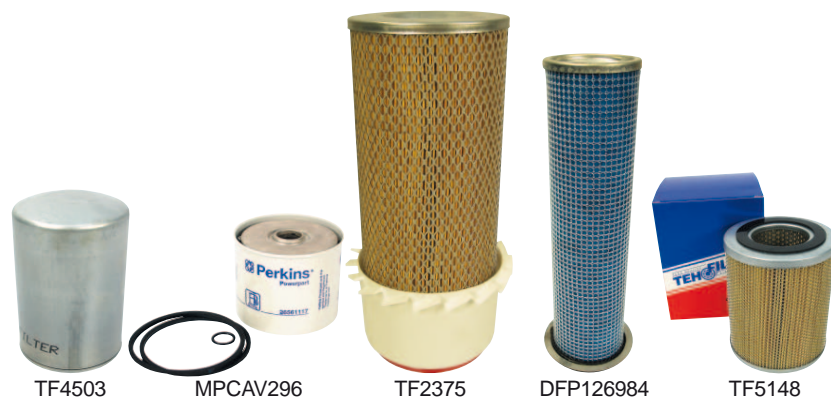

TF4503

MPCAV296

TF2375

DFP126984

TF5148

TRAKTORI-MALLI	MOOTTORI-TYYPPI	ÖLJYN-SUODATIN	POLTTO-AINE-SUODATIN	ILMANSUODATTIMET		HYDRAULIIKKA-SUODATIN
				ULOMPI	SISEMPI	
830, 930, 1020, 1030, 1120, 1130	3164D	TF4503 DFP550020 T19044	MPCAV296 DFP556245 AT17387 DFP551130 AR50041	TF21001 (c) DFP181052 AT20728 TF2375 (d) AR84228	DFP126984 (d) AL27159	TF5148 (o) AR75603 T6612 (o) AL25554
840, 940 1040, 1140	3179D	TF4503 DFP550020 T19044	DFP551130 AR50041	TF2375 AR84228	DFP126984 AL27159	TF5148 AR75603 (140 mm)
1630	3179D	TF4503 DFP550020 T19044	DFP551130 AR50041	TF21001 (c) DFP181052 AT20728 TF2375 (d) AR84228	DFP126984 (d) AL27159	TF5148 (o) AR75603 T6612 (o) AL25554
1350, 1550, 1750 1850, 1850N 1950, 1950N		TF4503 DFP550020 T19044	DFP551130 AR50041	TF2375 (e) AR84228 TF2198 (f) DFP181088 AZ20623	DFP126984 (e) AL27159 VPD7066 (f) AL58730	TF5148 AR75603 T6610 (i) AL56469
1830, 2020, 2030 2120, 2130, 3020		TF4503 DFP550020 T19044	MPCAV296 DFP556245 AT17387 DFP551130 AR50041	TF21001 (c) DFP181052 AT20728 TF2375 (d) AR84228	DFP126984 (d) AL27159	TF5148 (o) AR75603 T6612 (o) AL25554
1640, 1840 2040, 2040S	4239D	TF4503 DFP550020 T19044	DFP551130 AR50041	TF2375 AR84228	DFP126984 AL27159	TF5148 AR75603 (140 mm)
2140, 3040		TF4503 DFP550020 T19044	DFP551130 AR50041	TF2376 AL30394	TF2376-2 AL30395	TF5148 AR75603 (140 mm)
2250, 2450 2650, 2650N	4239D	TF4503 DFP550020 T19044	DFP551130 AR50041	TF2198 DFP181088 AZ20623 TF2375 (n) AR84228	VPD7066 AL67195 DFP126984 (n) AL27159	TF5148 AR75603 T6610 (i) AL56469
2750, 2850, 2950		TF4503 DFP550020 T19044	DFP551130 AR50041	TF2376 AL30394 TF2198 DFP181088 AZ20623	TF2376-2 AL30395 VPD7066 AL67195	TF5148 AR75603 T6610 (i) AL56469
2150, 2350, 2550		TF4503 DFP550020 T19044	DFP551130 AR50041	TF2375 AR84228	DFP126984 AL27159	TF5148 AR75603 T6610 (i) AL56469
3120, 4020		TF4503 DFP550020 T19044	MPCAV296 DFP556245 AT17387 DFP551130 AR50041	TF21001 (c) DFP181052 AT20728 TF2375 (d) AR84228	DFP126984 (d) AL27159	TF5148 (o) AR75603 T6612 (o) AL25554
3030 3130	6329D	TF4503 DFP550020 T19044	DFP551130 AR50041	TF2375 AR84228 DFP771562 AL27158	DFP126984 AL27159 DFP770908 AL27160	TF5148 (o) AR75603 T6612 (o) AL25554

Katso huomautukset sivulta J1.39

**J1.37**

Alkuperäisnumerot ovat ainoastaan vertailua varten, eivätkä tarkoita, että tuotteet ovat alkuperäisiä. Taulukoissa esiintyvät kuvat ovat viitteellisiä.

01.12.2009



TF4503

MPCAV296

TF2375

DFP126984

TF5148

TRAKTORI-MALLI	MOOTTORI-TYYPPI	ÖLJYN-SUODATIN	POLTTO-AINE-SUODATIN	ILMANSUODATTIMET ULOMPI	SISEMPI	HYDRAULIIKKA-SUODATIN
3140	6359D	TF4503 DFP550020 T19044	DFP551130 AR50041	TF2376 AL30394 DFP771533 (I) AR79941	TF2376-2 AL30395 DFP136401 (I) AR79942	TF5148 AR75603 (140 mm)
3050, 3350	6359D	TF4503 DFP550020 T19044	DFP551130 AR50041	TF2198 DFP181088 AZ20623	VPD7066 AL67195	TF5148 AR75603 T6610 (I) AL56469
3640		TF4503 DFP550020 T19044	DFP551130 AR50041	TF2376 AL30394	TF2376-2 AL30395	TF5148 AR75603 T6610 (I) AL56469
3650	6359T	TF4503 DFP550020 T19044	DFP551130 AR50041	TF2197 DFP771561 AZ30757	TF2376-2 AL61764	TF5148 AR75603 T6610 (I) AL56469
4030		TF4503 DFP550020 T19044	DFP551130 AR50041	DFP771533 AR79941	DFP136401 AR79942	TF5148 AR75603
4040 4040S	6359T	TF4503 DFP550020 T19044	DFP551130 AR50041	DFP771533 AR79941	DFP136401 AR79942	
4230, 4240			DFP551130 AR50041	DFP771533 AR79941	DFP136401 AR79942	TF5148 AR75603 (140 mm)
4050, 4250, 4350, 4450						DFP164381 AL77061
4320			DFP551130 AR50041			TF5148 AR75603
4430			DFP551130 AR50041			TF5148 AR75603 (140 mm)
4440			DFP551130 AR50041			
4520, 4620			DFP551130 AR50041			TF5148 AR75603
4630						TF5148 AR75603 (140 mm)
4640, 4840			DFP551130 AR50041			

Katso huomautukset sivulta J1.39

## ÖLJYNSUODATIN

### DFP550779

RE504836, RE507522

- 3215, 3220, 3415, 3420, 3800, 5325N, 5415, 5415H, 5425, 5425H, 5425HC, 5425N, 5525, 5525N, 5603, 5615, 5620, 5625, 5625HC, 5715, 5715HC, 5720, 5725, 5725H, 5725HC, 5820, 6020, 6020SE, 6120, 6120L, 6120SE, 6215, 6220, 6220L, 6220SE, 6230, 6320L, 6320SE, 6330, 6403, 6415, 6420, 6420L, 6420S, 6420SE, 6430, 6515, 6520, 6520L, 6520SE, 6530, 6603, 6615, 6620, 6620SE, 6630, 6715, 6820, 6830, 6920, 6920S, 6930, 7220, 7320, 7420, 7430, 7520, 7530, 7630, 7720, 7730, 7815, 7820, 7830, 7920, 7930



## ÖLJYNSUODATIN

### DFP551352

RE59754

- 485E, 486E, 488E, 5415, 5415H, 5520, 5520N, 5615, 5715, 5715HC, 6010, 6010SE, 6110, 6110SE, 6205, 6210, 6210SE, 6310, 6310SE, 6405, 6410, 6410S, 6410SE, 6505, 6510, 6510S, 6510SE, 6605, 6610, 6610SE, 6810, 6910, 6910S, 7210, 7405, 7410, 7510, 7610



26.09.2011

TRAKTORI-MALLI	MOOTTORI-TYYPPI	ÖLJYN-SUODATIN	POLTTO-AINE-SUODATIN	ILMANSUODATTIMET		HYDRAULIIKKA-SUODATIN
				ULOMPI	SISEMPI	
4650, 4850			<b>DFP556745</b> AR86745			
6100, 6200, 6300, 6400	<b>TF4503</b> <b>DFP550020</b> T19044		<b>DFP550397</b> RE53400 <b>DFP551424</b> RE522868 RE62419 RE64450	<b>VPD7115</b> AL78223		<b>DFP164381</b> AL77061 <b>DFP164384</b> (p) RE34958
6600, 6800, 6900	<b>TF4503</b> <b>DFP550020</b> T19044		<b>DFP550397</b> RE53400 <b>DFP551424</b> RE522868 RE62419 RE64450		<b>VPD7116</b> AL78870	<b>DFP164381</b> AL77061 <b>DFP164384</b> (p) RE34958
7020, 7520			<b>DFP551130</b> AR50041			<b>TF5148</b> AR75603
7600	<b>TF4503</b> <b>DFP550020</b> T19044		<b>DFP550397</b> RE53400		<b>VPD7116</b> AL78870	<b>DFP164378</b> x 2 RE39527
7700, 7800			<b>DFP550397</b> RE53400 <b>DFP556745</b> AR86745		<b>VPD7116</b> AL78870	<b>DFP164378</b> x 2 RE39527
8100, 8200, 8300			<b>DFP556745</b> AR86745			
8430			<b>DFP551130</b> AR50041			<b>TF5148</b> AR75603 (140mm)
8440			<b>DFP551130</b> AR50041			
8630, 8640			<b>DFP556745</b> AR86745			<b>TF5148</b> AR75603 (140mm)
8450, 8650, 8850			<b>DFP556745</b> AR86745			
3100, 3200, 3200X, 3300, 3300X, 3400, 3400X	<b>TF4503</b> <b>DFP550020</b> T19044		<b>DFP550397</b> RE53400			
6010, 6110, 6210, 6310, 6410, 6510, 6610 + SE-mallit	<b>DFP551352</b> RE59754		<b>DFP550397</b> RE53400 <b>DFP551424</b> RE522868 RE62419 RE64450 <b>F87801341</b> (r)	<b>VPD7115</b> (t) AL78223	<b>VPD7117</b>	<b>DFP164381</b> (s) AL77061
6020, 6120, 6220, 6320, 6420, 6520 + SE-mallit	<b>DFP550779</b> RE504836 RE507522		<b>DFP550397</b> RE53400 <b>DFP551424</b> RE522868 RE62419 RE64450 <b>F87801341</b> (r)			<b>DFP164381</b> (s) AL77061
5083E+EN, 5093E+EN, 5101E, 5425+N, 5525+N, 5603, 5620, 5625, 5720, 5820, 6100D+SE, 6110D+L, 6120L, 6125D, 6200L+SE, 6210L, 6215, 6220L, 6300L+SE, 6310L+S, 6320L, 6400L+SE, 6403, 6405, 6410L+S, 6415, 6420L+S, 6500+L, 6506, 6510L+S, 6515, 6520L, 6603, 6605, 6615, 6620+SE, 6715, 6810, 6820, 6910, 6910S, 6920, 6920S, 7200, 7210, 7220, 7320, 7400, 7405, 7410, 7420, 7510, 7520, 7610, 7700, 8220, 8320, 8420, 8520, 8960, 8970			<b>DFP551424</b> RE522868 RE62419 RE64450			
7810			<b>DFP551428</b> RE508633			
6403, 6603, 9100			<b>DFP551430</b> (r)			

- c - →190319
- d - 190320→
- e - →621999
- f - 622000→
- i - paluusuodatin
- l - vaihtoehtoisesti, tehdasasenteinen turbo
- n - 634103→
- o - **TF5148** reikä 56 mm (ei Hilo)  
**T6612** reikä 56/12 mm (Hilo)
- p - 40 cm<sup>3</sup> pumpulle, pituus 240 mm
- r - ensiösuodatin
- s - spin on, pituus 151,6 mm
- t - ei mallit 6510, 6610

## ILMANSUODATIN POWERCORE

### DFP606119

- K 183, L 130, P 327 mm
- 6120, 6220, 6320, 6420, 6520, 6410, 6420



**J1.39**

Alkuperäisnumerot ovat ainoastaan vertailua varten, eivätkä tarkoita, että tuotteet ovat alkuperäisiä. Taulukoissa esiintyvät kuvat ovat viitteellisiä.

## SYKLONI ESIPUHDISTIN

Esipuhdistin säästää koneen varsinaista ilmanpuhdistinta. Syklonissa ilma joutuu pyörivään liikkeeseen ja epäpuhtaudet jäävät syklonin pohjalle. Puhdistettava ajoittain.

### DFH001249

1693129M1  
- putkikoko 3"/76 mm  
- varalasi **DFP020227**



### DFH000820

- putkikoko 3"/76 mm  
- varalasi **DFP016330**



### DFH000822

- putkikoko 4"/101 mm  
- varalasi **DFP016330**

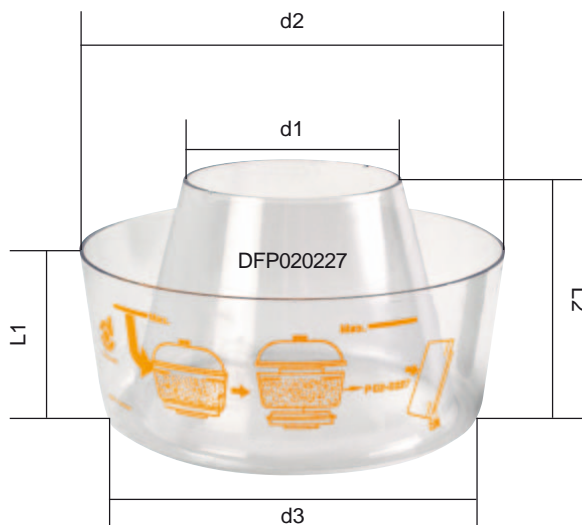
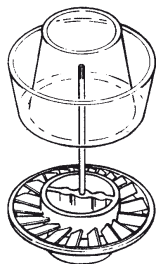

## VARALASIN MITAT

MITAT	DFP020227	DFP016330
d1 mm	90	141
d2 mm	183,5	266
d3 mm	140	217,5
L1 mm	77	75,5
L2 mm	106	101,5

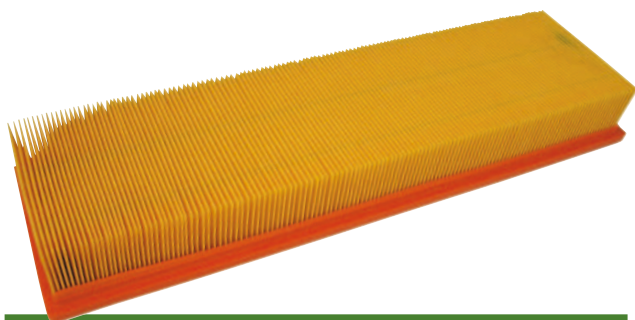

## OHJAAMON SUODATIN

### TF21099-1

- 2 kpl/ohjaamo  
- sopii SG2 ohjaamoihin



## OHJAAMON SUODATIN

### TF21099

- 2 kpl/ohjaamo  
- sopii SG2 ohjaamoihin  
- vaihtoehtoinen TF21099-1 :lle, korvaa myös muovikotelon