



TRAKTORIMALLISTA MOOTTORITYYPPIIN

TRAKTORI- MALLI	SYLINTERI- LUKU	SYLINTERI- HALKAISIJA	MOOTTORI- TYYPPI
D2506, D2807, D3006, D3607	2	100	F2L912
D4006, 4007, D4506, D4507, D4507C, D4807, D4807C, D5006, D5206, D5207, D5207C	3	100	F3L912
D5506, D6006	4	100	F4L912
D6007, D6007C	3	102	F3L913
D6206, D6207C, D6507C, D6806, D6807C, D6907C, D7006, D7007, D7007C, D7206, D7207, D7207C	4	100	F4L912
D7807	4	102	F4L913
D8006, D10006, DX6.05, DX6.10, DX110	6	100	F6L912
D13006	6	100	BF6L912
DX3.10SC, DX3.10V, DX3.30SC	3	100	F3L912
DX3.50SC	3	102	F3L913
DX3.60SC, DX3.65SC, DX3.70SC, DX4.10	4	100	F4L912
DX3.80SC, DX3.90FS, DX3.90SC, DX4.30, DX4.31	4	102	F4L913
DX4.50, DX4.51, DX4.61, DX4.70, DX4.71	4	102	BF4L913
DX6.30, DX120	6	102	F6L913
DX6.50, DX7.10, DX140, DX145, DX160	6	102	BF6L913
DX80, DX86, DX92	4	102	F4L913
DX85, DX90	5	100	F5L912
Intrac 2002	3	100	F3L912
Intrac 2003, Intrac 2004	4	100	F4L912

MOOTTORITYYPPIÄ TRAKTORIMALLIIN

MOOTTORI- TYYPPI	TRAKTORI- MALLI
2-SYLINTERISET	
F2L912	D2506, D2807, D3006, D3607
3-SYLINTERISET	
F3L912	D4006, D4007, D4506, D4507, D4507C, D4807, D4807C, D5006, D5206, D5207, D5207C, DX3.10SC, DX3.10V, DX3.30SC, Intrac 2002
F3L913	D6007, D6007C, DX3.50SC
4-SYLINTERISET	
F4L912	D5506, D6006, D6206, D6207C, D6507C, D6806, D6807C, D6907C, D7006, D7007, D7007C, D7206, D7207, D7207C, DX3.60SC, DX3.65SC, DX3.70SC, DX4.10, Intrac 2003, Intrac 2004
F4L913	D7807, DX3.80SC, DX3.90FS, DX3.90SC, DX4.30, DX4.31, DX80, DX86, DX92
BF4L913	DX4.50, DX4.51, DX4.61, DX4.70, DX4.71
5-SYLINTERISET	
F5L912	DX85, DX90
6-SYLINTERISET	
F6L912	D8006, D10006, DX6.05, DX6.10, DX110
F6L913	DX120, DX6.30
BF6L912	D13006
BF6L913	DX6.50, DX7.10, DX140, DX145, DX160

26.09.2011



VPA1400



VPA1410



VPA2023



VPA2123

TRAKTORI-MALLI	MOOTTORI-TYYPPI	IMU-VENTTIILI	PAKO-VENTTIILI	VENTTIILIJOUSI	VENTTIILIN ISTUKKARENGAS IMU
2 sylinteriset D2506	F2L912	VPA1400 04153631	VPA1410 04153697	VPA2023 03369305	VPA2123 02137302
D3006	F2L912	VPA1400 04153631	VPA1410 04153697	VPA2023 03369305	VPA2123 02137302
D2807, D3607	F2L912	VPA1400(a) 04153631	VPA1410 04153697	VPA2023 03369305	VPA2123 02137302
3 sylinteriset D4006, D4506 D5206	F3L912	VPA1400 04153631	VPA1410 04153697	VPA2023 03369305	VPA2123 02137302
D5006	F3L912	VPA1400 04153631	VPA1410 04153697	VPA2023 03369305	VPA2123 02137302
D4007, D4507 D4507C, D4807 D4807C, D5207 D5207C	F3L912	VPA1400 04153631	VPA1410 04153697	VPA2023 03369305	VPA2123 02137302
Intrac 2002	F3L912	VPA1400 04153631	VPA1410 04153697	VPA2023 03369305	VPA2123 02137302
DX3. 10SC	F3L912	VPA1400 04153631	VPA1410 04153697	VPA2023 03369305	VPA2123 02137302
DX3. 10V	F3L912	VPA1400 04153631	VPA1410 04153697	VPA2023 03369305	VPA2123 02137302
DX3. 30SC	F3L912	VPA1400 04153631	VPA1410 04153697	VPA2023 03369305	VPA2123 02137302
D6007, D6007C DX3. 50SC	F3L913	VPA1400 04153631	VPA1410 04153697	VPA2023 03369305	VPA2123 02137302
4 sylinteriset DX4.51, DX4.61 DX4.71	BF4L913	VPA1400 04153631	VPA1410 04153697	VPA2023 03369305	VPA2123 02137302
DX4.50, DX4.70	BF4L913T	VPA1400 04153631	VPA1410 04153697	VPA2023 03369305	VPA2123 02137302
D5506, D6006 D7006	F4L912	VPA1400 04153631	VPA1410 04153697	VPA2023 03369305	VPA2123 02137302
D6206, D6806 D7206	F4L912	VPA1400 04153631	VPA1410 04153697	VPA2023 03369305	VPA2123 02137302
D6207C, D6507C D6807C	F4L912	VPA1400 04153631	VPA1410 04153697		VPA2123 02137302
D6907C	F4L912	VPA1400 04153631	VPA1410 04153697	VPA2023 03369305	VPA2123 02137302
D7007, D7207, D7007C, D7207C	F4L912	VPA1400 04153631	VPA1410 04153697	VPA2023 03369305	VPA2123 02137302
Intrac 2003 Intrac 2004	F4L912	VPA1400 04153631	VPA1410 04153697	VPA2023 03369305	VPA2123 02137302

a - →6750191

b - ilman lämmitystä

K1.02

Alkuperäisnumerot ovat ainoastaan vertailua varten, eivätkä tarkoita, että tuotteet ovat alkuperäisiä.
Taulukoissa esiintyvät kuvat ovat viitteellisiä.

26.09.2011

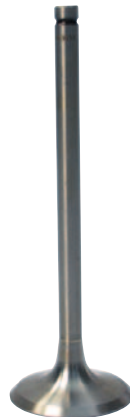

VPA1400



VPA1410



VPA2023



VPA2123

TRAKTORI-MALLI	MOOTTORI-TYYPPI	IMU-VENTTIILI	PAKO-VENTTIILI	VENTTIILI-JOUSET	VENTTIILIN ISTUKKARENGAS IMU	
4 sylinteriset jatkuu DX3.60SC	F4L912	VPA1400 04153631	VPA1410 04153697	VPA2023 03369305	VPA2123 02137302	
	DX3.65SC	F4L912	VPA1400 04153631	VPA2023 03369305	VPA2123 02137302	
	DX3.70SC	F4L912	VPA1400 04153631	VPA2023 03369305	VPA2123 02137302	
	DX4.10	F4L912	VPA1400 04153631	VPA2023 03369305	VPA2123 02137302	
	D7807	F4L913	VPA1400 04153631	VPA2023 03369305	VPA2123 02137302	
	DX80, DX86 DX92	F4L913	VPA1400 04153631	VPA2023 03369305	VPA2123 02137302	
	DX3.80SC DX3.90FS DX3.90SC	F4L913	VPA1400 04153631	VPA2023 03369305	VPA2123 02137302	
	DX4.30, DX4.31	F4L913	VPA1400 04153631	VPA2023 03369305	VPA2123 02137302	
	5 sylinteriset DX85, DX90	F5L912	VPA1400 04153631	VPA1410 04153697	VPA2023 03369305	VPA2123 02137302
		6 sylinteriset D13006	BF6L912	VPA1400 04153631	VPA1410 04153697	VPA2023 03369305
DX140, DX160 DX145	BF6L913	VPA1400 04153631	VPA1410 04153697	VPA2023 03369305	VPA2123 02137302	
DX6.50 DX7.10	BF6L913	VPA1400 04153631	VPA1410 04153697	VPA2023 03369305	VPA2123 02137302	
D8006, D10006	F6L912	VPA1400 04153631	VPA1410 04153697	VPA2023 03369305	VPA2123 02137302	
DX110	F6L912	VPA1400 04153631	VPA1410 04153697	VPA2023 03369305	VPA2123 02137302	
DX6.05, DX6.10	F6L912	VPA1400 04153631	VPA1410 04153697	VPA2023 03369305	VPA2123 02137302	
DX120	F6L913	VPA1400 04153631	VPA1410 04153697	VPA2023 03369305	VPA2123 02137302	
DX6.30	F6L913	VPA1400 04153631	VPA1410 04153697	VPA2023 03369305	VPA2123 02137302	

25.07.2008

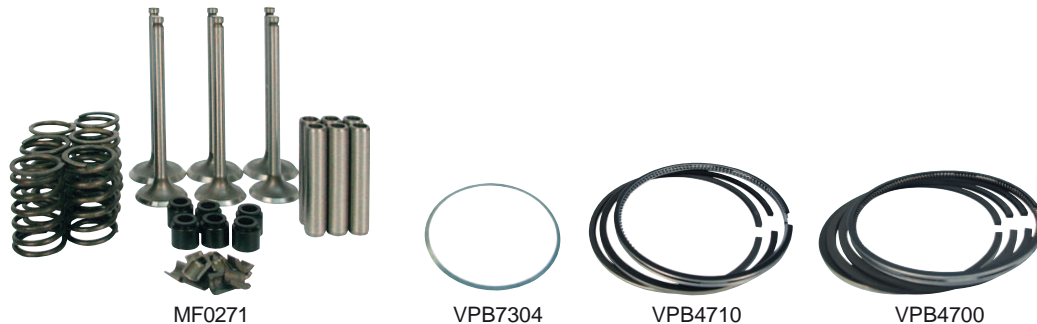

MF0271

VPB7304

VPB4710

VPB4700

TRAKTORI-MALLI	MOOTTORI-TYYPPI	SYLINTERI-PUTKI-SARJA (m)	SYLINTERIPUTKEN SOVITUSLEVY	RENGAS-SARJA 3-renkainen	RENGAS-SARJA 4-renkainen	
2 sylinteriset D2506, D3006	F2L912	VPB9670 02925955	VPB7304 (b) 02137256	VPB7305 (c) 02232963	VPB4710 04156566	VPB4700 02233074
D2807, D3607	F2L912	VPB9670 02925955	VPB7304 (b) 02137256	VPB7305 (c) 02232963 VPB7307 (e) 02239331	VPB4710 04156566	VPB4700 02233074
3 sylinteriset D4006, D4506 D5006, D5206	F3L912	VPB9670 02925955	VPB7304 (b) 02137256	VPB7305 (c) 02232963	VPB4710 04156566	VPB4700 02233074
D4007, D4507 D4507C, D4807 D4807C, D5207 D5207C	F3L912	VPB9670 02925955	VPB7304 (b) 02137256	VPB7305 (c) 02232963 VPB7307 (e) 02239331	VPB4710 04156566	VPB4700 02233074
Intrac 2002	F3L912	VPB9670 02925955	VPB7304 (b) 02137256	VPB7305 (c) 02232963	VPB4710 04156566	VPB4700 02233074
DX3.10SC DX3.10V, DX3.30SC	F3L912	VPB9670 02925955	VPB7304 (b) 02137256	VPB7305 (c) 02232963 VPB7307 (e) 02239331	VPB4710 04156566	VPB4700 02233074
D6007, D6007C DX3.50SC	F3L912	VPB9671 02928137	VPB7304 (b) 02137256	VPB7305 (c) 02232963 VPB7307 (e) 02239331	VPB4720 04152185	
4 sylinteriset DX4.51, DX4.61 DX4.71	BF4L913	VPB9672 02925624	VPB7304 (b) 02137256	VPB7305 (c) 02232963 VPB7307 (e) 02239331		VPB4730 02235561
DX4.50, DX4.70	BF4L913T		VPB7304 (b) 02137256	VPB7305 (c) 02232963 VPB7307 (e) 02239331		
D5506, D6006 D6206, D6806 D7006, D7206	F4L912	VPB9670 02925955	VPB7304 (b) 02137256	VPB7305 (c) 02232963	VPB4710 04156566	VPB4700 02233074
D6207C, D6507C D6807C, D6907C D7007, D7007C D7207, D7207C	F4L912	VPB9670 02925955	VPB7304 (b) 02137256	VPB7305 (c) 02232963 VPB7307 (e) 02239331	VPB4710 04156566	VPB4700 02233074
Intrac 2003	F4L912	VPB9670 02925955	VPB7304 (b) 02137256	VPB7305 (c) 02232963	VPB4710 04156566	VPB4700 02233074
Intrac 2004 DX3.60SC DX3.65SC	F4L912	VPB9670 02925955	VPB7304 (b) 02137256	VPB7305 (c) 02232963 VPB7307 (e) 02239331	VPB4710 04156566	VPB4700 02233074
DX3.70SC DX4.10	F4L912	VPB9670 02925955	VPB7304 (b) 02137256	VPB7305 (c) 02232963 VPB7307 (e) 02239331	VPB4710 04156566	VPB4700 02233074
D7807 DX80	F4L913		VPB7304 (b) 02137256	VPB7305 (c) 02232963 VPB7307 (e) 02239331	VPB4720 04152185	VPB4730 02235561

Katso huomautukset sivulta K1.05

K1.04

Alkuperäisnumerot ovat ainoastaan vertailua varten, eivätkä tarkoita, että tuotteet ovat alkuperäisiä.
Taulukoissa esiintyvät kuvat ovat viitteellisiä.

25.07.2008

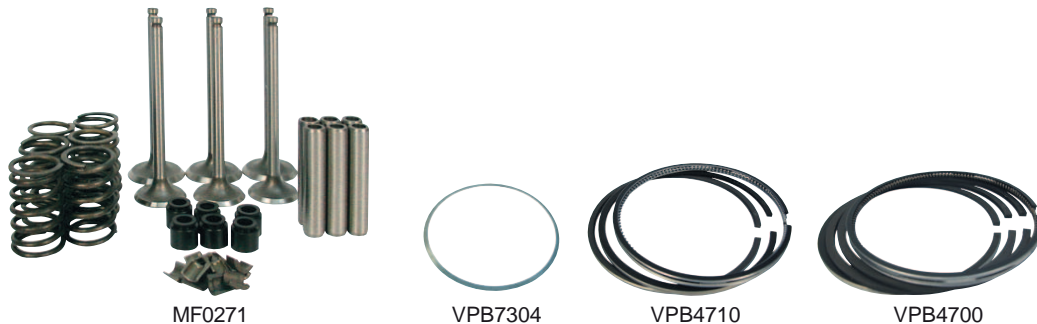

MF0271

VPB7304

VPB4710

VPB4700

TRAKTORI-MALLI	MOOTTORI-TYYPPI	SYLINTERI-PUTKI-SARJA (m)	SYLINTERIPUTKEN SOVITUSLEVY	RENGAS-SARJA 3 kpl	RENGAS-SARJA 4 kpl
4 sylinteriset jatkuu DX86, DX92	F4L913	VPB9672 02925955	VPB7304 (b) 02137256	VPB7305 (c) 02232963 VPB7307 (e) 02239331	VPB4730 02235561
DX3.80SC	F4L913	VPB9671 (g) 02928137	VPB7304 (b) 02137256	VPB7305 (c) 02232963 VPB7307 (e) 02239331	VPB4720 04152185
DX3.90FS DX3.90SC	F4L913	VPB9671 02928137	VPB7304 (b) 02137256	VPB7305 (c) 02232963 VPB7307 (e) 02239331	VPB4720 04152185
DX4.30	F4L913	VPB9671 02928137	VPB7304 (b) 02137256	VPB7305 (c) 02232963 VPB7307 (e) 02239331	VPB4720 04152185 VPB4730 02235561
DX4.31	F4L913	VPB9671 02928137	VPB7304 (b) 02137256	VPB7305 (c) 02232963 VPB7307 (e) 02239331	VPB4720 04152185
5 sylinteriset DX85, DX90	F5L912	VPB9670 02925955	VPB7304 (b) 02137256	VPB7305 (c) 02232963 VPB7307 (e) 02239331	VPB4710 04156566 VPB4700 02233074
6 sylinteriset D13006	BF6L912		VPB7304 (b) 02137256	VPB7305 (c) 02232963	
DX140, DX160 DX145	BF6L913		VPB7304 (b) 02137256	VPB7305 (c) 02232963	
DX6.50	BF6L913		VPB7304 (b) 02137256	VPB7305 (c) 02232963 VPB7307 (e) 02239331	
DX7.10	BF6L913		VPB7304 (b) 02137256	VPB7305 (c) 02232963 VPB7307 (e) 02239331	
D8006, D10006 DX110	F6L912	VPB9670 02925955	VPB7304 (b) 02137256	VPB7305 (c) 02232963	VPB4710 04156566 VPB4700 02233074
DX6.05, DX6.10	F6L912	VPB9670 02925955	VPB7304 (b) 02137256	VPB7305 (c) 02232963 VPB7307 (e) 02239331	VPB4710 04156566 VPB4700 02233074
DX120	F6L913		VPB7304 (b) 02137256	VPB7305 (c) 02232963	VPB4720 04152185 VPB4730 02235561
DX6.30	F6L913	VPB9671 02928137	VPB7304 (b) 02137256	VPB7305 (c) 02232963 VPB7307 (e) 02239331	VPB4720 04152185

b - 0,2 mm (0,0079 in)
c - 0,5 mm (0,0197 in)
e - 1,0 mm (0,0394 in)

g - →7304956
m - sisältää 1 x sylinteri, mäntä ja renkaat

K1.05

25.07.2008



TRAKTORI- MALLI	MOOTTORI- TYYPPI	TYÖNTÖTANGON SUOJAPUTKEN TIIVISTE
2 sylinteriset D2506, D3006, D2807, D3607	F2L912	VPA5043 02232840
3 sylinteriset D4006, D4506, D4007, D4507, D4807, D5207, D4507C, D4807C, D5207C	F3L912	VPA5043 02232840
Intrac 2002, DX3.10SC, DX3.10V, DX3.30SC	F3L912	VPA5043 02232840
D6007, D6007C DC3.50SC	F3L913	VPA5043 02232840
4 sylinteriset DX4.51, DX4.61, DX4.71	BF4L913	VPA5043 02232840
DX4.50, DX4.70	BF4L913T	VPA5043 02232840
D5506, D6006, D6206, D6806, D7006, D7206, D6207C, D6507C, D6907C, D6807C	F4L912	VPA5043 02232840
D7007, D7207, D7007C, D7207C, Intrac 2003, Intrac 2004	F4L912	VPA5043 02232840
DX3.60SC, DX3.65SC DX3.70SC, DX4.10	F4L912	VPA5043 02232840
D7807, DX80, DX86, DX92, DX3.80SC, DX3.90FS, DX3.90SC, DX4.30, DX4.31	F4L913	VPA5043 02232840
5 sylinteriset DX85, DX90	F5L912	VPA5043 02232840
6 sylinteriset D13006	BF6L912	VPA5043 02232840
DX140, DX160, DX145, DX6.50, DX7.10	BF6L913	VPA5043 02232840
D8006, D10006, DX110, DX120, DX6.05, DX6.10	F6L912	VPA5043 02232840
DX6.30	F6L913	VPA5043 02232840

K1.06

Alkuperäisnumerot ovat ainoastaan vertailua varten, eivätkä tarkoita, että tuotteet ovat alkuperäisiä.
Taulukoissa esiintyvät kuvat ovat viitteellisiä.

25.07.2008



VPB7016



VPC2330

TRAKTORI-MALLI	MOOTTORI-TYYPPI	KIERTO-KANGEN PUSLA	KIERTOKANGEN LAAKERI STD pari
2 cylinders D2506, D3006 D2807, D3607	F2L912	VPB7016 03371612	VPC2330 02137750
3 cylinders D4006, D4506 D5206, D5006	F3L912	VPB7016 03371612	VPC2330 02137750
D4007, D4507, D4807, D5207, D4507C, D4807C, D5207C	F3L912	VPB7016 03371612	VPC2330 02137750
Intrac 2002, DX3.10SC, DX3.30SC, DX3.10V	F3L912	VPB7016 03371612	VPC2330 02137750
D6007, D6007C DX3.50SC	F3L913	VPB7016 03371612	VPC2330 02137750
4 cylinders DX4.51, DX4.61 DX4.71	BF4L913	VPB7016 03371612	VPC2330 02137750
DX4.50, DX4.70 DX4.71	BF4L913T	VPB7016 03371612	VPC2330 02137750
D5506, D6006, D6206, D6806, D7006, D7206	F4L912	VPB7016 03371612	VPC2330 02137750
D6207C, D6507C D6807C, D6907C D7007, D7007C D7207, D7207C	F4L912	VPB7016 03371612	VPC2330 02137750
Intrac 2003 Intrac 2004	F4L912	VPB7016 03371612	VPC2330 02137750
DX3.60SC, DX3.65SC, DX3.70SC, DX4.10	F4L912	VPB7016 03371612	VPC2330 02137750
D7807, DX80, DX86, DX92, DX3.80SC, DX3.90SC, DX3.90FS, DX4.30, DX4.31	F4L913	VPB7016 03371612	VPC2330 02137750
5 cylinders DX85, DX90	F5L913	VPB7016 03371612	VPC2330 02137750
6 cylinders DX140, DX145, DX160, DX6.50, DX7.10	BF6L913	VPB7017 02138563	VPC2340 02235183
D8006, D10006, DX110, DX6.05, DX6.10	F6L912	VPB7016 03371612	VPC2330 02137750
DX120, DX6.30	F6L913	VPB7016 03371612	VPC2330 02137750

25.07.2008

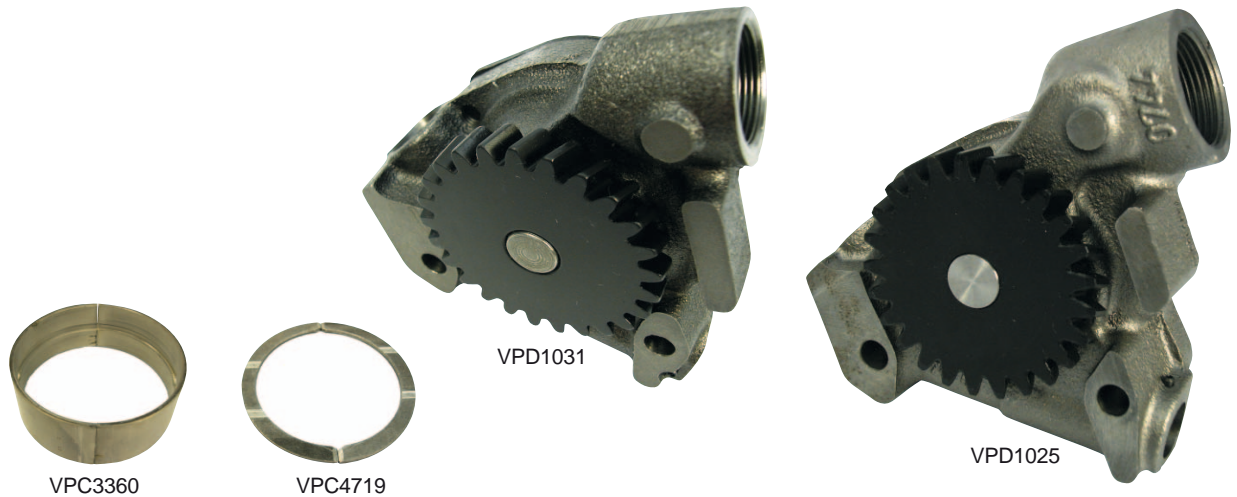

TRAKTORI- MALLI	MOOTTORI- TYYPPI	RUNKO- LAAKERI- PARI STD	PÄITÄISLAAKERIPARI		ÖLJY- PUMPPU
			ETU	TAKA	
3 sylinteriset					
D4006, D4506 D5006, D5206	F3L912	VPC3360 (q) 03362379	VPC4719 02230181	VPC4716 02230170	VPD1031 04158299
D4007, D4507 D4807, D5207	F3L912	VPC3360 (q) 03362379	VPC4719 02230181	VPC4716 02230170	VPD1031 04158299
D4507C, D4807C D5207C	F3L912	VPC3360 (q) 03362379	VPC4719 02230181	VPC4716 02230170	VPD1031 04158299
Intrac 2002	F3L912	VPC3360 (q) 03362379	VPC4719 02230181	VPC4716 02230170	VPD1031 04158299
DX3.10SC	F3L912	VPC3360 (q) 03362379	VPC4719 02230181	VPC4716 02230170	VPD1031 04158299
DX3.10V DX3.30SC	F3L912	VPC3360 (q) 03362379	VPC4719 02230181	VPC4716 02230170	VPD1031 04158299
D6007, D6007C	F3L912	VPC3360 (q) 03362379	VPC4719 02230181	VPC4716 02230170	VPD1031 04158299
DX3.50SC	F3L913	VPC3360 (q) 03362379	VPC4719 02230181	VPC4716 02230170	VPD1031 04158299
4 sylinteriset					
DX4.51, DX4.61 DX4.71	BF4L913	VPC3360 (r) 03362379	VPC4719 02230181	VPC4716 02230170	
DX4.50, DX4.70	BF4L913T	VPC3360 (r) 03362379	VPC4719 02230181	VPC4716 02230170	VPD1025 (m) 04158341
D5506, D6006 D6206, D6806 D7006, D7206	F4L912	VPC3360 (r) 03362379	VPC4719 02230181	VPC4716 02230170	VPD1031 04158299
D6207C, D6507C D7007C, D7207	F4L912	VPC3360 (r) 03362379			VPD1031 04158299
D6807C D6907C, D7007 D7207C	F4L912	VPC3360 (r) 03362379			VPD1031 04158299
Intrac 2003	F4L912	VPC3360 (r) 03362379	VPC4719 02230181	VPC4716 02230170	VPD1031 04158299
Intrac 2004	F4L912	VPC3360 (r) 03362379			VPD1031 04158299
DX3.60SC DX3.65SC DX3.70SC	F4L912	VPC3360 (r) 03362379			VPD1031 04158299
DX4.10	F4L912	VPC3360 (r) 03362379	VPC4719 (l) 02230181	VPC4716 (l) 02230170	VPD1025 04158341

k - →7615055
l - 7618130→
m - →7014590
q - 4 paria/traktori
r - 5 paria/traktori

K1.08

Alkuperäisnumerot ovat ainoastaan vertailua varten, eivätkä tarkoita, että tuotteet ovat alkuperäisiä.
Taulukoissa esiintyvät kuvat ovat viitteellisiä.

25.07.2008

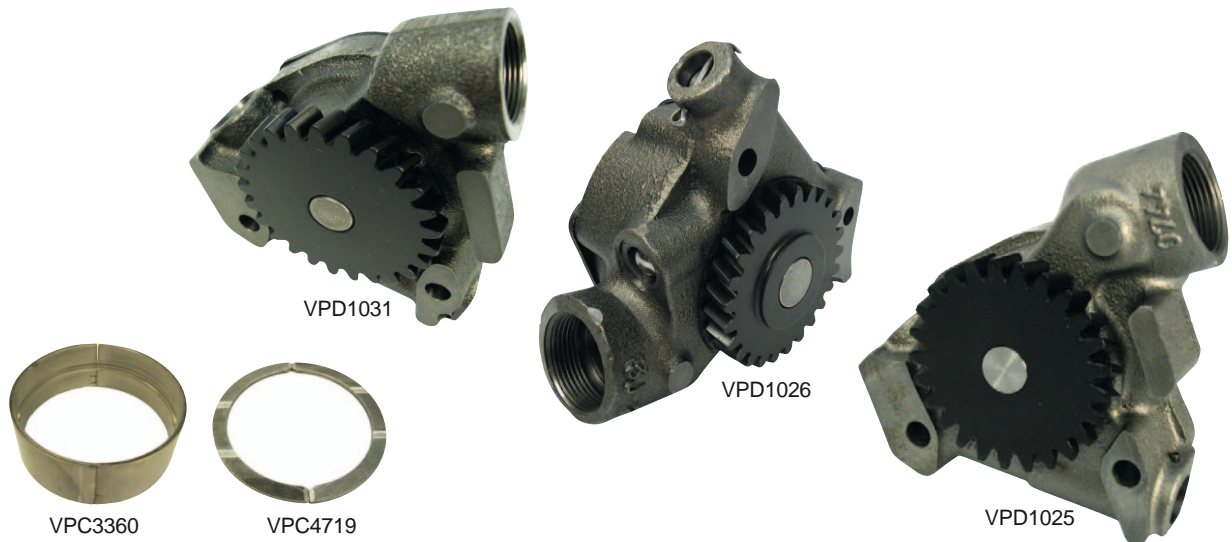

TRAKTORI- MALLI	MOOTTORI- TYYPPI	RUNKO- LAAKERI- PARI STD	PÄITÄISLAAKERIPARI		ÖLJY- PUMPPU
			ETU	TAKA	
4 sylinteriset jatkuu					
D7807	F4L913	VPC3360 (r) 03362379	VPC4719 02230181	VPC4716 02230170	VPD1025 04158341
DX80, DX86 DX92	F4L913	VPC3360 (r) 03362379	VPC4719 02230181	VPC4716 02230170	VPD1025 04158341
DX3.80SC DX3.90SC DX3.90FS	F4L913	VPC3360 (r) 03362379	VPC4719 02230181	VPC4716 02230170	VPD1031 04158299
DX4.30, DX4.31	F4L913	VPC3360 (r) 03362379	VPC4719 02230181	VPC4716 02230170	VPD1025 04158341
5 sylinteriset					
DX85, DX90	F5L912	VPC3360 (s) 03362379	VPC4719 02230181	VPC4716 02230170	VPD1025 04158341
6 sylinteriset					
D13006	BF6L912				VPD1025 04158341
DX140, DX145 DX160	BF6L913				
DX6.50 DX7.10	BF6L913				VPD1026 04154885
D8006, D10006	F6L912	VPC3360 (t) 03362379	VPC4719 02230181	VPC4716 02230170	VPD1025 04158341
DX110	F6L912	VPC3360 (t) 03362379	VPC4719 02230181	VPC4716 02230170	VPD1025 04158341
DX120	F6L913	VPC3360 (t) 03362379	VPC4719 02230181	VPC4716 02230170	
DX6.05 DX6.10	F6L912	VPC3360 (t) 03362379	VPC4719 02230181	VPC4716 02230170	VPD1025 04158341
DX6.30	F6L913	VPC3360 (t) 03362379	VPC4719 02230181	VPC4716 02230170	

r - 5 paria/traktori
s - 6 paria/traktori
t - 7 paria/traktori

25.07.2008



VPC5118

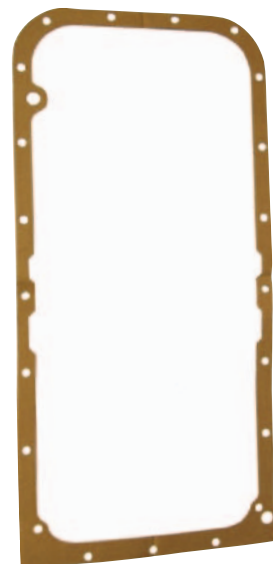

VPC5360

TRAKTORI-MALLI	MOOTTORI-TYYPPI	JAKOPÄÄN HUULI-TIIVISTE	TAKAPÄÄN HUULI-TIIVISTE	TAKA-LAIPAN TIIVISTE	ÖLJY-POHJAN TIIVISTE
2 sylinteriset D2506, D3006 D2807, D3607	F2L912				(a)
3 sylinteriset D4006, D4506 D5006, D5206	F3L912	VPC5118 04150782	VPC5016 04150783	(a)	
D4007, D4507 D4807, D5207	F3L912	VPC5118 04150782	VPC5016 04150783	(a)	
D4507C D4807C, D5207C	F3L912	VPC5118 04150782	VPC5016 04150783	(a)	
Intrac 2002 D4807C	F3L912	VPC5118 04150782	VPC5016 04150783	(a)	(a)
DX3.10SC DX3.30SC	F3L912	VPC5118 04150782	VPC5016 04150783	(a)	
D6007, D6007C	F3L913	VPC5118 04150782	VPC5016 04150783	VPD5365 03362337	
DX3.50SC	F3L913	VPC5118 04150782	VPC5016 04150783	VPD5365 03362337	
4 sylinteriset DX4.51 DX4.61, DX4.71	BF4L913		VPC5016 04150783	VPD5365 03362337	VPC5360 03362574
DX4.50, DX4.70	BF4L913T	VPC5118 04150782	VPC5016 04150783	VPD5365 03362337	VPC5360 03362574
D5506, D6006 D6206, D6806	F4L912	VPC5118 04150782	VPC5016 04150783	(a)	VPC5360 03362574
D7006	F4L912	VPC5118 04150782		(a)	(a)
D7206	F4L912	VPC5118 04150782	VPC5016 04150783	(a)	VPC5360 03362574
D6207C, D6507C D6807C, D6907C	F4L912	VPC5118 04150782	VPC5016 04150783	VPD5365 03362337	VPC5360 03362574
D7007, D7007C D7207, D7207C	F4L912	VPC5118 04150782	VPC5016 04150783	VPD5365 03362337	VPC5360 03362574
Intrac 2003	F4L912			(a)	(a)
Intrac 2004	F4L912	VPC5118 04150782	VPC5016 04150783	(a)	VPC5360 03362574
DX3.60SC, DX3.65SC, DX3.70SC, DX4.10	F4L912	VPC5118 04150782	VPC5016 04150783	VPD5365 03362337	VPC5360 03362574
D7807	F4L913	VPC5118 04150782	VPC5016 04150783	VPD5365 03362337	VPC5360 03362574

a - käytä tiivisteliimaa

02.03.2007



VPC5118

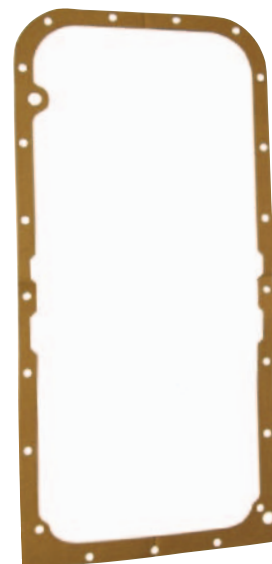

VPC5360

TRAKTORI-MALLI	MOOTTORI-TYYPPI	JAKOPÄÄN HUULI-TIIVISTE	TAKAPÄÄN HUULI-TIIVISTE	TAKA-LAIKAN TIIVISTE	ÖLJY-POHJAN TIIVISTE
4 sylinteriset jatkuu DX80, DX86 DX92	F4L913	VPC5118 04150782	VPC5016 04150783	VPD5365 03362337	VPC5360 03362574
DX3.80SC DX3.90FS DX3.90SC	F4L913	VPC5118 04150782	VPC5016 04150783	VPD5365 03362337	VPC5360 03362574
DX4.30 DX4.31	F4L913	VPC5118 04150782	VPC5016 04150783	VPD5365 03362337	VPC5360 03362574
5 sylinteriset DX85, DX90	F5L912	VPC5118 04150782	VPC5016 04150783	(a)	
6 sylinteriset D13006	BF6L912	VPC5118 04150782	VPC5016 04150783	(a)	
DX140, DX160	BF6L913	VPC5118 04150782	VPC5016 04150783	(a)	
DX145	BF6L913	VPC5118 04150782	VPC5016 04150783	(a)	
DX6.50	BF6L913	VPC5118 04150782	VPC5016 04150783	VPD5365 03362337	
DX7.10	BF6L913	VPC5118 04150782	VPC5016 04152349	VPD5365 03362337	
D8006, D10006	F6L912	VPC5118 04150782	VPC5016 04150783	(a)	
DX110	F6L912	VPC5118 04150782	VPC5016 04150783	(a)	
DX6.05 DX6.10	F6L912	VPC5118 04150782	VPC5016 04152349	VPD5365 03362337	
DX120	F6L913	VPC5118 04150782	VPC5016 04150783	(a)	
DX6.30	F6L913	VPC5118 04150782	VPC5016 04152349	VPD5365 03362337	

a - käytä tiivisteliimaa

21.09.2009

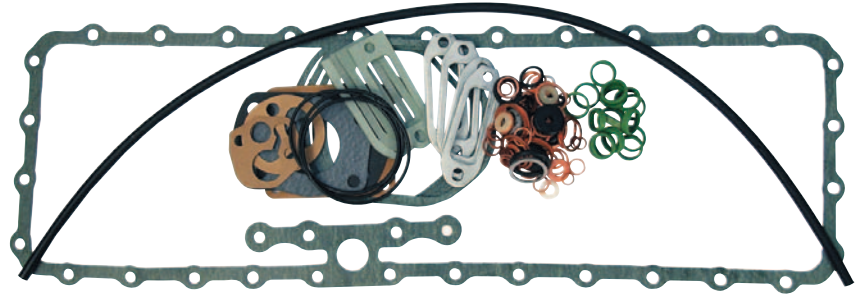

VPA4417



VPA4039



VPA4349



VPA4531

TRAKTORI-MALLI	MOOTTORI-TYYPPI	TIIVISTESARJA YHTEEN SYLINTERIIN	TÄYDELLINEN TIIVISTESARJA (a)	KANNEN-TIIVISTERENGAS	VENTTIILIKANNEN TIIVISTE
2 sylinteriset D2506, D3006 D2807, D3607	F2L912	VPA4039 02910048		VPA4349 04157654	VPA4531 04157234
3 sylinteriset D4006, D4007, D4506, D4507, D4507C, D4807, D4807C, D5006, D5206, D5207, D5207C, Intrac 2002, DX3.10SC, DX3.10V, DX3.30SC	F3L912	VPA4039 02910048	VPA4413 02910182	VPA4349 04157654	VPA4531 04157234
D6007, D6007C DX3.50SC	F3L913	VPA4039 02910048		VPA4349 04157654	VPA4531 04157234
4 sylinteriset DX4.51 DX4.61, DX4.71	BF4L913	VPA4039 02910048		VPA4349 04157654	VPA4531 04157234
DX4.50 DX4.70	BF4L913T	VPA4039 02910048		VPA4349 04157654	VPA4531 04157234
D5506, D6006 D6206, D6207C, D6507C, D6806, D6807C, D6907C, D7006, D7007, D7007C, D7206, D7207, D7207C, Intrac 2003, Intrac 2004, DX3.60SC, DX3.65SC, DX3.70SC, DX4.10	F4L912	VPA4039 02910048		VPA4349 04157654	VPA4531 04157234
D7807, DX80, DX86, DX92, DX3.80SC, DX3.90FS, DX3.90SC, DX4.30, DX4.31	F4L913	VPA4039 02910048	VPA4417 02911535	VPA4349 04157654	VPA4531 04157234
5 sylinteriset DX85, DX90	F5L912	VPA4039 02910048		VPA4349 04157654	VPA4531 04157234
6 sylinteriset D13006	BF6L912	VPA4039 02910048		VPA4349 04157654	VPA4531 04157234
DX140, DX160, DX145, DX6.50, DX7.10	BF6L913	VPA4039 02910048	VPA4419 02910279	VPA4349 04157654	VPA4531 04157234
D8006, D10006 DX110, DX6.05, DX6.10	F6L912	VPA4039 02910048		VPA4349 04157654	VPA4531 04157234
DX120, DX6.30	F6L913	VPA4039 02910048		VPA4349 04157654	VPA4531 04157234

a - ei sisällä kannentiivisterengasta eikä öljypohjan tiivistettä

K1.12

Alkuperäisnumerot ovat ainoastaan vertailua varten, eivätkä tarkoita, että tuotteet ovat alkuperäisiä. Taulukoissa esiintyvät kuvat ovat viitteellisiä.

21.09.2009



STARTTIMOOTTORI

ST0219

- sopii: 911 ja 912
- vaihtoehto **SM2503**

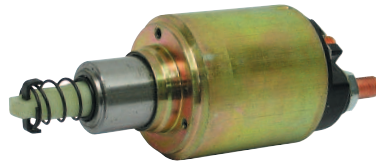

STARTTIMOOTTORIN SOLENOIDI

VPF2215

- 01307762
- 2,7kW starttiin



VIRTALUKKO

- sopii: DX80, 90, 92, 120, 3.50, 4.10, 4.30, 4.50, 4.70, 5.30, 5.50, 5.70, 6.05, 6.10, 6.30

ST0178

ST0178A

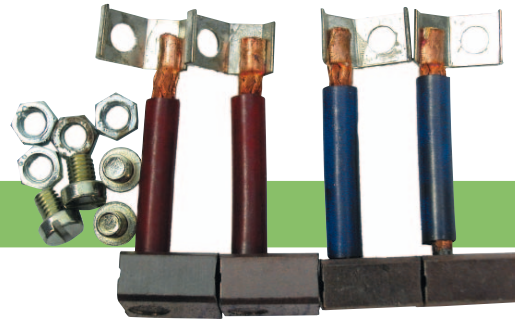

STARTTIMOOTTORIN HIILISARJA

VPF2613

- 01309823
- 2,7 kW starttiin

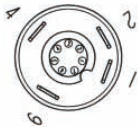
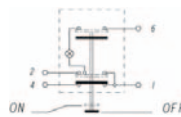

PYSÄKÖINTI PAINOKYTKIN

ST7030

- D65 07C, DX4.10, DX4.30, DX4.50, DX4.70, DX6.30, DX6.50, DX160, DX80, DX86, DX92

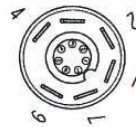
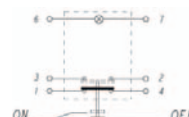

NELIVETO PAINOKYTKIN

ST7031

- DX4.10, DX4.30, DX4.50, DX4.70, DX6.30, DX6.50, DX160

04.03.2011

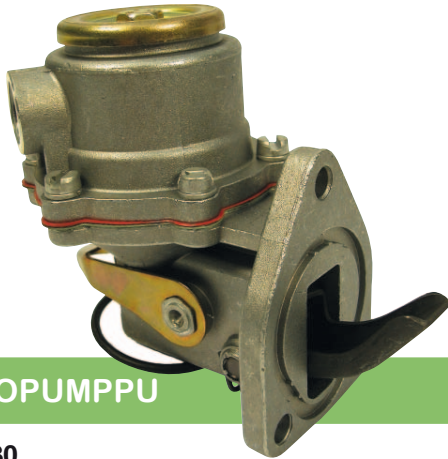

SIIRTOPUMPPU

VPD3030

02100087, 02134511, 02239550, 04150197, 04157603,
04167698, 04230566, 04231021
- moottorityytit: FL812, FL912, FL913, BFL912, BFL913



KORJAUSSARJA

VPD3211

04157606
- "Pierburg"-pumpulle



HEHKUTULPPA

T6960

01161134
01180433
- FL912, FL913
- sarjat: "06", "07", "DX"
- kierre M20 x 1,5 mm
- jännite 9,5V

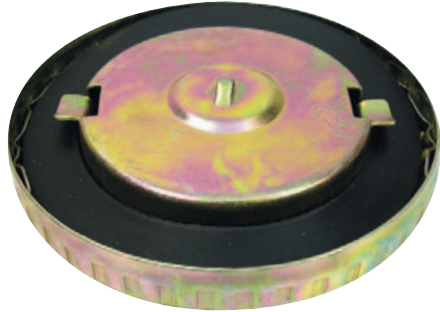

POLTTOAINETANKIN KANSI

VPC4517

0123003

01244823

- 10006, 13006, 2506, 3006, 4006, 4007, 4506, 4507, 4507C, 4807, 5006, 5206, 5207, 5207C, 5506, 6.06, 6006, 6007, 6007C, 6206, 6207, 6207C, 6507, 6507C, 6806, 6807, 6807C, 6907, 6907C, 7006, 7007, 7007C, 7206, 7207, 7207C, 7807, 7807C, 8006, DX110, DX120, DX140, DX145, DX160, DX230, DX250, DX6.10, DX6.30, DX6.50, DX7.10, DX85, DX90, INtrac 2002, INtrac 2003, INtrac 2004, INtrac 6.05, INtrac 6.30, INtrac 6.60



TIIVISTE

T0402

01457647

- koko 10x21x2,0 mm

T0400

- koko 8x11x1 mm



SUUTINKÄRKI

SD71191

DLLA149S774

- 433271376, 02233086, 04152901, 04157220, 09946411, 2506, 3006, 4506, 5006, 5206, 6206, 6806, 7206, 8006, 10006 (7/78-), 2807, 3607, 4007, 4507, 4807, 5207, 6207, 6507, 6807, 6907, 7007, 7207, 7807, DX80, DX85, DX86, DX92, DX90, DX110, DX120 (7/78-), DX3.10, 3.30, 3.50, 3.60, 3.65, 3.70, 3.80, DX4.10, 4.30, 4.50, 4.70, DX6.05, 6.10, 6.30, Agrostar 6.21, Agroprima 4.51, 4.56, 6.06, 6.16, Agroxtra 4.07, 4.47, 4.57, 6.07



ÖLJYKELLO

T6962

01176023, 01168501, 01111021, 01179547

- kierre M10 x 1

- kaikki mallit

Katso tuulettimen hihnojen
vertailutaulukko
Tarvikeluettelon sivulta T6.16c.



VPE6058



VPE6062

TRAKTORI- MALLI	MOOTTORI- TYYPPI	TUULETTAJAN HIHNA
3-sylinteriset D4006, D4007, D4506, D4507, D4507C, D4807, D4807C D5006, D5206, D5207, D5207C	F3L912	AVX10-1500 02235056
DX3.10SC, DX3.30SC	F3L912	AVX10-1600 01175765
DX3.10V	F3L912	AVX10-1475 02235256
D6007, D6007C	F3L913	AVX10-1500 (f) AVX10-1475 (h)
DX3.50SC	F3L913	AVX10-1600 (a) AVX10-1525 (h)
4-sylinteriset DX4.51, DX4.61, DX4.71	BF4L913	VPE6066 02235265
D5506, D6206	F4L912	AVX10-1500 02235056
D6006, D6806, D7006, D7206	F4L912	AVX10-1500 VPE6063 (j)
D6207C, D6507C, D6807C, D6907C, D7007, D7207, D7007C, D7207C	F4L912	AVX10-1500 (f) VPE6063 (h)
DX4.50	BF4L913T	VPE6062 04154525
DX4.70	BF4L913T	VPE6063 VPE6062 (k)
DX3.60SC DX3.65SC DX3.70SC	F4L912	AVX10-1475 (g) AVX10-1525 (h) AVX10-1500 (i)
D7807	F4L913	AVX10-1500 (f) AVX10-1475 (h)
DX3.80SC,DX3.90FS DX3.90SC,DX4.31	F4L913	AVX10-1600 (g) AVX10-1475 (h) AVX10-1525 (i)
5-sylinteriset DX85, DX90	F5L913	VPE6064 (j) 04154401
6-sylinteriset D8006, D10006 DX110, DX120	F6L912 F6L913	VPE6064 (j) 04154401
DX6.10 DX6.30	F6L912 F6L913	VPE6064 (f, h) VPE6062 (g, i)
DX6.05	F6L912	VPE6066 (g) VPE6062 (i)

a - käytä 2 kpl/tuuletin
f - 33 A laturi
g - 55 A laturi
h - 65 A laturi

i - 95 A laturi
j - hihnasarja
k - jäähdytyslaitteella

04.03.2011

PAKOPUTKET

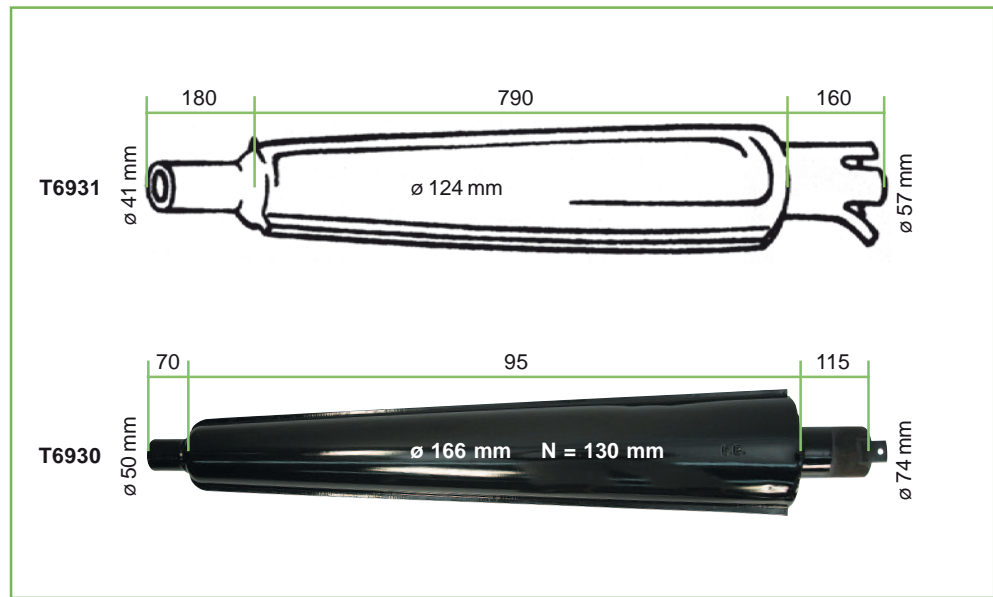

TRAKTORIMALLI	PAKOPUTKI	
Sarja "07", Agroxtra 3.57, 4.07, 4.17, DX3.10, 3.30, 3.50, 3.60, 3.65, 3.70, 3.75, 3.90	T6931 04346150	Alaputken sisähalkaisija 57 mm Kokonaismitta 830 mm
Agroprima 4.31, 4.51, 4.56, 6.06 Agroxtra 4.47, 4.57, 6.07, 6.17 DX4.10, 4.30, 4.50, 4.70, DX6.05	T6930 04345385	Alaputken sisähalkaisija 74 mm Kokonaismitta 950 mm

22.10.2010

HYDRAULIPUMPPU

T6971

01174210

19 + 11 cm³

- sopii DX4.50, 4.51, 4.70, 6.05, 6.06

Agrostar 4.61, 4.71

Agroxtra 4.57, 6.07

DX86, DX86A, DX92, DX92A

- kartioakseli ja kiila

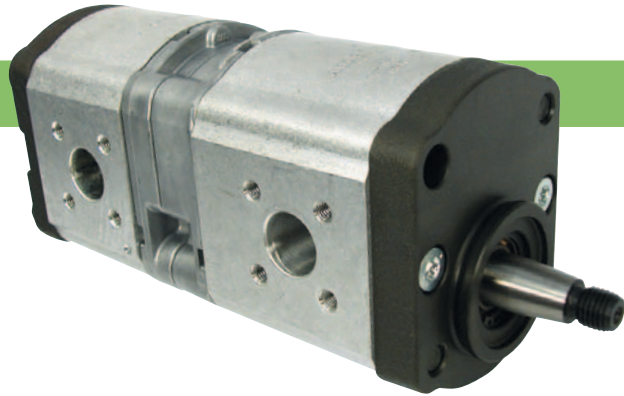

JARRUPALAT

1



2



3



4



Toimitetaan 4 palan sarjoina

TRAKTORI-MALLI	MALLI-NUMERO	TUOTE-NUMERO	MITAT mm
DX85, 90, 92, 110, 120	1	T6950 04314064 04377943	90 x 15 x 73,7
DX4.70 DX6.05, 6.10, 6.30, 6.50	2	T6951 04377345	89,6 x 15 x 74
Agrocompact 3.50S, 3.70V/F, 3.90F, 3.90S Agroxtra 3.57, 4.07, 4.17 DX3.10, 3.30, 3.50, 3.60, 3.65, 3.75, 3.80 DX3.50S, 3.70V/F, 3.90F, 3.90S	3	T6953 04379591	154 x 18 x 90
Transmission avant/Front transmission DX3.10, 3.30, 3.50, 3.70, 3.90 DX4.10, 4.30, 4.50, 4.70 DX6.05	4	T6954 04378840	76,8 x 18,5 x 70,2

04.03.2011

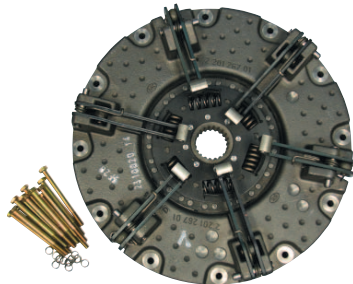

LUK231002014

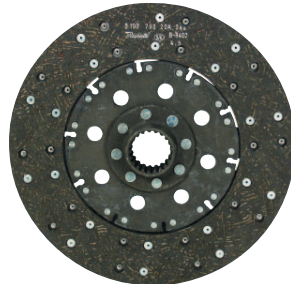

LUK331007116

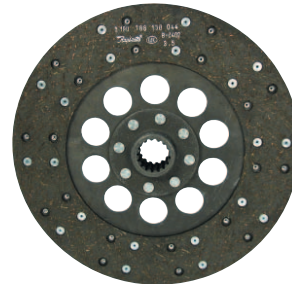

LUK331007216



LUK500005910



LUK500005810



LUK410004500

TRAKTORI-MALLI	TÄYD. KYTKIN-ASETELMA	AJO LEVY JOUSITETTU	V.O.-KYTKIN-LEVY	AJO-PAINE-LAAKERI	V.O.-PAINE-LAAKERI	SILMÄ-LAAKERI
DX 3.30, 3.50, 3.57, 3.65, 3.70, 3.90 Koko 280/280 mm	LUK228000715 (e,1) LUK228000716 (c,1)					
DX 80, 90, 92, 120, 4.10, 4.30, 4.50, 4.70, 5.30, 5.50, 5.70, 6.05, 6.10, 6.30 Koko 310/310 mm	LUK231002014 (a,1) LUK231002016 (c,1)	LUK331007112 (a) LUK331007116 T6901A (c)	LUK331007216 T6902	LUK500005910 (sisä Ø 65 mm) tai LUK500007620 (sisä Ø 55 mm)	LUK500005810 tai L6014-2RS	LUK410004500
DX3.90SC/VC DX5.10 DX3.70SC/VC Koko 310/200 mm	LUK231003111 (c,1)	LUK331006116 (c)	LUK328012216	LUK500007620		LUK410004500

- a - keraaminen 8-lapainen
c - orgaani
e - keraaminen 5-lapainen
1 - ajolevy

VAUHTIPYÖRÄN NAPA

LUK370001810

04411038

- Power Shift -vaihteisto
- sopii: Agrottron-80, 85, 90, 100, 105, 106
- Agrottron-4.70, 4.80, 4.85, 4.90, 4.95, 6.01

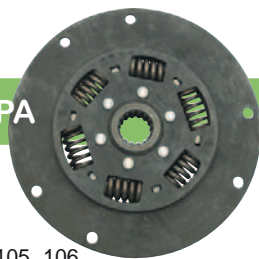

KESKIÖRASVA

LUK414001410

- erityisesti kytkinkeskiöihin ja -akseleihin



KYTKINVAIJERI

T6940

04354988, 04383974, 04396476

- pituus 1250 mm
- sopii sarja "07"
- DX3.10, 3.30, 3.50, 3.60, 3.65, 3.70, 3.80, 3.90
- Agroprima 4.31, 4.51, 4.56, 6.06, 6.16
- Agroxtra 3.57, 4.07, 4.17, 4.47, 4.57, 6.07, 6.17
- Agrocompact 3.30V/F, 3.50S, 3.50V/F, 3.70V/F, 3.90F, 3.90S

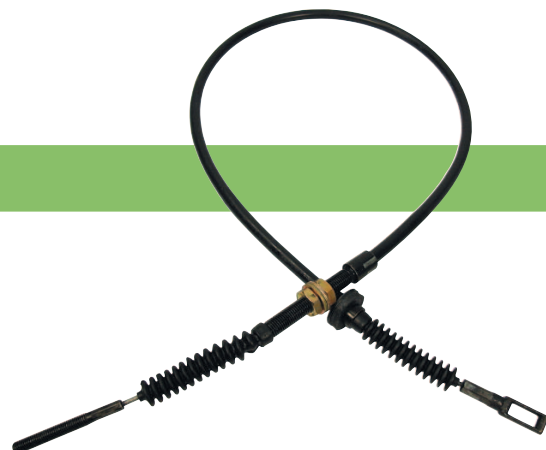

K1.19

20.04.2006



KS0132



KS0135



KS0133



KS0134

TRAKTORI-MALLI	OHJAAMO-TYYPPI	TAKALASIN KAASUSYLINTERI	KATTO-LUUKUN KAASUSYLINTERI	OVEN LASIN KAASUSYLINTERI	ETULASIN KAASUSYLINTERI
DX3.10SC, DX3.30SC, DX3.60SC, DX3.65SC, DX3.50SC, DX3.70SC, DX3.90SC, DX3.50SC, DX3.80SC, DX3.90SC	Star-Cab	T6907 KS0132 04357777	T6908 KS0133 04316669	T6910 KS0134 04373761	T6907 KS0132 04357777
DX4.30, DX4.50, DX4.70, DX6.05, DX6.10, DX6.30, DX6.50, DX7.10, DX4.10	Master-Cab	T6910 KS0134 04373761	T6908 KS0133 04316669	T6911 KS0135 04373763	T6910 KS0134 04373761
DX8.30, DX230, DX250		T6907 KS0132 04357777			
DX85, DX86, DX90	Master-Cab	T6907 KS0132 04357777		T6911 KS0135 04373763	
DX80, DX92, DX120, DX160	Master-Cab	T6907 KS0132 04357777	T6908 KS0133 04316669	T6911 KS0135 04373763	
D4507C, D4807C, D5207C, D6207C, D6507C, D6007C, D6807C, D7007C, D7207C, D7807C, D6907C	Q-Cab		T6908 KS0133 04316669	T6907 KS0132 04357777	T6907 KS0132 04357777
D6807, D7207, D7807		T6908 KS0133 04316669	T6908 KS0133 04316669		T6908 KS0133 04316669



T5387



T5386

TRAKTORI-MALLI	VASEN ULOMPI	VASEN SISEMPI	OIKEA SISEMPI	OIKEA ULOMPI
DX3.10, DX3.30, DX3.60, DX3.50, DX3.65, DX3.70, DX3.65, DX4.30 Agroprima 4.31, 4.51, 4.56 Agroxtra 3.57, 4.07, 4.17, 4.57	T5387 0435 8286	T5386 0435 8287	T5386 0435 8287	T5387 0435 8286
Agroprima 6.06, 6.16 Agroxtra 6.07, 6.17		T5386 0435 8287	T5386 0435 8287	
DX 6.30, DX 6.50 Agroprima 6.06, 6.16 Agroxtra 6.07, 6.17		T5386 0435 8287	T5386 0435 8287	
Agrotron 6.05		F3957792 0441 5654	F3957792 0441 5654	

K1.20

08.05.2009



PYYHKIJÄN SULKA

VLC3225
- 460 mm



PYYHKIJÄN SULKA

VLC3228
- 510 mm



TUULILASILIIÄSARJA

HK269

- annostellaan kylmänä, valumaton
- max. kiinnitysaika 25 min
- ajovalmuisaika 2 h
- sisältö: puhdistusaine 20 ml, puhdistusliina, primer 10 ml, primer-levitin, liima 310 ml

Master Cab DX-sarja

80, 85, 90, 92, 110, 120, 140, 145, 160

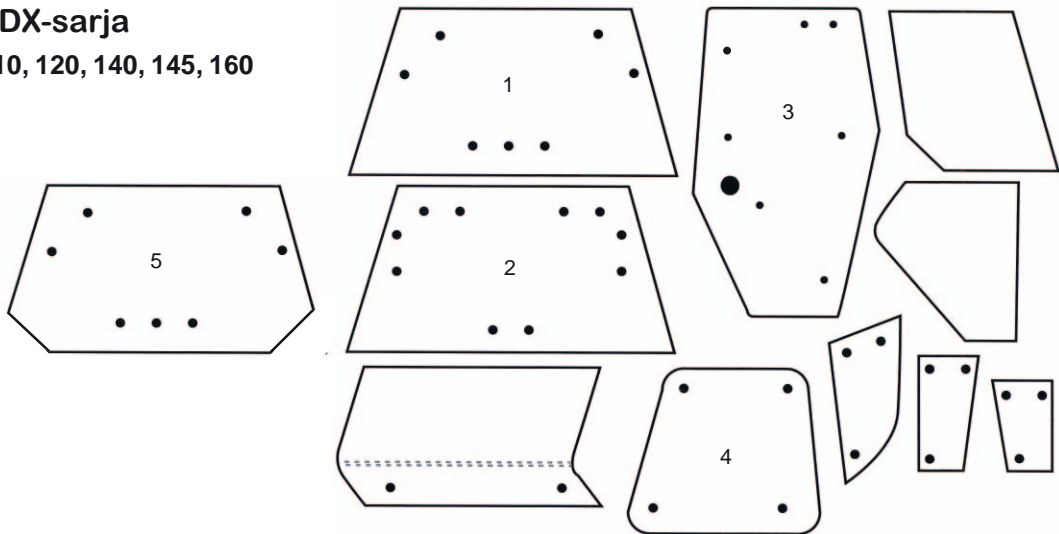

	TUOTE-NRO	LASI	KUVAUS	ALKUPERÄIS- NUMERO	KOKO mm (k ork. x lev. x vahv.)	VÄRI	KIINNITYS
1	T6916	Ylempi taka	7 reikää	4346800	1375 x 691 x 6	kirkas	PK
2	T6974	Tuulilasi	avattava, 10 reikää	4307803	1359 x 692 x 6	kirkas	R/PK
3	T6975	Oven	vas., 8 reikää, kaareva	4347342	1430 x 725 x 6	sävytetty	R/PK
3	T6976	Oven	oik., 8 reikää, kaareva	4347343	1430 x 725 x 6	sävytetty	R/PK
4	T6977	Sivulasi	vas. & oik., 4 reikää	4312038	890 x 645 x 6	kirkas	R/PK
5	T6915 (c)	Taka	7 reikää	4340309	1165 x 688 x 6	kirkas	PK
2	T6974 (b)	Ylempi taka	10 reikää	4314333	1359 x 692 x 6	kirkas	R/PK

a - sopii malleihin 80, 86 ja 92 sekä
85 →7816/0001 ja 7817/0001
90 →7818/0001 ja 7819/0001
110 →7820/0001 ja 7821/0001
120 →7826/0001 ja 7827/0001

b - sopii malleihin 85, 90, 110, 120, 140, 145 ja 160
c - 07 C sarja, molemmat reunat viistetty

Kiinnitystavat: L = liimattu
PK = pulttikiinnitys
K = kehyksellä
T = tiivisteellä
R = reunasuojalla

K1.21

08.05.2009

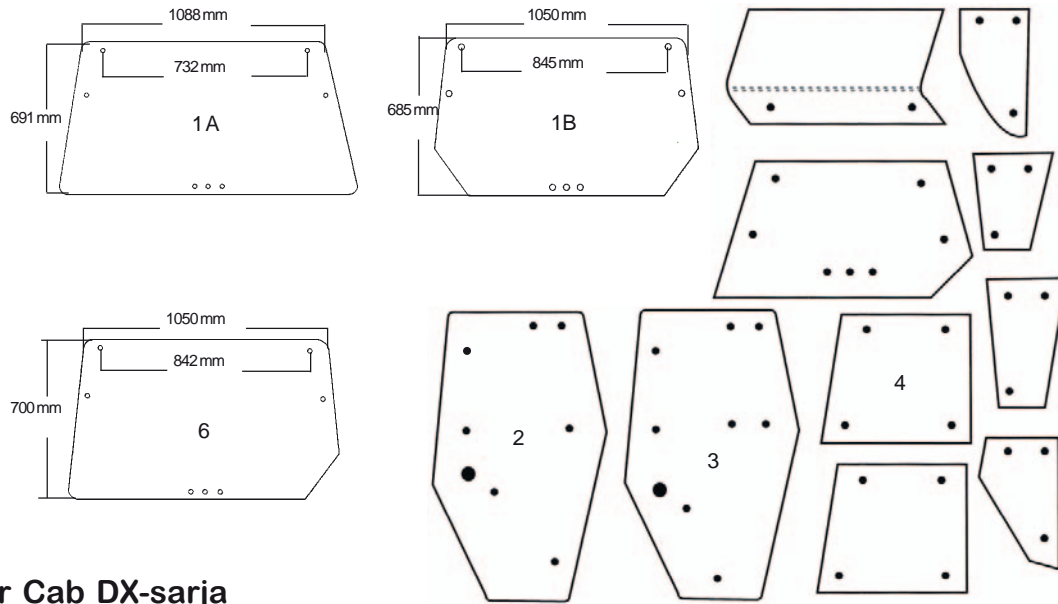

Master Cab DX-sarja

4.10, 4.20, 4.30, 4.50, 4.70, 6.05, 6.10, 6.30, 6.50, 7.10

TUOTE-NRO	LASI	KUVAUS	ALKUPERÄIS-NUMERO	KOKO mm (k ork. x lev. x vahv.)	VÄRI	KIINNITYS
1A	T6916	Ylempi taka	7 reikää	4346800	1375 x 691 x 6	kirkas PK
2	T6975 (a)	Oven	vas., 8 reikää, kaareva	4347342	1430 x 725 x 6	sävytetty R/PK
2	T6976 (a)	Oven	oik., 8 reikää, kaareva	4347343	1430 x 725 x 6	sävytetty R/PK
3	T6978 (b)	Oven	vas., 9 reikää, kaareva	4358529	1430 x 725 x 6	sävytetty R/PK
3	T6979 (b)	Oven	oik., 9 reikää, kaareva	4358530	1430 x 725 x 6	sävytetty R/PK
4	T6977	Sivulasi	vas. & oik., 4 reikää	4312038	890 x 645 x 6	kirkas R/PK
6	T6914	Ylempi taka	7 reikää, viiste	4352383	1232 x 700 x 6	kirkas R/PK
1B	T6915 (c)	Taka	7 reikää	4340309	1165 x 688 x 6	kirkas PK

- a - laseissa nro 2 on yksi reikä oven alaosan kehykselle
 b - laseissa nro 3 on kaksi reikää oven alaosan kehykselle
 c - 07 C sarja, molemmat reunat viistetty

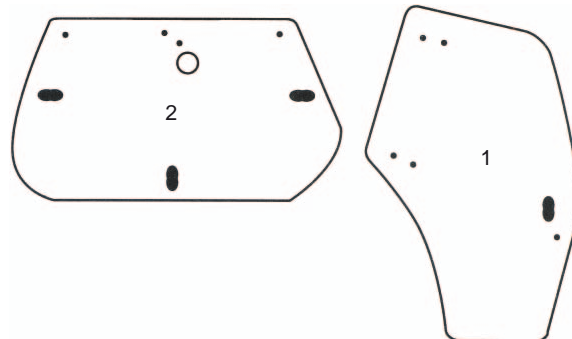

Agrotion

TUOTE-NRO	LASI	KUVAUS	ALKUPERÄIS-NUMERO	KOKO mm (k ork. x lev. x vahv.)	VÄRI	KIINNITYS
1	T6981	Oven	vas., 6 reik., kaareva	4418951	1525 x 1120 x 6	sävytetty PK
2	T6973	Ylempi taka	8 reikää, kaareva	4419379	1420 x 895 x 5	sävytetty PK

Kiinnitystavat: L = liimattu
 PK = pulttikiinnitys
 K = kehyksellä
 T = tiivisteellä
 R = reunasuojalla

K1.22

25.07.2008



ULKOKAHVA

VLD1429

04345504

- "Q"-ohjaamo



SISÄLUKKO

- "Q"-ohjaamo, Master-ohjaamo

Oikea

VLD1438

04339352

Vasen

VLD1436

04339353



LÄMMITYSLAITTEEN MOOTTORI

T4214

- kokonaispituus 260 mm



ETULYHTY

T6919

04301196

- 06 sarjaan

- 40-45 W

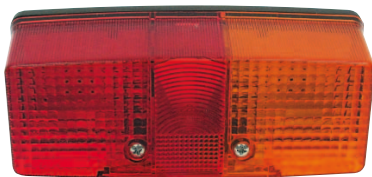

TAKALYHDYT

- DX3.57, DX4.07, DX4.17, DX4.31, DX4.47, DX4.51, DX4.56
- tyyppi "Jokon"
- 158 x 64 mm

Vasen

T6921

04340702

- varalasi **T6923**

Oikea

T6920

04340703

- varalasi **T6922**



TAKALYHDYT

- DX-malleihin
- tyyppi "Jokon"
- 165 x 68 mm

Vasen

T6925

- varalasi **T6927**

Oikea

T6924

- varalasi **T6926**



LASINPYYHKIJÄN MOOTTORI

T6961

04363241

- DX3.10, 3.30, 3.50, 3.60, 3.65, 3.70, 3.80, 3.90SC
DX4.10, 4.30, 4.50, 4.70, DX6.05, 6.10, 6.30, 6.50
Agroprima 4.31, 4.51, 4.56, 6.06, 6.16
Agroxtra 3.57, 4.07, 4.17, 4.47, 4.57, 6.07, 6.17

ETUÄÄRIVALO

T6528

- DX-malleihin
- 125 x 63 mm



26.09.2011



TRAKTORI-MALLI	ÖLJYN-SUODATIN	POLTTO-AINE-SUODATIN	ILMANSUODATIN ULOMPI	ILMANSUODATIN SISEMPI	HYDRAULIIKKA-SUODATIN	SYKLONI TÄYDELLINEN	SYKLONIN LASI
Intrac 2002, Intrac 2003, Intrac 2004	TF4501 DFP552819 01174418	TF6054 DFP553004 01174423	TF2186 04384102	DFP777759 04308634	T6905B 2380014		
Intrac 6.05	TF4057 01174421	TF6054 DFP553004 01174482	TF2197 DFP771561 02165049	TF2197-2 02241329	T6905A 04399525		
Intrac 6.30	TF4109 01174420	TF6054 DFP553004 01174482			T6905A 04399525		
Intrac 6.60	TF4109 01174420	TF6054 DFP553004 01174482	TF2197 DFP771561 02165049	TF2197-2 02241329	T6905A 04399525		
D2506, D3006		TF6065 01174696	TF2186 04384102	DFP777759 04308634	T6905B 02380014	DFH001249 04345068	DFP020227 02315448
D2807, D3607		TF6065 01174696	TF2186 04384102	DFP777759 04308634	T6905B 02380014		
D4006, D4007, D4506 D4507, D4807, D5006, D5206, D5207	TF4501 DFP552819 01174418	TF6054 DFP553004 01174423	TF2186 04384102	DFP777759 04308634	T6905B 02380014	DFH001249 04345068	DFP020227 02315448
D4507C, D4807C D5207C, D6007C	TF4501 DFP552819 01174418	TF6054 DFP553004 01174423	TF2186 04384102	DFP777759 04308634	T6905A 04399525	DFH001249 04345068	DFP020227 02315448
D5506, D6006, D6007, D6206, D6207, D6806, D7006, D7206	TF4501 DFP552819 01174418	TF6054 DFP553004 01174423	TF2186 04384102	DFP777759 04308634	T6905B 02380014	DFH001249 04345068	DFP020227 02315448
D6507, D6807, D6907, D7007, D7207, D7807	TF4501 DFP552819 01174418	TF6054 DFP553004 01174423	TF2186 04384102	DFP777759 04308634	T6905B 02380014	DFH001249 04345068	DFP020227 02315448
D6207C, D6807C	TF4501 DFP552819 01174418	TF6054 DFP553004 01174423	TF2186 04384102	DFP777759 04308634	T6905 04305722	DFH001249 04345068	DFP020227 02315448
D6507C, D6907C, D7007C, D7207C, D7807C	TF4501 DFP552819 01174418	TF6054 DFP553004 01174422	TF2186 04384102	DFP777759 04308634	T6905A 04399525	DFH001249 04345068	DFP020227 02315448
D10006 D80006 D13006	TF4057 01174421	TF6054 DFP553004 01174482	TF2346 04384103	TF2346-2 04308636	T6905B 2380014(-74→)	DFH001249 04345068	DFP020227 02315448
DX36V		TF6065 01174696	TF2186 04384102	DFP777759 04308634			
DX50V, DX55V	TF4501 DFP552819 01174418	TF6054 DFP553004 01174423	TF2186 04384102	DFP777759 04308634			
DX80	TF4501 DFP552819 01174418	TF6054 DFP553004 01174482	TF2346 04384103 TF2327 (j) 04319257	VPD7083 02243522 DFP127787 (j) 04319256	T6905 04305722 T6905A (b) 04399525		

b - imuputki ylhäältä

j - Donaldson-tyyppi

26.09.2011



TRAKTORI-MALLI	ÖLJYN-SUODATIN	POLTTO-AINE-SUODATIN	ILMANSUODATIN ULOMPI	ILMANSUODATIN SISEMPI	HYDRAULIIKKA-SUODATIN	SYKLONI TÄYDELLINEN	SYKLONIN LASI
DX85, DX90, DX110, DX120	TF4057 01174421	TF6054 DFP553004 01174482 01174483	TF2346 04384103 TF2327 (j) 04319257	TF2346-2 04308636 DFP127787 (j) 04319256	T6905 04305722 T6905A (b) 04399525	DFH000820 04318399	DFP016330 02389400
DX86, DX92	TF4501 DFP552819 01174418	TF6054 DFP553004 01174482	TF2346 04384103 TF2327 (j) 04319257	TF2346-2 04308636 DFP127787 (j) 04319256	T6905 04305722 T6905A (b) 04399525		
DX140, DX160 DX145	TF4109 01174420	TF6054 DFP553004 01174482	TF2197 DFP771561 02165049	TF2197-2 02241329	T6905 04305722 T6905A (b) 04399525	DFH000822 04318403	DFP016330 02389400
DX230, DX250	TF4109 01174420 04359771	TF6054 DFP553004 01174482	TF2156 02165059		T6905 04305722 T6905A (b) 04399525		
DX3.10V, DX3.30VF, DX3.50VFS, DX3.70VF, DX3.90FS	TF4501 DFP552819 01174418	TF6054 DFP553004 01174482	TF2186 04384102	VPD7081 02243521	T6905A 04399525	DFH001249 04345068	DFP020227 02315448
DX3.10VC, DX3.30VC, DX3.30SC, DX3.50VC, DX3.60VC	TF4501 DFP552819 01174418	TF6054 DFP553004 01174423	TF2186 04384102	VPD7081 02243521	T6905B 02380014	DFH001249 04345068	DFP020227 02315448
DX3.10SC	TF4501 DFP552819 01174418	TF6054 DFP553004 01174423	TF2186 04384102	VPD7081 02243521	T6905 04305722 T6905A (b) 04399525	DFH001249 04345068	DFP020227 02315448
DX3.50SC, DX3.60SC, DX3.65SC, DX3.65VC, DX3.80SC	TF4501 DFP552819 01174418	TF6054 DFP553004 01174423	TF2186 04384102	VPD7081 02243521	T6905A 04399525	DFH001249 04345068	DFP020227 02315448
DX3.70VC, DX3.90VC	TF4501 DFP552819 01174418	TF6054 DFP553004 01174423	TF2346 04384103 VPD7072 (a) 04353103	VPD7083 02243522 DFP127787 (a) 04319256	T6905B 02380014	DFH001249 04345068	DFP020227 02315448
DX3.70SC, DX3.90SC	TF4501 DFP552819 01174418	TF6054 DFP553004 01174423	TF2346 04384103 VPD7072 (a) 04353103	VPD7083 02243522 DFP127784 (a) 04319256	T6905 04305722 T6905A 04399525	DFH001249 04345068	DFP020227 02315448
DX4.10, DX4.30, DX4.50, DX4.70, DX4.31, DX4.51	TF4501 DFP552819 01174418	TF6054 DFP553004 01174482	TF2346 04384103 VPD7072 (a) 04353103 TF2327 (j) 04319257	VPD7083 02243522 DFP127784 (a,j) 04319256	T6905A 04399525	DFH000820 04318399	DFP016330 02389400

a - imuputki ylhäällä
b - vuodesta -84→
j - Donaldson-tyyppi

K1.25

Alkuperäisnumerot ovat ainoastaan vertailua varten, eivätkä tarkoita, että tuotteet ovat alkuperäisiä. Taulukoissa esiintyvät kuvat ovat viitteellisiä.

26.09.2011



TRAKTORI-MALLI	ÖLJYN-SUODATIN	POLTTO-AINE-SUODATIN	ILMANSUODATIN ULOMPI	ILMANSUODATIN SISEMPI	HYDRAULIIKKA-SUODATIN	SYKLONI TÄYDELLINEN	SYKLONIN LASI
DX6.05	TF4057 01174421	TF6054 DFP553004 01174482	TF2346 04384103 VPD7072 (a) 04353103 TF2327 (j) 04319257	VPD7083 02243522 DFP127784 (a,j) 04319256	T6905A 04399525	DFH000820 04318399	DFP016330 02389400
DX6.06	TF4057 01174421	TF6054 DFP553004 01174482	TF2346 04384103	VPD7083 02243522	T6905A 04399525	DFH000820 04318399	DFP016330 02389400
DX6.10 DX6.30	TF4057 01174421	TF6054 DFP553004 01174482	TF2346 04384103 VPD7072 (a) 04353103 TF2327 (j) 04319257	TF2346-2 04308636 DFP127784 (a,j) 04319256	T6905A 04399525	DFH000820 04318399	DFP016330 02389400
DX6.50	TF4109 01174420	TF6054 DFP553004 01174482	TF2197 (a) DFP771561 02165049	TF2197-2 (a) 02241329	T6905 04305722	DFH000822 04318403	DFP016330 02389400
DX7.10	TF4109 01174420	TF6054 DFP553004 01174482	TF2197 (a) DFP771561 02165049	TF2197-2 (a) 02241329	T6905A 04399525	DFH000822 04318403	DFP016330 02389400
DX8.30	TF4109 01174420	TF6054 DFP553004 01174482	TF2197 DFP771561 02165059		T6905 04305722 T6905A (b) 04399525		

a - imuputki ylhäältä

b - vuodesta -84→

j - Donaldson-tyyppi

OHJAAMON SUODATTIMET

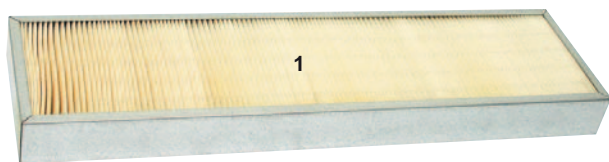

TF21200

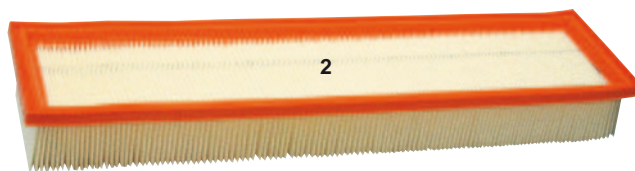

TF21156

SOPIVUUS	TUOTE-NUMERO	PITUUS	MITAT mm LEVEYS	VAHVUUS	KUVA
Puimurit 3370	TF21200	660	176	56	1
Agrotron-sarja	TF21191 4411228	550	75	70	2
DX-sarja	TF21156 43363855 4307641	480	123	57	2

K1.26

Alkuperäisnumerot ovat ainoastaan vertailua varten, eivätkä tarkoita, että tuotteet ovat alkuperäisiä. Taulukoissa esiintyvät kuvat ovat viitteellisiä.